

CLASSIC (FULL FRONT)



621 Series



621T Series

CUSTOM (SEAT CUSHION WITH BASE OPTIONS)



622 Series



622T Series

ARM CAP OPTIONS



Upholstered
(no upcharge)



Wood
(no upcharge)



Thermoform
(no upcharge)



Urethane
(no upcharge)

Specify black, sable or dove.



Solid Surface
\$323

Specify solid surface color.

LEG STYLES



Wood Leg
(standard)

There is no wood trim rail on custom models.



Metal Leg
\$489

Specify silver, black, bronze or gunmetal.



Plinth Base
\$489

Available on Classic models only.



Casters
\$528

Available with or without a table. For table models, specify wood or metal center feet. Casters are intended to aid housekeeping staff with moving when cleaning.

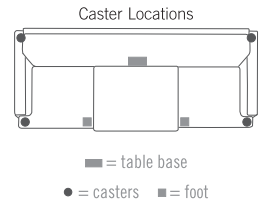

BASE OPTIONS - FOR CUSTOM STYLES ONLY



Ottoman
\$1049

Specify left or right and select wood or urethane handle (as facing).



Drawer - Fabric, Wood or Thermoform
\$420

Specify left, middle or right.

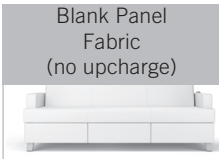

Blank Panel
Fabric
(no upcharge)

Specify left, middle or right.



Blank Panel
Wood or Thermoform
\$111

Specify left, middle or right.

POWER OPTIONS - FOR CLASSIC STYLE WITH TABLE AND CUSTOM STYLE WITH TABLE ONLY



7700001 USB/120V
Outlet \$789

OR



7700002 120V/120V
Outlet \$667



USB/120V Double
Outlet \$1578



120V/120V Double
Outlet \$1334

Available in black or silver. Usable cord length is 9'. Please get facility approval on power options before ordering. Specify right, left, or both. Power units are UL Listed Tamper Resistant outlets.

SLEEP SURFACE OPTIONS

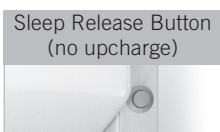

Sleep Release Button
(no upcharge)

Specify dark bronze, light grey or black. Specify right or left (right is default unless otherwise specified).

TABLE OPTIONS

Thermoform Table Top
(no upcharge)



Specify thermoform color.

Solid Surface Table Top



Specify solid surface color.

63"	\$674
66"	\$901
69"	\$1139
72"	\$1281
75"	\$1626
78"	\$1735

Wood Column Skirt
Cap (no upcharge)



Specify wood finish.

Thermoform Column
Skirt Cap (no upcharge)



Specify thermoform color.

Solid Surface Skirt Cap



Specify solid surface color.

63"	\$253
66"	\$332
69"	\$335
72"	\$335
75"	\$414
78"	\$414

Table Release Lever
(no upcharge)



Specify silver, black,
bronze or gunmetal.

OPTIONS LEGEND

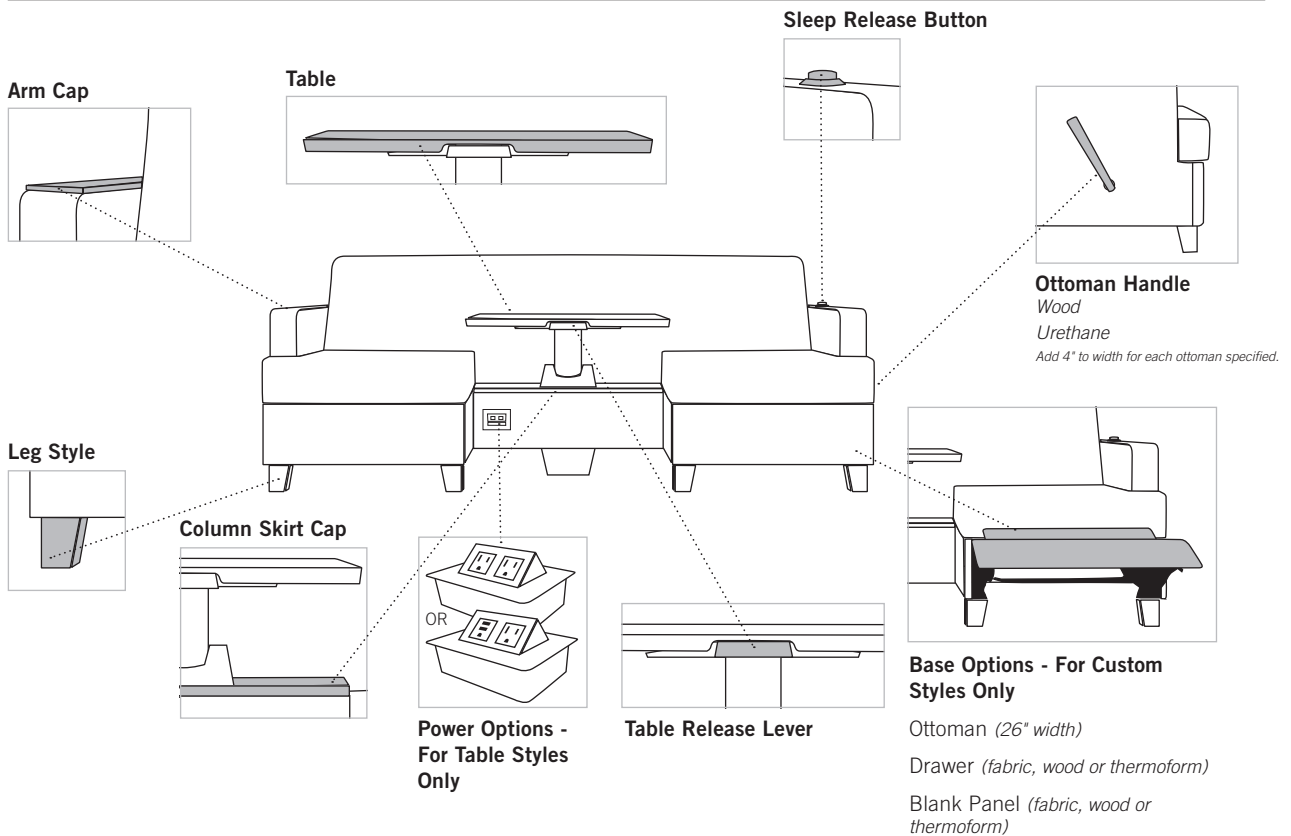

sleepToo® Classic

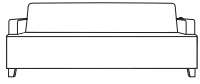

62166 SLEEP SOFA, CLASSIC FRONT, 66" SLEEP SURFACE

W: 74" D: 34" H: 33" SW: 66" SD: 21.5" SH: 18.5" AH: 24.5" WT: 172 lb COM: 8.25 yd WT CAP: 750 lb

ZONE	B/COM	C	D	E	F	G	H	I	J	GENERAL INFORMATION
1	9082	9247	9404	9602	9932	10254	10584	10905	11235	MATERIAL: Maple MOIS. BARR: Included
2	9306	9471	9628	9826	10156	10478	10808	11129	11459	
3	9530	9695	9852	10050	10380	10702	11032	11353	11683	
4	9753	9918	10075	10273	10603	10925	11255	11576	11906	

62169 SLEEP SOFA, CLASSIC FRONT, 69" SLEEP SURFACE

W: 77" D: 34" H: 33" SW: 69" SD: 21.5" SH: 18.5" AH: 24.5" WT: 178 lb COM: 8.25 yd WT CAP: 750 lb

ZONE	B/COM	C	D	E	F	G	H	I	J	GENERAL INFORMATION
1	9201	9366	9523	9721	10051	10373	10703	11024	11354	MATERIAL: Maple MOIS. BARR: Included
2	9428	9593	9750	9948	10278	10600	10930	11251	11581	
3	9654	9819	9976	10174	10504	10826	11156	11477	11807	
4	9881	10046	10203	10401	10731	11053	11383	11704	12034	

62172 SLEEP SOFA, CLASSIC FRONT, 72" SLEEP SURFACE

W: 80" D: 34" H: 33" SW: 72" SD: 21.5" SH: 18.5" AH: 24.5" WT: 184 lb COM: 8.25 yd WT CAP: 750 lb

ZONE	B/COM	C	D	E	F	G	H	I	J	GENERAL INFORMATION
1	9331	9496	9653	9851	10181	10503	10833	11154	11484	MATERIAL: Maple MOIS. BARR: Included
2	9561	9726	9883	10081	10411	10733	11063	11384	11714	
3	9791	9956	10113	10311	10641	10963	11293	11614	11944	
4	10021	10186	10343	10541	10871	11193	11523	11844	12174	

62175 SLEEP SOFA, CLASSIC FRONT, 75" SLEEP SURFACE

W: 83" D: 34" H: 33" SW: 75" SD: 21.5" SH: 18.5" AH: 24.5" WT: 190 lb COM: 8.25 yd WT CAP: 750 lb

ZONE	B/COM	C	D	E	F	G	H	I	J	GENERAL INFORMATION
1	9450	9615	9772	9970	10300	10622	10952	11273	11603	MATERIAL: Maple MOIS. BARR: Included
2	9683	9848	10005	10203	10533	10855	11185	11506	11836	
3	9916	10081	10238	10436	10766	11088	11418	11739	12069	
4	10149	10314	10471	10669	10999	11321	11651	11972	12302	

62178 SLEEP SOFA, CLASSIC FRONT, 78" SLEEP SURFACE

W: 86" D: 34" H: 33" SW: 78" SD: 21.5" SH: 18.5" AH: 24.5" WT: 196 lb COM: 8.25 yd WT CAP: 750 lb

ZONE	B/COM	C	D	E	F	G	H	I	J	GENERAL INFORMATION
1	9576	9741	9898	10096	10426	10748	11078	11399	11729	MATERIAL: Maple MOIS. BARR: Included
2	9812	9977	10134	10332	10662	10984	11314	11635	11965	
3	10048	10213	10370	10568	10898	11220	11550	11871	12201	
4	10284	10449	10606	10804	11134	11456	11786	12107	12437	

Specify:

- Product Number
- Wood Finish
- Urethane Color
- Fabric Vendor, Pattern and Color
- Thermoform Finish
- Metal Finish
- Arm Cap Style
- Leg Style
- Sleep Release Button (Left or Right, Color and Location)
- USB/Power Option

See pages 16 & 17 for material and finish options.

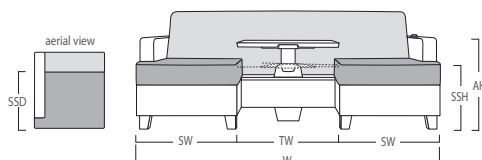

SSH- Sleep surface height 25"
 SSD- Sleep surface depth 30"
 SH- Seat height
 SW- Seat width
 W- Overall width
 Add 4" to overall width for each ottoman specified.

sleepToo® Classic with Table

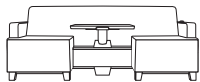

62163T SLEEP SOFA, CLASSIC FRONT, WITH TABLE, 63" SLEEP SURFACE

W: 71" D: 34" H: 33" SW: 22.5" SD: 21.5" SH: 18.5" AH: 24.5" WT: 211 lb COM: 7.75 yd WT CAP: 750 lb

ZONE	B/COM	C	D	E	F	G	H	I	J	GENERAL INFORMATION
1	11955	12110	12257	12443	12753	13056	13366	13668	13978	MATERIAL: Maple MOIS. BARR: Included
2	12251	12406	12553	12739	13049	13352	13662	13964	14274	
3	12547	12702	12849	13035	13345	13648	13958	14260	14570	
4	12842	12997	13144	13330	13640	13943	14253	14555	14865	

Power is not available on 63" model.

62166T SLEEP SOFA, CLASSIC FRONT, WITH TABLE, 66" SLEEP SURFACE

W: 74" D: 34" H: 33" SW: 22.5" SD: 21.5" SH: 18.5" AH: 24.5" WT: 216 lb COM: 7.75 yd WT CAP: 750 lb

ZONE	B/COM	C	D	E	F	G	H	I	J	GENERAL INFORMATION
1	12344	12499	12646	12832	13142	13445	13755	14057	14367	MATERIAL: Maple MOIS. BARR: Included
2	12650	12805	12952	13138	13448	13751	14061	14363	14673	
3	12955	13110	13257	13443	13753	14056	14366	14668	14978	
4	13260	13415	13562	13748	14058	14361	14671	14973	15283	

62169T SLEEP SOFA, CLASSIC FRONT, WITH TABLE, 69" SLEEP SURFACE

W: 77" D: 34" H: 33" SW: 22.5" SD: 21.5" SH: 18.5" AH: 24.5" WT: 221 lb COM: 7.75 yd WT CAP: 750 lb

ZONE	B/COM	C	D	E	F	G	H	I	J	GENERAL INFORMATION
1	12468	12623	12770	12956	13266	13569	13879	14181	14491	MATERIAL: Maple MOIS. BARR: Included
2	12777	12932	13079	13265	13575	13878	14188	14490	14800	
3	13085	13240	13387	13573	13883	14186	14496	14798	15108	
4	13394	13549	13696	13882	14192	14495	14805	15107	15417	

62172T SLEEP SOFA, CLASSIC FRONT, WITH TABLE, 72" SLEEP SURFACE

W: 80" D: 34" H: 33" SW: 22.5" SD: 21.5" SH: 18.5" AH: 24.5" WT: 226 lb COM: 7.75 yd WT CAP: 750 lb

ZONE	B/COM	C	D	E	F	G	H	I	J	GENERAL INFORMATION
1	12598	12753	12900	13086	13396	13699	14009	14311	14621	MATERIAL: Maple MOIS. BARR: Included
2	12910	13065	13212	13398	13708	14011	14321	14623	14933	
3	13222	13377	13524	13710	14020	14323	14633	14935	15245	
4	13534	13689	13836	14022	14332	14635	14945	15247	15557	

62175T SLEEP SOFA, CLASSIC FRONT, WITH TABLE, 75" SLEEP SURFACE

W: 83" D: 34" H: 33" SW: 22.5" SD: 21.5" SH: 18.5" AH: 24.5" WT: 231 lb COM: 7.75 yd WT CAP: 750 lb

ZONE	B/COM	C	D	E	F	G	H	I	J	GENERAL INFORMATION
1	12723	12878	13025	13211	13521	13824	14134	14436	14746	MATERIAL: Maple MOIS. BARR: Included
2	13038	13193	13340	13526	13836	14139	14449	14751	15061	
3	13353	13508	13655	13841	14151	14454	14764	15066	15376	
4	13668	13823	13970	14156	14466	14769	15079	15381	15691	

62178T SLEEP SOFA, CLASSIC FRONT, WITH TABLE, 78" SLEEP SURFACE

W: 86" D: 34" H: 33" SW: 22.5" SD: 21.5" SH: 18.5" AH: 24.5" WT: 236 lb COM: 7.75 yd WT CAP: 750 lb

ZONE	B/COM	C	D	E	F	G	H	I	J	GENERAL INFORMATION
1	12856	13011	13158	13344	13654	13957	14267	14569	14879	MATERIAL: Maple MOIS. BARR: Included
2	13174	13329	13476	13662	13972	14275	14585	14887	15197	
3	13493	13648	13795	13981	14291	14594	14904	15206	15516	
4	13811	13966	14113	14299	14609	14912	15222	15524	15834	

Specify:

- Product Number
- Wood Finish
- Urethane Color
- Fabric Vendor, Pattern and Color
- Thermoform Finish
- Metal Finish
- Arm Cap Style
- Leg Style
- Sleep Release Button (Left or Right, Color and Location)
- USB/Power Option

See pages 16 & 17 for material and finish options.

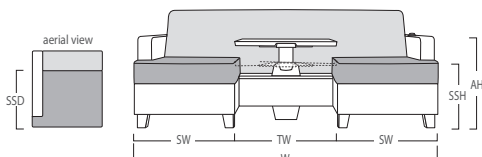

SSH- Sleep surface height 25"
 SSD- Sleep surface depth 30"
 SH- Seat height
 SW- Seat width
 W- Overall width
 Add 4" to overall width for each ottoman specified.

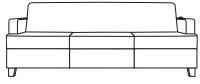

62266 SLEEP SOFA, CUSTOM FRONT, 66" SLEEP SURFACE

W: 74" D: 34" H: 33" SW: 66" SD: 21.5" SH: 18.5" AH: 24.5" WT: 174 lb COM: 9 yd WT CAP: 750 lb

ZONE	B/COM	C	D	E	F	G	H	I	J	GENERAL INFORMATION
1	9105	9285	9456	9672	10032	10383	10743	11094	11454	MATERIAL: Maple MOIS. BARR: Included
2	9329	9509	9680	9896	10256	10607	10967	11318	11678	
3	9553	9733	9904	10120	10480	10831	11191	11542	11902	
4	9777	9957	10128	10344	10704	11055	11415	11766	12126	

62269 SLEEP SOFA, CUSTOM FRONT, 69" SLEEP SURFACE

W: 77" D: 34" H: 33" SW: 69" SD: 21.5" SH: 18.5" AH: 24.5" WT: 180 lb COM: 9 yd WT CAP: 750 lb

ZONE	B/COM	C	D	E	F	G	H	I	J	GENERAL INFORMATION
1	9233	9413	9584	9800	10160	10511	10871	11222	11582	MATERIAL: Maple MOIS. BARR: Included
2	9460	9640	9811	10027	10387	10738	11098	11449	11809	
3	9687	9867	10038	10254	10614	10965	11325	11676	12036	
4	9915	10095	10266	10482	10842	11193	11553	11904	12264	

62272 SLEEP SOFA, CUSTOM FRONT, 72" SLEEP SURFACE

W: 80" D: 34" H: 33" SW: 72" SD: 21.5" SH: 18.5" AH: 24.5" WT: 186 lb COM: 9 yd WT CAP: 750 lb

ZONE	B/COM	C	D	E	F	G	H	I	J	GENERAL INFORMATION
1	9354	9534	9705	9921	10281	10632	10992	11343	11703	MATERIAL: Maple MOIS. BARR: Included
2	9584	9764	9935	10151	10511	10862	11222	11573	11933	
3	9814	9994	10165	10381	10741	11092	11452	11803	12163	
4	10045	10225	10396	10612	10972	11323	11683	12034	12394	

62275 SLEEP SOFA, CUSTOM FRONT, 75" SLEEP SURFACE

W: 83" D: 34" H: 33" SW: 75" SD: 21.5" SH: 18.5" AH: 24.5" WT: 192 lb COM: 9 yd WT CAP: 750 lb

ZONE	B/COM	C	D	E	F	G	H	I	J	GENERAL INFORMATION
1	9478	9658	9829	10045	10405	10756	11116	11467	11827	MATERIAL: Maple MOIS. BARR: Included
2	9711	9891	10062	10278	10638	10989	11349	11700	12060	
3	9945	10125	10296	10512	10872	11223	11583	11934	12294	
4	10178	10358	10529	10745	11105	11456	11816	12167	12527	

62278 SLEEP SOFA, CUSTOM FRONT, 78" SLEEP SURFACE

W: 86" D: 34" H: 33" SW: 78" SD: 21.5" SH: 18.5" AH: 24.5" WT: 198 lb COM: 9 yd WT CAP: 750 lb

ZONE	B/COM	C	D	E	F	G	H	I	J	GENERAL INFORMATION
1	9601	9781	9952	10168	10528	10879	11239	11590	11950	MATERIAL: Maple MOIS. BARR: Included
2	9837	10017	10188	10404	10764	11115	11475	11826	12186	
3	10074	10254	10425	10641	11001	11352	11712	12063	12423	
4	10310	10490	10661	10877	11237	11588	11948	12299	12659	

Specify:

- Product Number
- Wood Finish
- Urethane Color
- Fabric Vendor, Pattern and Color
- Thermoform Finish
- Metal Finish
- Arm Cap Style
- Leg Style
- Sleep Release Button (Left or Right, Color and Location)
- USB/Power Option

See pages 16 & 17 for material and finish options.

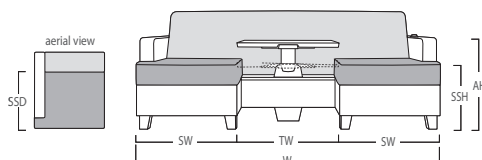

SSH- Sleep surface height 25"
 SSD- Sleep surface depth 30"
 SH- Seat height
 SW- Seat width
 W- Overall width
 Add 4" to overall width for each ottoman specified.

sleepToo® Custom with Table

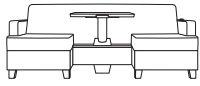

62263T SLEEP SOFA, CUSTOM FRONT, WITH TABLE, 63" SLEEP SURFACE

W: 71" D: 34" H: 33" SW: 22.5" SD: 21.5" SH: 18.5" AH: 24.5" WT: 215 lb COM: 8.5 yd WT CAP: 750 lb

ZONE	B/COM	C	D	E	F	G	H	I	J	GENERAL INFORMATION
1	11967	12137	12299	12503	12843	13174	13514	13846	14186	MATERIAL: Maple MOIS. BARR: Included
2	12263	12433	12595	12799	13139	13470	13810	14142	14482	
3	12559	12729	12891	13095	13435	13766	14106	14438	14778	
4	12854	13024	13186	13390	13730	14061	14401	14733	15073	

Power is not available on 63" model.

62266T SLEEP SOFA, CUSTOM FRONT, WITH TABLE, 66" SLEEP SURFACE

W: 74" D: 34" H: 33" SW: 22.5" SD: 21.5" SH: 18.5" AH: 24.5" WT: 220 lb COM: 8.5 yd WT CAP: 750 lb

ZONE	B/COM	C	D	E	F	G	H	I	J	GENERAL INFORMATION
1	12360	12530	12692	12896	13236	13567	13907	14239	14579	MATERIAL: Maple MOIS. BARR: Included
2	12666	12836	12998	13202	13542	13873	14213	14545	14885	
3	12971	13141	13303	13507	13847	14178	14518	14850	15190	
4	13277	13447	13609	13813	14153	14484	14824	15156	15496	

62269T SLEEP SOFA, CUSTOM FRONT, WITH TABLE, 69" SLEEP SURFACE

W: 77" D: 34" H: 33" SW: 22.5" SD: 21.5" SH: 18.5" AH: 24.5" WT: 225 lb COM: 8.5 yd WT CAP: 750 lb

ZONE	B/COM	C	D	E	F	G	H	I	J	GENERAL INFORMATION
1	12492	12662	12824	13028	13368	13699	14039	14371	14711	MATERIAL: Maple MOIS. BARR: Included
2	12801	12971	13133	13337	13677	14008	14348	14680	15020	
3	13110	13280	13442	13646	13986	14317	14657	14989	15329	
4	13419	13589	13751	13955	14295	14626	14966	15298	15638	

62272T SLEEP SOFA, CUSTOM FRONT, WITH TABLE, 72" SLEEP SURFACE

W: 80" D: 34" H: 33" SW: 22.5" SD: 21.5" SH: 18.5" AH: 24.5" WT: 230 lb COM: 8.5 yd WT CAP: 750 lb

ZONE	B/COM	C	D	E	F	G	H	I	J	GENERAL INFORMATION
1	12616	12786	12948	13152	13492	13823	14163	14495	14835	MATERIAL: Maple MOIS. BARR: Included
2	12928	13098	13260	13464	13804	14135	14475	14807	15147	
3	13240	13410	13572	13776	14116	14447	14787	15119	15459	
4	13552	13722	13884	14088	14428	14759	15099	15431	15771	

62275T SLEEP SOFA, CUSTOM FRONT, WITH TABLE, 75" SLEEP SURFACE

W: 83" D: 34" H: 33" SW: 22.5" SD: 21.5" SH: 18.5" AH: 24.5" WT: 235 lb COM: 8.5 yd WT CAP: 750 lb

ZONE	B/COM	C	D	E	F	G	H	I	J	GENERAL INFORMATION
1	12745	12915	13077	13281	13621	13952	14292	14624	14964	MATERIAL: Maple MOIS. BARR: Included
2	13060	13230	13392	13596	13936	14267	14607	14939	15279	
3	13375	13545	13707	13911	14251	14582	14922	15254	15594	
4	13691	13861	14023	14227	14567	14898	15238	15570	15910	

62278T SLEEP SOFA, CUSTOM FRONT, WITH TABLE, 78" SLEEP SURFACE

W: 86" D: 34" H: 33" SW: 22.5" SD: 21.5" SH: 18.5" AH: 24.5" WT: 240 lb COM: 8.5 yd WT CAP: 750 lb

ZONE	B/COM	C	D	E	F	G	H	I	J	GENERAL INFORMATION
1	12875	13045	13207	13411	13751	14082	14422	14754	15094	MATERIAL: Maple MOIS. BARR: Included
2	13193	13363	13525	13729	14069	14400	14740	15072	15412	
3	13512	13682	13844	14048	14388	14719	15059	15391	15731	
4	13830	14000	14162	14366	14706	15037	15377	15709	16049	

Specify:

- Product Number
- Wood Finish
- Urethane Color
- Fabric Vendor, Pattern and Color
- Thermoform Finish
- Metal Finish
- Arm Cap Style
- Leg Style
- Sleep Release Button (Left or Right, Color and Location)
- USB/Power Option

See pages 16 & 17 for material and finish options.

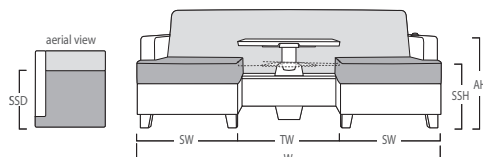

SSH- Sleep surface height 25"
 SSD- Sleep surface depth 30"
 SH- Seat height
 SW- Seat width
 W- Overall width
 Add 4" to overall width for each ottoman specified.