

WIELAND
healthcare

Furniture
Price Book

Volume 143 | Effective January 1, 2024

2024 Price Book Highlights

UPDATES:

- Soul Collection – sofa + mate
- Cove Recliner – back edge wall guard option

ADDITIONAL NOTES:

Minor changes have been made to the Terms & Conditions related to post-pandemic circumstances. The 2024 price increase goes into effect January 1, 2024.

Contents

GENERAL INFORMATION

2024 Price Book Highlights.....	1
Contents	2-3
Terms and Conditions	6-9
Warranty and Renewability	10-11
Ordering Information	14
Options Pricing Information	14
Quick Ship Program	15
Materials & Finishes.....	16
Materials & Finish Options.....	17-18
Order Checklist	19

SEATING & COORDINATING TABLES

Accord™	22-23
Accord™ Recliners	24
Accord™ Sleep Chair.....	25
Allay®	26
Allay® sleep sofas.....	27-28
Allay® Slim sleep sofas	29-30
Amari.....	31
Amari Recliners	32
Amigo Tables	33-35
Canton	36
Canton Arm Chairs	37-38
Canton Tables	39
Canton Modular Tables	40
Capital Gliders.....	41-42
Capital Sleep Chairs	43
Cove	44-45
Cove Patient Chairs	46
Cove Modular Seats	47
Cove Modular Arms.....	48
Cove Lounge	49
Cove Recliners	50
Cove Patient Recliners	51
Cove Orthopedic Recliners	52
Cove Sleep Recliners.....	53
Cove Orthopedic/Sleep Recliners.....	54
Cove Trendelenburg Recliners.....	55
Dune	56
Dune Occasional Tables	57-58
Hale.....	59
Hale Arm Chairs.....	60-61
Hale Benches	62
Hale Patient Chairs	63
Hale Motion Chairs.....	64
Hale Easy Access Chairs	65
Hale Modular Tables	66
Latitude	67
Latitude Chairs.....	68-69
Latitude Benches	69
Laurelwood	70

Laurelwood Patient & Motion.....	71
Laurelwood Bariatric	72
Laurelwood Bariatric Mid Back.....	73
Link	74-75
Monroe.....	76-78
Monroe Freestanding Tables.....	79
Monroe Modular Tables.....	80
Perk.....	81
PlyFold	82-83
PlyLok Upholstered Seat	84
PlyLok Wood Seat	85
PlyLok Bar Stools, Counter Stools	86
PlyLok Back Styles and Accessories	87
Pose Stools	88
Rally	89
Rally Aspire.....	90
Rally Embrace.....	91
Rally Indulge.....	92
Rally Compose.....	93
Rally Compose with Embrace	94
Rally Armless Universal.....	95
Rally Ottomans & Tables.....	96-97
sleepToo®	98-99
sleepToo® Classic.....	100
sleepToo® Classic with Table	101
sleepToo® Custom.....	102
sleepToo® Custom with Table	103
Soul.....	104
Soul Mate	105
Soul Sofa	105
Sprout.....	106
Trace	107
Trace Metal Waiting & Motion	108
Trace Wood Waiting.....	109
Trace Metal Patient & Motion.....	110
Trace Wood Patient	111
Trace Easy Access Chairs.....	112
Trace Tables.....	113
Upland	114
Upland Poly Seat/Plastic Back.....	115
Upland Poly Seat/Plastic Back.....	116
Upland Poly Seat/Uph Back	117
Upland Poly Seat/Uph Back	118
Upland Uph Seat/Plastic Back	119
Upland Uph Seat/Plastic Back	120
Upland Uph Seat/Uph Back.....	121
Upland Uph Seat/Uph Back.....	122
Upland Easy Access Poly Seat.....	123
Upland Easy Access Uph Seat	124
Upland Poly Seat/Plastic Back Bar Stools	125
Upland Poly Seat/Uph Back Bar Stools.....	126

Contents

Upland Uph Seat/Plastic Back Bar Stools	127
Upland Uph Seat/Uph Back Bar Stools	128
Upland Tables.....	129
Versant Glider	130-133
Versant Sleep Chairs	134-135
Wedgewood	136-137
Wedgewood Bariatric	138-139

TABLES

4700 Series Occasional Tables	142
Drum & Cube Occasional Tables	143
Fuse Occasional Tables.....	144
Trumpet & Disc Occasional Tables.....	145
Fuse Multi-purpose Tables	146
Trumpet & Disc Multi-purpose Tables	147
Tubular Multi-purpose Tables	148-150
Tubular Tables Accessories	151

TASK CHAIRS

Delta.....	154-157
Trey®-G.....	158

CHAPEL FURNITURE

Vantage	161
Vantage SE	162
Vantage Accessories	163
Oaklok	164
Oaklok Accessories	165-166
Unity®.....	167-169
Unity® Accessories.....	170-171
Chancel	172-174
Additional Chapel Product Accessories.....	175-176

Terms and Conditions
Warranty

Terms and Conditions

CONTACT INFORMATION

Please contact Wieland with questions or for assistance.

Wieland
10785 Rose Avenue
New Haven, IN 46774-9246
Phone 888.943.5263 | Fax 260.627.6496
wielandhealthcare.com | sales@wielandhealthcare.com

Wieland is a brand of Sauder® Manufacturing Co.

DEFINITIONS

Company means Sauder® Manufacturing Co., its servants, employees, and agents and includes Sauder® Manufacturing Co; Sauder Worship Seating®; Sauder Education®; Sauder® Courtroom Furniture; Wieland; Butler Human Services®, Sauder Courtroom Seating®; and any affiliated, predecessor or successor entities.

GENERAL TERMS

EXCLUSIVE CONTRACT TERMS

These Terms and Conditions shall be deemed incorporated as a part of every contract to purchase goods from the Company. By entering into a purchase contract with the Company and accepting delivery of the goods, Purchaser agrees that these Terms and Conditions are the sole and exclusive statement of all such terms and conditions, that the contract is limited to these terms and conditions, and that any different or additional terms and conditions proposed by Purchaser are objected to and shall not become a part of the contract unless expressly accepted by Company in writing.

AUTHORIZED DEALERS

Possession of these terms and conditions, product information and/or price list does not imply the right to purchase products illustrated and priced therein. Sales are confined to accounts with credit approval only. A minimum of 30 percent down payment is required on all orders until credit is established.

APPLICABLE LAW

The Contract shall be governed by the substantive laws of the State of Ohio. The sole and exclusive jurisdiction and venue for the enforcement or any rights or obligations relating to the contract or the goods shall be in the Fulton County, Ohio Court of Common Pleas or the United States District Court for the Northern District of Ohio, and the parties consent to the jurisdiction of these courts as a part of this transaction. The Company shall be entitled to recover its reasonable attorney's fees, costs and expenses in connection with any action taken by Company to enforce the contract (including these Terms and Conditions).

GOVERNMENT REGULATIONS

Customer shall comply with all applicable governmental laws, codes and regulations, including building and fire codes applicable to this purchase and including design, type of material and installation arrangements thereof.

PRICES & PAYMENT TERMS

PRICES

Published prices are list, FOB destination, per zone destination. Prices do not account for special delivery situations including the following, which are the responsibility of the Purchaser:

- Dedicated delivery appointments
- Lift gate
- Multiple drops on site per shipment

- Multiple shipments per order (that could be accommodated by one delivery)
- Charges for cartons, packaging, and crating, beyond the normal Company shipping methods
- Storage or insurance claims
- Sales and other taxes
- Local delivery, uncrating, and installation (if applicable)

Prices on Order Acknowledgements are net. Company reserves the right to change prices prior to Order Acknowledgement without notice. Company reserves the right to increase prices or any part thereof, if Purchaser delays delivery of the furniture beyond 8 weeks from receipt of any of the following: Order Acknowledgment, signed order contract, receipt of subcontract, and/or receipt of signed purchase order.

In addition to any other right of Company to increase prices as set forth herein, in the event Purchaser, for any reason, directs delivery of goods and services ordered to occur beyond 8 weeks from receipt of any of the following: Order Acknowledgment, signed order contract, receipt of subcontract, and/or receipt of signed purchase order, Purchaser shall bear the risk of and be responsible to pay Company any price increases that may occur in connection with the goods and services ordered as well as storage costs arising from or incurred as a result of same. Company reserves the right to require a non-refundable deposit be paid by Purchaser to Company in the event of the foregoing.

PERFORMANCE BONDS

If a bond is required, the cost shall be 1% of the total Contract. If a bond is not specifically listed on the Contract it is not included. If a bond is purchased, the bond will only cover substantial completion of the project plus one year of the warranty period.

TAXES

All sales are subject to sales tax unless a valid sales tax exemption certificate or resale certificate for the ship-to state accompanies the order.

INVOICING

Product will be invoiced at the time of shipment, or as designated by the Order Acknowledgment. If a partial order is shipped and a back order is created, Purchaser will be invoiced for the portion that shipped.

TERMS OF PAYMENT, SECURITY INTEREST AND LIEN RIGHTS

Credit will be established based upon Company's determination of credit worthiness. A deposit or prepayment may be required on certain accounts after credit review. Credit terms are 30 days net from date of invoice and/or as designated by the Order Acknowledgment. Company may cancel or change credit terms at its discretion and may request advance payment at any time. No order will be released for production without a credit approval from the Credit Department. Company may at its option, and without notice, raise or allow charges in excess of any credit limit granted. Purchaser understands and agrees that (the Purchaser) is responsible for all charges on the account. All payments due to Company shall be paid without any set-off or claim.

Purchaser agrees to pay a service charge of 1.5 percent per month or as allowed by law on all past due accounts. A past due account is an account that remains unpaid for more than 30 days. Until such time that an account and/or an order is paid in full to the Company, Company shall retain a security interest in and lien on all materials, merchandise, furnishings, and/or goods manufactured, provided, delivered or otherwise on said account and/or order. Company reserves and may exercise any and all rights and remedies

Initials _____ Date _____

Terms and Conditions

with respect to said materials, merchandise, furnishings, and/or goods against the Customer and/or any individual or entity in possession of or claiming an interest in said materials, merchandise, furnishings and/or goods, including but not limited to demanding assembly of the goods at the direction of Company, re-taking possession and selling and applying proceeds of any sale toward the account, and/or filing suit. All charges are payable according to these terms and conditions unless otherwise prearranged and agreed to in writing by Company.

TITLE & RISK

Title to all goods shall pass from Company to Purchaser upon Company's receipt of payment in full under this Contract or any change thereof. Risk of loss or damage to the goods becomes the responsibility of Purchaser upon delivery. Unless otherwise specified in writing, Company will determine the method of shipment and carrier. If products are shipped via Purchaser's choice of carrier, Company is not responsible for damage in shipment.

Purchaser will insure the goods against all insurable risks in the name of Purchaser and also in the name of Sauder Manufacturing Co. as the unpaid vendor for their full insurable value.

ORDERING & LEAD TIME

ORDERING

A signed purchase order or contract received via mail, fax or email is required before an order is processed. In addition, credit applications, credit references and/or advance payments may be required for newly established accounts. Orders are not scheduled in production, nor materials purchased, until all details are received.

ORDER ACKNOWLEDGMENT

Orders are binding upon receipt of the Order Acknowledgement. The Order Acknowledgement, which relates to the acceptance of the order/contract, is sent after the order/contract contemplates pricing changes, if any, delivery dates and/or estimated installation completion. Any and all modifications to the Order Acknowledgement must be reconfirmed and signed by Company.

Acceptance of the Order Acknowledgement shall be evidenced by signature(s) and/or Company commencing work on the project.

Any error or discrepancy on the Order Acknowledgement must be reported to Company in writing with 3 working days from the receipt of the Order Acknowledgement. Cashing a down payment check does not constitute acceptance.

CHANGE ORDERS

The order as shown on the Order Acknowledgement can be modified only by a written communication or reconfirmation signed by Company and Purchaser.

Company may, at its discretion, accept reasonable change orders with the following conditions:

- The request for change must be submitted in writing and received before order specific parts have been purchased and/or the manufacturing process has begun.
- Changes may be subject to additional charges for material, labor, restocking, and administrative costs.
- Changes may result in an extended delivery date.

CANCELLATIONS

Any deposit made with respect to the order is non-refundable. Company reserves the right to cancel any order, with notice to Purchaser, due to breach of obligation or contract. Additionally, if an order is cancelled after order specific materials have been purchased and/or production has started,

Purchaser will be responsible for the cost associated with those materials or production. Any Customer's Own Material (COM) supplied will be returned "as-is". This applies to any fabric that has been cut, wood parts with a finish applied, and all laminates. A cancellation or restocking charge of 1/3 of the net sale is applicable on orders cancelled.

LEAD TIME

Lead times will vary based on specifications chosen and available manufacturing capacity. Consult your authorized sales representative or the home office when placing your order to determine estimated ship date.

DRAWINGS

The drawing(s) are a key component in determining final quantities and layouts for goods requiring installation. The Final Signed Drawing shall be considered a legal and binding part of the Contract. Changes to the Final Signed Drawing can only be made through written communication to Company or reconfirmation signed by Company and Purchaser. Changes requested may incur additional costs and/or delivery delays.

CUSTOM PRODUCTS AND MATERIALS

All nonstandard designs and materials are subject to a surcharge; contact Company for approval and pricing. The use of nonstandard designs and/or materials may cause extended delivery times and reduced warranty coverage.

- Within our standard offering, an upcharge may be applied if a premium pattern or finish is selected. This may also cause extended lead times.

CUSTOMER'S OWN MATERIAL (COM)

Please contact Company on all COM fabrics. A sample of the COM fabric is required to be submitted to Company for approval and yardage estimate prior to placing an order. The sample should be large enough to indicate a repeat if applicable.

Yardage requirements will be calculated based on a variety of factors including roll width, pattern matching and direction. If a fabric is directional, it will be applied vertically unless specific instructions are given to the contrary. If a horizontal application is desired, please inform Company as additional yardage or special production techniques may be required. At Purchaser's request, Company may, in its discretion, for non-Company program fabrics handle the purchase of the COM fabric for a charge of 20 percent of the fabric list price.

Company reserves the right of preliminary approval for all COM prior to order acceptance. Even after such preliminary approval, Company reserves the right to reject COM if, upon physical inspection of the material, it proves unacceptable for use on Company products. When COM is accepted, Company assumes no responsibility for appearance, durability, color fastness, or any other quality after it is upholstered on a Company product.

Orders with COM are not scheduled into production until all materials are received and inspected. *Refer to the checklist to ensure the proper handling of COM fabrics.* If partial shipment entry is required, indicate on purchase order, or forward orders with standard products and COM products on separate purchase orders. Shipping address:

Sauder Manufacturing Co.
C/O Wieland
10785 Rose Avenue
New Haven, IN 46774-9246

Initials _____ Date _____

Terms and Conditions

PRODUCT DESIGN, COMPLIANCE & SAFETY

PRODUCT DESIGN

Company reserves the right to make changes in design and construction or to discontinue products without prior notice.

COMPLIANCE

Products offered by Company do comply with the requirements of local, state and national fire codes. The products offered as a base are manufactured with resilient filling materials and textiles in compliance with California Technical Bulletin TB117-2013.

THE TOXIC SUBSTANCES CONTROL ACT

Enforced by the EPS, TSCA a law enacted in 1976 regulates chemical substances and mixtures in commerce. Products offered comply with all applicable rules or orders under the TSCA, and no chemical substances in violation of the TSCA are offered.

GREENGUARD® CERTIFICATION

Company has achieved Greenguard certification on all products and Greenguard Gold on many. Please reference Wielandhealthcare.com for product specific information. GREENGUARD certified products are certified to meet GREENGUARD standards for low chemical emissions into indoor air during product usage. For more information, visit <https://spot.ulprospector.com/en/na/Builtenvironment> or contact Company for a complete list of all our certified products.



BIFMA

Sauder Manufacturing Co. is proud to demonstrate a commitment to the environment, and to both the quality and performance of products through BIFMA e3 LEVEL testing and certification. Learn more about BIFMA Certification at levelcertified.org.

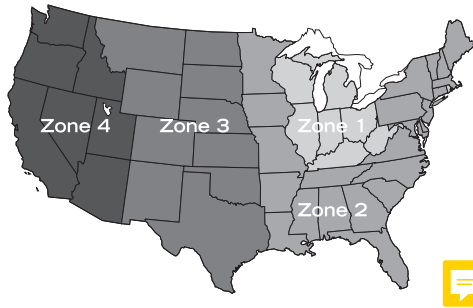

FREIGHT & DELIVERY

FREIGHT

Unless otherwise arranged in writing, all Company shipments are made on a site-to-site basis (back of trailer). Unless otherwise specified in writing, we will determine the method of shipment and carrier. All weights and dimensions provided in product literature are approximate. See map below for zone identification within the continental United States. [Contact your

	0-10 lbs	11-20 lbs	21-50 lbs	51-100 lbs	101-199 lbs
ZONE 1	\$50	\$70	\$80	\$100	\$130
ZONE 2	\$55	\$80	\$90	\$120	\$140
ZONE 3	\$60	\$90	\$100	\$135	\$160
ZONE 4	\$70	\$100	\$115	\$150	\$200

Shipping and handling prices are net.

authorized sales representative for pricing in Alaska, Hawaii and outside the United States.]

MINIMUM SHIPPING AND HANDLING CHARGE

Orders that weigh less than 200 lb. will require an additional shipping and handling charge. See the chart to determine the net charge based on total order weight.

BUILDING ACCESS

Facilities must be ready to receive furniture. All construction must be complete before we can start delivery and installation. There must be free and clear easy access to the building where the furniture will be installed. Rooms, hallways, lobby, and entrance way must be empty and free and clear of all obstructions. All buildings with 3 or more floors must have working elevators free and clear of all obstructions and dedicated for the sole use of our installers during our installation. If upon arrival for delivery and installation, the conditions described in this paragraph are not met, the installation will not be started.

DELAYED DELIVERY

Company reserves the right to increase prices or any part thereof, if Purchaser delays delivery of the furniture beyond 8 weeks from receipt of any of the following: Order Acknowledgment, signed order contract, receipt of subcontract, and/or receipt of signed purchase order. Purchaser agrees not to use the Goods described on the order until the full purchase price is paid to the Company.

In addition to any other right of Company to increase prices as set forth herein, in the event Purchaser, for any reason, directs delivery of goods and services ordered to occur beyond 8 weeks from receipt of any of the following: Order Acknowledgment, signed order contract, receipt of subcontract, and/or receipt of signed purchase order, Purchaser shall bear the risk of and be responsible to pay Company any price increases that may occur in connection with the goods and services ordered as well as storage costs arising from or incurred as a result of same. Company reserves the right to require a non-refundable deposit be paid by Purchaser to Company in the event of the foregoing.

DELIVERY

Company shall not be liable for delays in delivery of furniture caused by fire, strikes, weather or from causes beyond its control.

SPECIAL DELIVERY CHARGES

Request to Carton	\$20 per unit
Delivery Appointment	\$400
Inside Delivery	\$150 plus \$50/unit
Lift Gate Required	\$2,500
Multiple Stops	\$250 per stop
Box Truck Required*	\$1200

*Required if 53' semi truck is too large to access dock.

Above prices are net.

An on-site delivery date will be established once all details needed for production and installation (if applicable) have been received. Delivery of Goods may be separate from commencement of installation.

The delivery price submitted is based on the understanding that there shall be appropriate access to the site free of any hindrance whatsoever, timely access to the site and adequate space to unload the Goods. In the event that the site is not fully ready as described previously at the time of delivery,

Initials _____ Date _____

Terms and Conditions

[Company reserves the right to charge and collect additional fees to cover any additional costs incurred. These charges include but not limited to the following: delivery appointment, consolidation of shipment, lift gate, multiple stops, special packaging, dedicated truck, expedited shipment, greater than two hour unload time, box truck required, residential shipment.]

The goods may arrive in cardboard boxes. Unless otherwise specified, it is the Purchaser's responsibility to arrange for the disposal of the boxes.

STORAGE FEES

If Goods are ready for shipment according to the terms of the Order Acknowledgment or subsequent change order, and Customer cannot receive as stated, the Goods may, at our discretion, be shipped to storage facilities, or put in storage at Purchaser's expense. Company reserves the right to deny storage of the Goods due to lack of available space. Storage fees are 5% of purchase price per month. These charges can, at Company's option, be added to the order total amount due or invoiced separately. Storage fees are considered change orders. See CHANGE ORDER SECTION requirements. All storage fees are required to be paid in full before ship. All risk of damage, destruction, theft or loss while in storage shall be the responsibility of Purchaser.

INSTALLATION

Purchaser accepts responsibility for the safety of all persons except Company representatives on the premises where Company performs delivery and/or installation and, accordingly, Purchaser shall also defend and save Company harmless from all claims from persons injured on the premises where delivery and/or installation is performed.

The installation contract price is based upon full building and location access and readiness for installation to begin upon on-site delivery. The space must be climate controlled, not affect by outside weather conditions, permanent utilities must be operational and carpet and/or any flooring must be complete. In addition, any of the other contractors must not interfere with the unloading, staging or installation process including any overhead electrical, lighting or painting projects or any other work that would interfere with the placement of the furniture into its permanent locations. Failure to have the site ready for installation may result in additional cost to the Purchaser not previously shown on the contract. These additional costs may include, but are not limited to, additional handling charges, insurance, down-time (which includes additional labor, lodging and meals), and/or any other proper expense incurred by the Company. If site conditions cause a substantial delay, the installer may leave the job site, installation will be rescheduled and Purchaser will be responsible for the return fee for the installation crew.

RETURNS & CLAIMS

RETURNS

No merchandise may be returned to Company without prior written consent from Company, and any returns must be in accordance Company's shipping instructions. If approved, returns for reasons other than valid warranty claims will be subject to shipping and handling charges, and must be made, FOB the Company. In addition, restoration and restocking charges may be charged to Purchaser.

DAMAGE CLAIMS

Freight terms are F.O.B. destination. Risk of loss, damage or destruction from and after delivery is the responsibility of Purchaser, it being agreed and understood that loss, damage or destruction of goods from and after delivery does not relieve Purchaser of its payment obligations to Company.

Purchaser is advised to inspect the shipment and note any damage on the bill of lading. Notification of damage discovered after delivery must be given to Company within 10 days immediately following delivery.

When products are shipped via Purchaser's choice of carrier, Company is not responsible for damage in shipment. Purchaser should carefully inspect all items at time of delivery and note any obvious damage on the delivery receipt. For Purchaser's protection, such obvious or subsequently discovered concealed damage must be reported in writing to the carrier in accordance with applicable regulations and time limits. Company does not assume any responsibility for damage that occurs during storage.

OTHER CLAIMS

All claims against Company other than valid warranty claims, including claims for shortages and errors, must be made in writing within 10 days after delivery. The facts on which the claim is based must be directed in writing to the Warranty Service Coordinator. Failure to make any such claim against terms and conditions to Company within such 10-day period shall constitute acceptance of the merchandise and waiver of any such shortages, errors, or other claims of any type or nature. The cost of field repairs or adjustments performed by any non-Company personnel will not be reimbursed unless previously authorized in writing by Company.

CONSEQUENTIAL LOSS

Under no circumstances shall Company be liable to any party hereto or any third-party for any special, indirect, punitive, incidental or consequential damages or loss (including lost profits, loss of use, damage to goodwill or loss of business) in connection with or in any way related to the agreement between the parties.

FORCE MAJEURE AND OTHER MATTERS BEYOND COMPANY'S CONTROL

Company is not liable for failure to perform or delay in performance or delivery due to cancellation or postponement or deemed in breach of the Agreement (or PO if using Purchase Order) based on circumstances resulting from any cause beyond either parties control including, but not limited to, federal or state governmental orders or lack thereof, legislation, regulations, labor strikes, accidents, epidemic, pandemic, immediate threat of mass casualties or contagious illness or disease, act of war, riot, mass shooting, terrorism, acts of God, fires, severe weather conditions, floods, curtailment of transportation and or supply chain, inability to secure materials, electrical failure or any event that prohibits attendees being able to attend the event. Parties agree to minimize the damage of the Force Majeure Event to fullest extent possible. Notices shall state the nature of the Force Majeure Event, actions the party wishes to take, and if applicable a plan to mitigate any delays caused by the event. Such notice shall not subject either party to any penalties, liquidated damages, or forfeiture of any pre or post payment. Company reserves the right to modify order pricing and/or product offerings at any time based on material cost increases, supplier cost increases, economic fluctuations, supply chain issues and/or other issues related to the foregoing. All orders may be subject to an increase in prices or any part thereof, and such other charges as set forth herein if Purchaser delays delivery of the furniture beyond 8 weeks from receipt of any of the following: Order Acknowledgment, signed order contract, receipt of subcontract, and/or receipt of signed purchase order.

Signature _____ Title _____ Date _____

Warranty and Renewability

All products are warranted to the original purchaser against factory defects in workmanship and materials which first arise and are reported to the company within the applicable warranty periods. This warranty information covers the structure of the furniture: the laminated-veneer or solid wood frame, the construction of the arms, table legs and stretchers, delamination of tables, and all fasteners and moving parts.

Years under Warranty – Structure							renewability	
Seating	1	2	3	5	10	25	full	component
Accord™						X	X	
Allay®						X	X	
Amari						X	X	
Canton						X		X
Capital						X	X	
Chancel						X		X
Cove						X	X	
Delta					X			X
Hale					X			X
Latitude					X		X	
Laurelwood					X			X
Link					X			X
Monroe					X			X
Oaklok					X			X
Perk					X			X
Plyfold					X			X
Plylok					X			X
Pose					X			X
Rally					X		X	
sleepToo®					X		X	
Soul					X			X
Sprout					X			X
Trace					X			X
Trey®-G					X			X
Unity					X			X
Upland					X			X
Vantage					X			X
Versant					X		X	
Wedgewood					X			X
Years under Warranty – Structure							renewability	
Tables	1	2	3	5	10	25	full	component
4700 Series						X		X
Amigo						X		X
Canton						X		
Cube						X		
Disc						X		X
Drum						X		
Dune					X			
Fuse					X			
Trumpet					X			X
Tubular					X			X

Years under Warranty – Structure						
Accessory	1	2	3	5	10	25
Accord™ intelliTrac™					X	
Accord™ Recline Mech					X	
Accord™ safeBrake					X	
Accord™ Sleep Chair Mech					X	
Accord™ Transfer Arm					X	
Allay® Ottoman Mech					X	
Allay® Drawer Slides		X				
Amari Brakes			X			
Amari Recliner Mech					X	
Amari Transfer Arm					X	
Capital Sleep Chair Mech					X	
Cove Brakes			X			
Cove Recliner Mech					X	
Cove Transfer Arm					X	
Glider Mech					X	
SmartRail					X	
Power Unit - 120V/USB	X					
Pneumatic Cylinder				X		
sleepToo® Drawer Slides		X				
sleepToo® Ottoman Mech					X	
sleepToo® Nylon Back Fabric				X		
sleepToo® Table and Table Mech					X	
Tablet Arms, Casters and Brakes			X			

Fabric:

The Company warrants Wieland Program Fabrics, if purchased through Wieland for use on Wieland products for a period of 5 years.

Company has assembled an extensive graded-in offering featuring a wide selection of upholstery selected for performance. Wieland Program fabrics are available through ArcCom, Architex, Maharam, Mayer, Momentum, and Stinson. Company warrants these textiles to perform under normal conditions as furniture upholstery and when cared for according to cleaning and maintenance guidelines provided by the textile supplier. Proper care and cleaning is imperative for maximizing textile performance. However, in the unlikely event that one of these upholsteries does not perform in accordance with manufacturing specifications when used and maintained under normal conditions, and the user has not misused, cleaned or attempted to clean using cleaning agents or procedures not suggested or approved by the textile supplier, Company will replace the fabric free of charge.

Exclusions:

The following are specially excluded from the warranty:

1. Any custom components that are not a part of the company standard line. This would include, but not be limited to, custom-designed parts or customer specified components, such as fabric, vinyl, foam, etc., that are not a part of the standard company product line.
2. Furniture that has been unduly exposed to elements such as water, light radiation, etc.
3. Damage caused in storing/moving products or furniture after delivery and prior to installation – when stored at customer request.

continued on next page

Warranty and Renewability

4. Damage caused by on-site construction process, other contractors or subcontractors, or the work of such contractors or subcontractors, including drywall dust.
5. Damage as the result of accident, fire, flood, civil disorder, strike, Acts of God, abuse, misuse or any cause outside of ordinary usage.
6. Normal wear and tear, maintenance, scratching or natural wearing of finishes on chairs and tables.
7. Any responsibility for the effects the chairs have on flooring.
8. Damage caused from shipping.

General Information:

- A. We have agreements with our upholstery suppliers to assure that all products meet Association of Contract Textiles standards for bow and skew. We also further eliminate pattern variability in our cutting process. However, you may still notice some irregularities that are within industry standards and are not covered under our product warranty.
- B. Replacement, repair, or refund of the purchase price, (pro-rated for use), as determined by Company and is the "sole and exclusive" remedy under the warranty, and all incidental and consequential damages are excluded and disclaimed from warranty coverage.
- C. To receive benefits under the terms of this warranty, the purchaser must:
 1. Notify Company of the defect.
 2. Fill out Company service request form, which will be sent to you, and provide a description of the defect.
 3. Submit completed form along with applicable photos.
- D. Any disputes over the provisions of this warranty will be mutually reviewed by representatives of Purchaser and Company.

E. ALL IMPLIED WARRANTIES, INCLUDING ANY WARRANTIES OF MERCHANTABILITY OR FITNESS FOR A PARTICULAR PURPOSE ARE EXCLUDED AND DISCLAIMED. THIS LIMITED WARRANTY IS THE ONLY WARRANTY FROM COMPANY APPLICABLE TO THE GOODS.

TYPES OF RENEWABILITY

Fully Renewable: These products have replaceable covers with hook and loop upholstery attachment and most components are replaceable as well

Component Replaceable: Entire seat cushions (wood/foam/upholstery) and back cushions (wood/foam/upholstery) are replaceable. Additional replaceable components may vary per product. Additional component examples: Arms, tops, foot or casters, arm or back caps, handles, drawers or doors, etc.

See Chart for product details.

Ordering Information

Ordering Information

DIMENSIONS AND WEIGHTS

The dimensions and weights used throughout all of Company materials are approximate. The Price Book contains the most accurate information. If you are working on a specification which calls for close tolerances, please call the home office for the precise measurements.

FABRIC ZONES

Fabric zoning (using different fabrics for seat, back, etc.) is available without an additional charge. When multiple fabric grades are selected, unit price is based on the highest fabric grade selected. Zoning worksheets must be submitted for lounge products.

FABRIC GRADES

Fabric pricing for patterns greater than J are available from your representative by quote.

STACK CHAIRS

Many of the products are stacking. Please refer to the notes for details or contact customer service for additional information.

CUSTOM HEIGHT CHAIRS

Chairs: Available on any 4-leg chair and ottoman. Not available on sledbase chairs. Maximum cut-off is 2 inches.

LEFT VS. RIGHT SPECIFICATIONS

Specify left- or right- when facing the front of the chair, unless otherwise specified.

LASER CUT AND LASER CUT WITH COLOR FILL

The Company offers a unique and distinctive way to personalize and identify a facility's chairs with a laser cut of its logo or seal on the back and/or front of any all-wood chair or back of a wood back chair with upholstered front. Simply provide your company sales representative with the desired location, a digital file (TIF, GIF or JPG) and the finish size (standard sizes are 2.5" x 4.5" or 4.25" diameter; non-standard sizes are available at an additional charge).

Options Pricing Information





ADDITIONAL OPTIONS PRICING

Specify any of this at the time of ordering.



\$952 per order Custom Finish Match
 \$37 per chair Custom Chair Heights

*Only on select products, contact your rep for additional information.
 See details in Ordering Information*

GLIDES Available for LAURELWOOD, PLYFOLD, PLYLOK, VANTAGE, UNITY®, OAKLOK and WEDGEWOOD

\$11	7144000 Plastitack Glides	Set of four replacement glides	
\$11	7144012 Chrome Rubber Cushioned Glides	Set of four replacement glides	
\$11	7144013 Non-skid Rubber Cushioned Plastitack Glides	Set of four replacement glides	
\$11	7144022 Accessories Plastic Caps for 4012 Glides	Set of four replacement glides	

INTERLOCKS Available for OAKLOK, PLYLOK, UNITY® and VANTAGE

\$8	7074129 Straight Metal Interlock	Female mounted on right leg. Male mounted on left leg.	
\$43	7074130 Radius Metal Interlock	Female mounted on right leg. Male mounted on left leg.	

Quick Ship Program

INFORMATION AND PRODUCT AVAILABILITY

Choose from the following models, standard finishes and selected fabrics:

AVAILABLE MODELS

- Laurelwood (does not include urethane options)
- Link
- Oaklok
- Perk
- PlyFold
- PlyLok
- Trace Wood (does not include urethane or thermoform options)
- Vantage
- Wedgewood (does not include urethane options)

QUICK SHIP TERMS AND CONDITIONS

1. A written, faxed or e-mailed purchase order must be received by Company before the order will be released for production.
2. Cancellations and change orders cannot be permitted after receipt of written, faxed or e-mailed purchase order.
3. Contact your rep for current quick ship lead times.

Lead times on the Program may be extended at peak production times during the year, due to production schedules being at maximum capacity.
4. If Company program upholstery is back-ordered or COM upholstery is specified, your order will be produced 20 WORKING DAYS after receipt of upholstery requirements.
5. Maximum quantity for the Program is 25 chairs. Larger quantities require the standard lead-time.

Materials & Finishes

GENERAL INFORMATION

The Company furniture incorporates a variety of materials and finishes in our product offering. Not all materials and finishes are available on all products. The following pages provide information on the availability of standard materials and finishes, as well as custom options that are available. Fabric information is not included in this section.

Due to natural variations beyond Company's control, all materials including but not limited to fabric, wood or steel are sold subject to variations or irregularities of color, grain and texture. Because of these variations, Company's samples may not exactly match that of the finished product.

NONSTANDARD MATERIALS

All nonstandard materials are subject to a surcharge. Contact the home office for approval and pricing. The use of nonstandard materials may cause extended delivery times and reduced warranty coverage.

CUSTOM WOOD FINISHES

Contact the home office for finish match availability by product. Customer provides a sample for the color match and must approve the custom finish match before the order can be scheduled for production.

It is recommended that furniture being ordered for placement near existing products have a custom finish match. Color variances may occur between orders without a custom finish match. Custom finish matches for any standard company finish are available at no additional charge.

WOOD FINISHES

Prices listed are based on the standard company wood finishes listed below. Wood finish names describe the color only, not the wood species. Stains are applied to the specific product's standard wood type such as maple, beech, oak. The standard species of each product is listed next to the product throughout the pricing pages. Not all finish colors are available on all products. Some finishes will require a minimum quantity when ordered on certain casegood products.

Natural 73	Amber 74	Honey 75
Nutmeg 76	Henna 77	Urban Cherry 78
Mahogany 79	Sepia 80	Walnut 81
Molasses 82	Black 83	Driftwood 409

POLY AND PLASTIC FINISHES

Poly and plastic components are available for Upland seating. See the materials & finish options chart for availability.

Black	Light Grey
Sterling Grey	White

METAL POWDER COAT COLORS

Silver and black (available on all metal products)

SPECIALTY POWDER COAT COLORS

Accord™: Silver, Black, Sable, and Dove

sleepToo®: Silver, Black, Bronze and Gunmetal

Canton, Upland, Pose, Delta, Amigo, Dune, Sprout, Fuse, Tubular,

Trumpet and Disc: Silver, Black, Nickel, Soft White, Deep Taupe, Umber and Gray

THERMOFORM FINISHES

Thermoform surfaces are available for some products. Cost may vary based on color, please call for information. Standard Thermoform colors available are:

Beige	Palos Mahogany	Hardrock Maple
Finesse	Shaker Cherry	Dark Grey
Honey Alder	Pepperdust	Verismo
Brushed Aluminum	Chocolate	Iona Gray
Monterey	Solara Oak	Calcutta Black
Clove		

WOOD FINISH THERMOFORM COORDINATES

WOOD FINISH	THERMOFORM MAPLE WOOD	THERMOFORM OAK WOOD
Natural 73	Hardrock Maple	NO MATCH
Amber 74	Honey Alder	Honey Alder
Honey 75	Solara Oak	Solara Oak
Nutmeg 76	Shaker Cherry	Shaker Cherry
Henna 77	NO MATCH	NO MATCH
Urban Cherry 78	Shaker Cherry	Shaker Cherry
Mahogany 79	Clove	Clove
Sepia 80	Palos Mahogany	Palos Mahogany
Driftwood 409	Iona Gray	Iona Gray
Walnut 81	Finesse	Finesse
Molasses 82	Verismo	Verismo
Black 83	Calcutta Black	Calcutta Black

Thermoform will never match a natural wood finish. Selections above are close coordinates to Company wood finishes.

LAMINATE OPTIONS

Laminate options vary by product line. Individual table tops are available with standard laminates from Formica™, Nevamar™, Pionite™, and WilsonArt™. See the Laminates Thermoform Coordinates chart for additional laminate information. In-stock Wilsonart colors listed below are available on some products and specifying them will improve lead times and coordinate with matching 2MM PVC Wood Grain edges.

Designer White	Black	Dove Grey	Carbon Mesh
Shadow	Antique White	Fusion Maple	New Age Oak
Wild Cherry	Walnut Heights	Empire Mahogany	River Cherry
Cafelle	Studio Teak	Asian Night	

Specifying the above laminates on the following products will improve lead times:

Amigo	Canton	Dune
Monroe	Sprout	Fuse
Upland	Drum/Cube	Trumpet
Disc	Tubular	

Materials & Finish Options

NONSTANDARD AND CUSTOM LAMINATES

Nonstandard and custom/logo laminates are also available on select products for an additional upcharge. Please contact the Home Office for information on ordering nonstandard and custom/logo laminates.

COORDINATING LAMINATES

COMPANY FINISH	BEECH WOOD SPECIES	MAPLE WOOD SPECIES	OAK WOOD SPECIES
Natural (73)	F: Amber Maple 7012-58	W: Fusion Maple 7909-60	W: Castle Oak 7928-38
Amber (74)	P: Millwork Cherry WC431-SD	F: Ginger Root Maple 7288-58	P: Taj Teak WT741-SD
Honey (75)	W: Brazilwood 7946-38	W: Brazilwood 7946-38	P: Wisconsin Oak WO581-SD
Nutmeg (76)	P: Spice Walnut WW561-SD	P: Spice Walnut WW561-SD	P: Spice Walnut WW561-SD
Henna (77)	P: Gunstock Savoy Walnut WW971-SD	P: Gunstock Savoy Walnut WW971-SD	P: Gunstock Savoy Walnut WW971-SD
Urban Cherry (78)	P: Sipping Seattle Java PFA48-SD	P: Sipping Seattle Java PFA48-SD	F: Select Cherry 7759-58
Mahogany (79)	W: Empire Mahogany 7122K-78	W: Empire Mahogany 7122K-78	W: Empire Mahogany 7122K-78
Sepia (80)	W: Studio Teak 7960K-18	W: Studio Teak 7960K-18	W: Studio Teak 7960K-18
Driftwood (409)	P: Pralines & Cream WW160-SD	P: Pralines & Cream WW160-SD	P: Pralines & Cream WW160-SD
Walnut (81)	W: Warehouse Oak 7969K-12	W: Warehouse Oak 7969K-12	W: Warehouse Oak 7969K-12
Molasses (82)	W: Cafelle 7933K-07	W: Cafelle 7933K-07	W: Cafelle 7933K-07
Black (83)	W: Black 1595-60	W: Black 1595-60	W: Black 1595-60

The chart above lists laminates which coordinate with our standard wood finishes. These are recommendations only – it is strongly recommended that samples are requested to ensure the match is satisfactory to individual customer preferences.

F: Formica N: Nevamar P: Pionite W: WilsonArt

URETHANE AND NYLON COLORS - ARM CAPS

Black Sable Dove

SOLID SURFACE OPTIONS

All standard, stocked colors are listed below. Call for more information.

Glacier White Linen Cameo White
Antarctica Bisque Dove

FLAT PVC AND 2MM BIO EDGE COLORS

Canton, Upland, Amigo, Dune, Sprout, Fuse, Tubular, Trumpet and Disc:
Silver, Black, Nickel, Soft White, Deep Taupe, Umber and Gray

2MM PVC WOOD GRAIN EDGE COLORS

Canton, Monroe, Upland, Amigo, Dune, Sprout, Fuse, Tubular, Trumpet and Disc: Asian Night, Cafelle, Empire Mahogany, Fusion Maple, New Age Oak, River Cherry, Studio Teak, Walnut Heights and Wild Cherry

Materials & Finish Options

	wood				non-wood			urethane			poly seat		nylon			metal powder coat			solid surface						plastic		
	oak	maple	beech	cherry	thermoform	laminated	engineered resin	black	sable	dove	black	sterling grey	black	sable	dove	black	silver	specialty	glacier white	carneo white	bisque	linen	antarctica	dove	black	white	light grey
Accord™		•			•	•		•	•	•					•	•	2	•	•	•	•	•	•				
Allay®		•			•			•	•	•					•	1		•	•	•	•	•	•				
Amari					•			•	•	•								•	•	•	•	•	•				
Amigo						•									•	•	2										
Canton			•			•		•	•	•					•	•	2	•	•	•	•	•	•				
Capital		•						•	•	•																	
Chancel	•	•	•	•																							
Cove		•						•	•	•					•			•	•	•	•	•	•				
Delta															•	•	2										
Dune			•			•									•	•	2										
Hale			•		•								•	•	•			•	•	•	•	•	•				
Latitude			•													•		•	•	•	•	•	•				
Link			•										•	•	•												
Laurelwood			•					•	•	•																	
Monroe			•			•		•																			
Oaklok	•	•	•	•																							
Perk						•																					
Plyfold			•																								
Plylok			•																								
Pose															•	•	2										
Rally		•				•										•											
sleepToo®		•				•		•	•	•					•	•	2	•	•	•	•	•	•				
Soul						•										•		•	•	•							
Sprout						•									•	•	2										
Trace			•			•	•	•	•	•						•											
Trey-G®												•															
Unity®	•	•	•	•																							
Upland												•	•		•	•	2								•	•	•
Vantage			•																								
Versant		•						•	•	•																	
Wedgewood			•					•	•	•																	
4700 Tables						•										•		•	•	•	•	•	•				
Fuse						•									•	•	2										
Trumpet & Disc						•									•	•	2										
Tubular						•									•	•	2										

1. Metal finish is natural aluminum and is a warmer tone than silver.
2. See Materials and Finishes section for additional specialty powder coat colors.

Order Checklist

Please use this checklist to assure that you are providing company the necessary information to accurately process your order. Correct information assures better lead times. If you have any questions, please contact your company sales representative.

GENERAL INFORMATION

- Bill To
- Ship To
- Project Name (Complete End User Information)
- Phone Number to Call for Questions
- Contact Name
- Unit Prices
- Discount Used
- Freight and Carrier Information
- Tagging Information
- Requested Delivery Date
- Contract Name and Number

SEATING UNITS

- Model Number
- Fabric Vendor
- Fabric Patterns
- Fabric Colors
- Plastic or Nylon Color
- Arm Cap Option
- Wood Species
- Wood or Metal Finish
- Solid Surface Color
- Flammability Upcharge, if applicable (CA TB133/Boston Fire Code)
- Zoning Diagram, if applicable

COM FABRIC

- 8" x 8" Fabric Memo Sample (Qty: 2)
- Fabric Vendor Name and Contact Information
- Fabric Pattern and Color
- Fabric Width
- Fabric Direction for Application
- Fabric Selvage Information (side or front)

TABLES

- Wood Species
- Wood or Metal Finish
- Laminate Name, Color and Finish Type
- Base Finish
- Edge Profile (if applicable)
- Edge Color (if applicable)
- Solid Surface Color

SUBMITTING FABRIC FOR PRODUCTION

- Job Name, City and State
- Purchase Order Number
- Send fabric directly to the address below, with the above information clearly marked on the roll:

Sauder® Manufacturing Co.
C/O Wieland
COM Fabric #XXXXXX (insert PO number)
10785 Rose Avenue
New Haven, IN 46774-9246

MODULAR SEATING

- Drawings of furniture layout

SPECIALS

- Is the Special clearly noted on the Purchase Order?
- Is the Special pricing reflected on the Purchase Order?

CONTRACTS

- Contract Name and Number
- Special notes associated with the contract

Seating & Coordinating Tables

Accord™ Recliner

CASTER/BRAKE OPTIONS

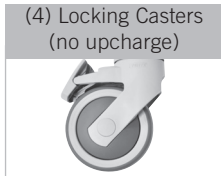

Specify black or grey.

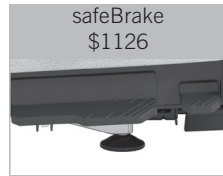

Includes safeBrake central lock with (4) swivel casters. Specify black or grey.



Includes safeBrake central lock and IntelliTrac™ caster system. Specify black or grey.

ARM CAP OPTIONS

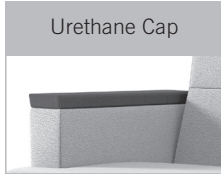

Standard. Specify black, sable or dove.



Specify wood finish.



Specify thermoform color.



Specify solid surface color.

ARM OPTIONS



Standard. Specify fabric.



Specify thermoform color. One panel is \$446.

ACCESSORIES

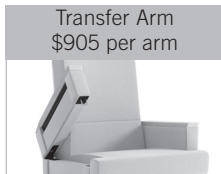

Specify right or left (as facing). Not available right side when flip table is specified.



Available right side only (as facing). Specify thermoform color.



Available right side only (as facing). Specify solid surface color.



Urethane only. Specify black, sable or dove.



Urethane only. Specify black, sable or dove.



Black only.



Available right side only (as facing). Not available when flip table is specified. Available with transfer arms.



Specify right or left (as facing). Not available on Transfer Arm side when specified.



21" seat height. Available with safeBrake option only. Not available when locking casters or IntelliTrac casters are specified.

Accord™ Recliner

OPTIONS

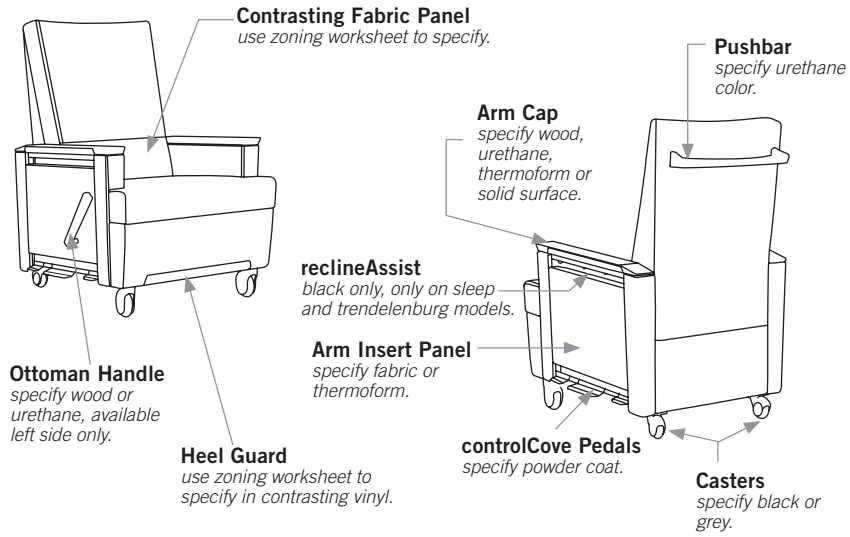

Accord™ Recliner



65981 PATIENT RECLINER

W: 28.75" D: 36" H: 46.25" SW: 21.5" SD: 22" SH: 20" AH: 26.5" WT: 142 lb COM: 5.75 yd WT CAP: 500 lb

ZONE	B/COM	C	D	E	F	G	H	I	J	GENERAL INFORMATION
1	6656	6771	6880	7018	7248	7473	7703	7927	8157	MATERIAL: Maple MOIS. BARR: Included
2	6820	6935	7044	7182	7412	7637	7867	8091	8321	
3	6984	7099	7208	7346	7576	7801	8031	8255	8485	
4	7148	7263	7372	7510	7740	7965	8195	8419	8649	

65W981 PATIENT RECLINER, WIDE

W: 30.75" D: 36" H: 46.25" SW: 23.5" SD: 22" SH: 20" AH: 26.5" WT: 146 lb COM: 6 yd WT CAP: 500 lb

ZONE	B/COM	C	D	E	F	G	H	I	J	GENERAL INFORMATION
1	7193	7313	7427	7571	7811	8045	8285	8519	8759	MATERIAL: Maple MOIS. BARR: Included
2	7370	7490	7604	7748	7988	8222	8462	8696	8936	
3	7548	7668	7782	7926	8166	8400	8640	8874	9114	
4	7725	7845	7959	8103	8343	8577	8817	9051	9291	

65981S SLEEP RECLINER

W: 28.75" D: 36" H: 46.25" SW: 21.5" SD: 22" SH: 20" AH: 26.5" WT: 150 lb COM: 5.75 yd WT CAP: 500 lb

ZONE	B/COM	C	D	E	F	G	H	I	J	GENERAL INFORMATION
1	7376	7491	7600	7738	7968	8193	8423	8647	8877	MATERIAL: Maple MOIS. BARR: Included
2	7558	7673	7782	7920	8150	8375	8605	8829	9059	
3	7740	7855	7964	8102	8332	8557	8787	9011	9241	
4	7922	8037	8146	8284	8514	8739	8969	9193	9423	

65W981S SLEEP RECLINER, WIDE

W: 30.75" D: 36" H: 46.25" SW: 23.5" SD: 22" SH: 20" AH: 26.5" WT: 154 lb COM: 6 yd WT CAP: 500 lb

ZONE	B/COM	C	D	E	F	G	H	I	J	GENERAL INFORMATION
1	7916	8036	8150	8294	8534	8768	9008	9242	9482	MATERIAL: Maple MOIS. BARR: Included
2	8112	8232	8346	8490	8730	8964	9204	9438	9678	
3	8307	8427	8541	8685	8925	9159	9399	9633	9873	
4	8502	8622	8736	8880	9120	9354	9594	9828	10068	

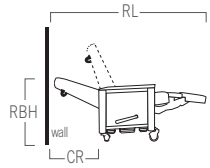

RL- Reclined length 74"

RBH- Reclined back height 28"

CR- Clearance required when placed against a wall is 24".

Dimensions above are based on standard Sleep Recliner model.

A 14" clearance is required from edge of chair when optional table is extended.

65981T TRENDELENBURG RECLINER

W: 28.75" D: 36" H: 46.25" SW: 21.5" SD: 22" SH: 20" AH: 26.5" WT: 158 lb COM: 5.75 yd WT CAP: 500 lb

ZONE	B/COM	C	D	E	F	G	H	I	J	GENERAL INFORMATION
1	7737	7852	7961	8099	8329	8554	8784	9008	9238	MATERIAL: Maple MOIS. BARR: Included
2	7928	8043	8152	8290	8520	8745	8975	9199	9429	
3	8119	8234	8343	8481	8711	8936	9166	9390	9620	
4	8310	8425	8534	8672	8902	9127	9357	9581	9811	

65W981T TRENDELENBURG RECLINER, WIDE

W: 30.75" D: 36" H: 46.25" SW: 23.5" SD: 22" SH: 20" AH: 26.5" WT: 162 lb COM: 6 yd WT CAP: 500 lb

ZONE	B/COM	C	D	E	F	G	H	I	J	GENERAL INFORMATION
1	8278	8398	8512	8656	8896	9130	9370	9604	9844	MATERIAL: Maple MOIS. BARR: Included
2	8483	8603	8717	8861	9101	9335	9575	9809	10049	
3	8687	8807	8921	9065	9305	9539	9779	10013	10253	
4	8892	9012	9126	9270	9510	9744	9984	10218	10458	

Specify:

- Product Number
- Wood Finish
- Fabric Vendor, Pattern and Color
- Urethane Color
- Thermoform Color
- Solid Surface Color
- Powder Coat Color
- Caster Color

See pages 16 & 17 for material and finish options.

Accord™ Sleep Chair

ARM CAP OPTIONS

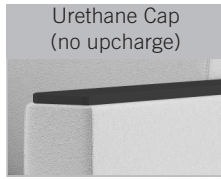

Standard. Specify black, sable or dove.



Specify solid surface color.



Specify thermoform color.



65841 SLEEP CHAIR

W: 30" D: 33.5" H: 33.25" SW: 24" SD: 21" SH: 18" AH: 25" WT: 110 lb COM: 5 yd WT CAP: 400 lb

ZONE	B/COM	C	D	E	F	G	H	I	J	GENERAL INFORMATION
1	7049	7149	7244	7364	7564	7759	7959	8154	8354	MATERIAL: Varies MOIS. BARR: Included
2	7223	7323	7418	7538	7738	7933	8133	8328	8528	
3	7397	7497	7592	7712	7912	8107	8307	8502	8702	
4	7572	7672	7767	7887	8087	8282	8482	8677	8877	

Casters are standard.

65W841 SLEEP CHAIR, WIDE

W: 36" D: 33.5" H: 33.25" SW: 30" SD: 21" SH: 18" AH: 25" WT: 128 lb COM: 6.5 yd WT CAP: 400 lb

ZONE	B/COM	C	D	E	F	G	H	I	J	GENERAL INFORMATION
1	7549	7679	7803	7959	8219	8472	8732	8986	9246	MATERIAL: Varies MOIS. BARR: Included
2	7735	7865	7989	8145	8405	8658	8918	9172	9432	
3	7921	8051	8175	8331	8591	8844	9104	9358	9618	
4	8107	8237	8361	8517	8777	9030	9290	9544	9804	

Casters are standard.

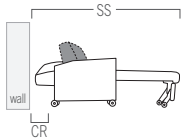

SS- Sleep surface 72"

CR- Clearance required to open sleep surface when placed against a wall is 10".

Specify:

- Product Number
- Fabric Vendor, Pattern and Color
- Urethane Color
- Solid Surface Color
- Thermoform Color

See pages 16 & 17 for material and finish options.

Allay® Sleep Sofa

ARM STYLES



600 Series

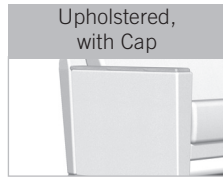

601 Series

Wood no upcharge
Urethane no upcharge
Solid surface \$351



Table Arm*
\$1198

Only available with solid surface top. Only available on 601 Series arm style. Specify solid surface color.

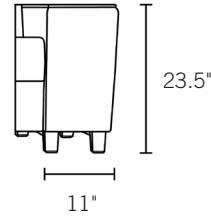

*Add 11" to sleep surface width for table arm and 4" for non-table arm to get overall width.

BASE OPTIONS

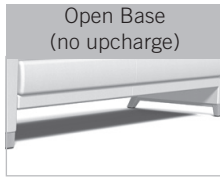

Open Base
(no upcharge)



Continuous Base
\$131

Fabric only.

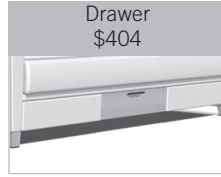

Drawer
\$404

Specify wood or thermoform. Not available on slim models.



Ottomans, Wood Panel
\$1009 each

Specify right, left, or dual ottomans (as facing). Upholstery panels provided when only one ottoman specified. Not available on slim models or with table arm.

TRUNDLE BED



Wood \$2328
Therm \$2658

Specify wood or thermoform. Clearance with trundle bed open is 28". Weight capacity is 400 lbs. Includes mattress. Not available on slim models.

LEG STYLES

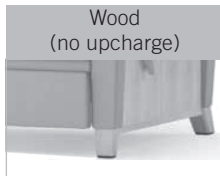

Wood
(no upcharge)



Metal Leg
\$470



Plinth Base
\$470

Plinth base cannot be used with ottomans and open base. Available only in black. Not available on slim models or with table arm.



Casters
\$508

Not available on trundle bed option.

BACK SUPPORT PANEL



Wood (no upcharge)
Thermoform \$404

Specify wood or thermoform.

BACK STYLES



Pull Back
(standard)



Straight Back
(no upcharge)

POWER OPTIONS



7700001 USB/120V
Outlet \$759

OR



7700002 120V/120V
Outlet \$641

Available in black or silver. Usable cord length is 9'. Please get facility approval on power options before ordering. Specify right, left, or both. Power units are UL Listed Tamper Resistant outlets. Available with table arm option only. Contact Customer Care for additional power options.

METAL SURFACE FINISH OPTIONS



Sleep Pull

Specify natural aluminum or black.

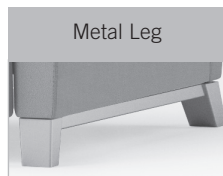

Metal Leg

Specify natural aluminum or black.



Drawer Pull
(if drawer is specified)

Specify natural aluminum or black.

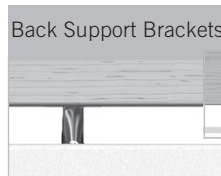

Back Support Brackets

Specify natural aluminum or black.



Rear view.

FINISH OPTIONS

Arm Cap
Specify wood, urethane or solid surface (on 601 series). When urethane arm cap is specified, ottoman handle will be urethane also.

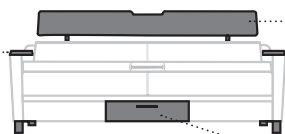

Back Support Panel
specify wood or thermoform

Drawer Front
specify wood or thermoform

Ottoman Handle
specify wood or urethane

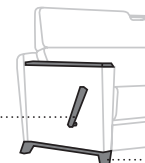

Leg Assembly
specify wood or metal

Allay® Sleep Sofa

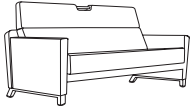

60066 SLEEP SOFA, SOFT TOP ARM, 66" SLEEP SURFACE, 74" WIDE

W: 74" D: 34" H: 38" SW: 66" SD: 21" SH: 18.5" AH: 23.5" WT: 171 lb COM: 12.25 yd WT CAP: 750 lb

ZONE	B/COM	C	D	E	F	G	H	I	J	GENERAL INFORMATION
1	7923	8168	8401	8695	9185	9663	10153	10630	11120	MATERIAL: Maple MOIS. BARR: Included
2	8116	8361	8594	8888	9378	9856	10346	10823	11313	
3	8309	8554	8787	9081	9571	10049	10539	11016	11506	
4	8503	8748	8981	9275	9765	10243	10733	11210	11700	

60069 SLEEP SOFA, SOFT TOP ARM, 69" SLEEP SURFACE, 77" WIDE

W: 77" D: 34" H: 38" SW: 69" SD: 21" SH: 18.5" AH: 23.5" WT: 177 lb COM: 12.25 yd WT CAP: 750 lb

ZONE	B/COM	C	D	E	F	G	H	I	J	GENERAL INFORMATION
1	8050	8295	8528	8822	9312	9790	10280	10757	11247	MATERIAL: Maple MOIS. BARR: Included
2	8246	8491	8724	9018	9508	9986	10476	10953	11443	
3	8443	8688	8921	9215	9705	10183	10673	11150	11640	
4	8639	8884	9117	9411	9901	10379	10869	11346	11836	

60072 SLEEP SOFA, SOFT TOP ARM, 72" SLEEP SURFACE, 80" WIDE

W: 80" D: 34" H: 38" SW: 72" SD: 21" SH: 18.5" AH: 23.5" WT: 183 lb COM: 12.25 yd WT CAP: 750 lb

ZONE	B/COM	C	D	E	F	G	H	I	J	GENERAL INFORMATION
1	8171	8416	8649	8943	9433	9911	10401	10878	11368	MATERIAL: Maple MOIS. BARR: Included
2	8370	8615	8848	9142	9632	10110	10600	11077	11567	
3	8570	8815	9048	9342	9832	10310	10800	11277	11767	
4	8769	9014	9247	9541	10031	10509	10999	11476	11966	

60075 SLEEP SOFA, SOFT TOP ARM, 75" SLEEP SURFACE, 83" WIDE

W: 83" D: 34" H: 38" SW: 75" SD: 21" SH: 18.5" AH: 23.5" WT: 189 lb COM: 12.25 yd WT CAP: 750 lb

ZONE	B/COM	C	D	E	F	G	H	I	J	GENERAL INFORMATION
1	8295	8540	8773	9067	9557	10035	10525	11002	11492	MATERIAL: Maple MOIS. BARR: Included
2	8497	8742	8975	9269	9759	10237	10727	11204	11694	
3	8700	8945	9178	9472	9962	10440	10930	11407	11897	
4	8902	9147	9380	9674	10164	10642	11132	11609	12099	

60078 SLEEP SOFA, SOFT TOP ARM, 78" SLEEP SURFACE, 86" WIDE

W: 86" D: 34" H: 38" SW: 78" SD: 21" SH: 18.5" AH: 23.5" WT: 195 lb COM: 12.25 yd WT CAP: 750 lb

ZONE	B/COM	C	D	E	F	G	H	I	J	GENERAL INFORMATION
1	8413	8658	8891	9185	9675	10153	10643	11120	11610	MATERIAL: Maple MOIS. BARR: Included
2	8618	8863	9096	9390	9880	10358	10848	11325	11815	
3	8824	9069	9302	9596	10086	10564	11054	11531	12021	
4	9029	9274	9507	9801	10291	10769	11259	11736	12226	

Specify:

- Product Number
- Wood Finish
- Urethane Color
- Fabric Vendor, Pattern and Color
- Thermoform Finish
- Solid Surface Color
- Metal Finish
- Base Option
- Leg Style Option
- Back Style Option
- Arm Style Option

See pages 16 & 17 for material and finish options.

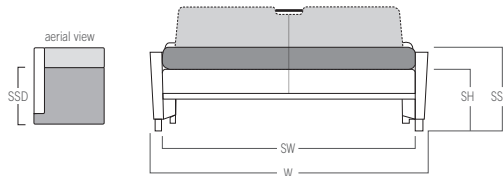

SSH- Sleep surface height 22.5"
 SSD- Sleep surface depth 30.5"
 SH- Seat height
 SW- Seat width
 W- Overall width
 Add 4" to overall width for each ottoman specified.
 Ottomans 14" from ground when extended.

Allay® Sleep Sofa

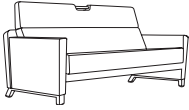

60166 SLEEP SOFA, UPH ARM W/CAP, 66" SLEEP SURFACE, 74" WIDE

W: 74" D: 34" H: 38" SW: 66" SD: 21" SH: 18.5" AH: 23.5" WT: 175 lb COM: 13 yd WT CAP: 750 lb

ZONE	B/COM	C	D	E	F	G	H	I	J	GENERAL INFORMATION
1	8485	8745	8992	9304	9824	10331	10851	11358	11878	MATERIAL: Maple MOIS. BARR: Included
2	8692	8952	9199	9511	10031	10538	11058	11565	12085	
3	8899	9159	9406	9718	10238	10745	11265	11772	12292	
4	9106	9366	9613	9925	10445	10952	11472	11979	12499	

60169 SLEEP SOFA, UPH ARM W/CAP, 69" SLEEP SURFACE, 77" WIDE

W: 77" D: 34" H: 38" SW: 69" SD: 21" SH: 18.5" AH: 23.5" WT: 181 lb COM: 13 yd WT CAP: 750 lb

ZONE	B/COM	C	D	E	F	G	H	I	J	GENERAL INFORMATION
1	8612	8872	9119	9431	9951	10458	10978	11485	12005	MATERIAL: Maple MOIS. BARR: Included
2	8822	9082	9329	9641	10161	10668	11188	11695	12215	
3	9032	9292	9539	9851	10371	10878	11398	11905	12425	
4	9242	9502	9749	10061	10581	11088	11608	12115	12635	

60172 SLEEP SOFA, UPH ARM W/CAP, 72" SLEEP SURFACE, 80" WIDE

W: 80" D: 34" H: 38" SW: 72" SD: 21" SH: 18.5" AH: 23.5" WT: 187 lb COM: 13 yd WT CAP: 750 lb

ZONE	B/COM	C	D	E	F	G	H	I	J	GENERAL INFORMATION
1	8728	8988	9235	9547	10067	10574	11094	11601	12121	MATERIAL: Maple MOIS. BARR: Included
2	8941	9201	9448	9760	10280	10787	11307	11814	12334	
3	9154	9414	9661	9973	10493	11000	11520	12027	12547	
4	9367	9627	9874	10186	10706	11213	11733	12240	12760	

60175 SLEEP SOFA, UPH ARM W/CAP, 75" SLEEP SURFACE, 83" WIDE

W: 83" D: 34" H: 38" SW: 75" SD: 21" SH: 18.5" AH: 23.5" WT: 193 lb COM: 13 yd WT CAP: 750 lb

ZONE	B/COM	C	D	E	F	G	H	I	J	GENERAL INFORMATION
1	8859	9119	9366	9678	10198	10705	11225	11732	12252	MATERIAL: Maple MOIS. BARR: Included
2	9075	9335	9582	9894	10414	10921	11441	11948	12468	
3	9292	9552	9799	10111	10631	11138	11658	12165	12685	
4	9508	9768	10015	10327	10847	11354	11874	12381	12901	

60178 SLEEP SOFA, UPH ARM W/CAP, 78" SLEEP SURFACE, 86" WIDE

W: 86" D: 34" H: 38" SW: 78" SD: 21" SH: 18.5" AH: 23.5" WT: 195 lb COM: 13 yd WT CAP: 750 lb

ZONE	B/COM	C	D	E	F	G	H	I	J	GENERAL INFORMATION
1	8980	9240	9487	9799	10319	10826	11346	11853	12373	MATERIAL: Maple MOIS. BARR: Included
2	9199	9459	9706	10018	10538	11045	11565	12072	12592	
3	9419	9679	9926	10238	10758	11265	11785	12292	12812	
4	9638	9898	10145	10457	10977	11484	12004	12511	13031	

Specify:

- Product Number
- Wood Finish
- Urethane Color
- Fabric Vendor, Pattern and Color
- Thermoform Finish
- Solid Surface Color
- Metal Finish
- Base Option
- Leg Style Option
- Back Style Option
- Arm Style Option

See pages 16 & 17 for material and finish options.

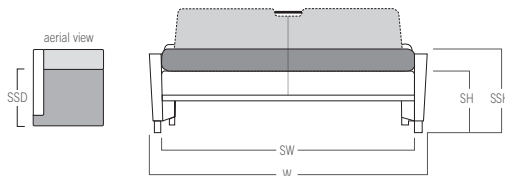

SSH- Sleep surface height 22.5"
 SSD- Sleep surface depth 30.5"
 SH- Seat height
 SW- Seat width
 W- Overall width
 Add 4" to overall width for each ottoman specified.
 Ottomans 14" from ground when extended.

Allay® Sleep Sofa Slim

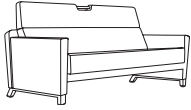

60066S SLEEP SOFA, SLIM, UPH ARM, 66" SLEEP SURFACE, 74" WIDE

W: 74" D: 30" H: 34" SW: 66" SD: 17" SH: 18.5" AH: 23.5" WT: 154 lb COM: 12 yd WT CAP: 750 lb

ZONE	B/COM	C	D	E	F	G	H	I	J	GENERAL INFORMATION
1	7919	8159	8387	8675	9155	9623	10103	10571	11051	MATERIAL: Maple
2	8112	8352	8580	8868	9348	9816	10296	10764	11244	MOIS. BARR: Included
3	8305	8545	8773	9061	9541	10009	10489	10957	11437	
4	8499	8739	8967	9255	9735	10203	10683	11151	11631	

60069S SLEEP SOFA, SLIM, UPH ARM, 69" SLEEP SURFACE, 77" WIDE

W: 77" D: 30" H: 34" SW: 69" SD: 17" SH: 18.5" AH: 23.5" WT: 160 lb COM: 12 yd WT CAP: 750 lb

ZONE	B/COM	C	D	E	F	G	H	I	J	GENERAL INFORMATION
1	8046	8286	8514	8802	9282	9750	10230	10698	11178	MATERIAL: Maple
2	8242	8482	8710	8998	9478	9946	10426	10894	11374	MOIS. BARR: Included
3	8439	8679	8907	9195	9675	10143	10623	11091	11571	
4	8635	8875	9103	9391	9871	10339	10819	11287	11767	

60072S SLEEP SOFA, SLIM, UPH ARM, 72" SLEEP SURFACE, 80" WIDE

W: 80" D: 30" H: 34" SW: 72" SD: 17" SH: 18.5" AH: 23.5" WT: 166 lb COM: 12 yd WT CAP: 750 lb

ZONE	B/COM	C	D	E	F	G	H	I	J	GENERAL INFORMATION
1	8167	8407	8635	8923	9403	9871	10351	10819	11299	MATERIAL: Maple
2	8366	8606	8834	9122	9602	10070	10550	11018	11498	MOIS. BARR: Included
3	8566	8806	9034	9322	9802	10270	10750	11218	11698	
4	8765	9005	9233	9521	10001	10469	10949	11417	11897	

60075S SLEEP SOFA, SLIM, UPH ARM, 75" SLEEP SURFACE, 83" WIDE

W: 83" D: 30" H: 34" SW: 75" SD: 17" SH: 18.5" AH: 23.5" WT: 172 lb COM: 12 yd WT CAP: 750 lb

ZONE	B/COM	C	D	E	F	G	H	I	J	GENERAL INFORMATION
1	8291	8531	8759	9047	9527	9995	10475	10943	11423	MATERIAL: Maple
2	8493	8733	8961	9249	9729	10197	10677	11145	11625	MOIS. BARR: Included
3	8696	8936	9164	9452	9932	10400	10880	11348	11828	
4	8898	9138	9366	9654	10134	10602	11082	11550	12030	

60078S SLEEP SOFA, SLIM, UPH ARM, 78" SLEEP SURFACE, 86" WIDE

W: 86" D: 30" H: 34" SW: 78" SD: 17" SH: 18.5" AH: 23.5" WT: 178 lb COM: 12 yd WT CAP: 750 lb

ZONE	B/COM	C	D	E	F	G	H	I	J	GENERAL INFORMATION
1	8409	8649	8877	9165	9645	10113	10593	11061	11541	MATERIAL: Maple
2	8614	8854	9082	9370	9850	10318	10798	11266	11746	MOIS. BARR: Included
3	8820	9060	9288	9576	10056	10524	11004	11472	11952	
4	9025	9265	9493	9781	10261	10729	11209	11677	12157	

Specify:

- Product Number
- Wood Finish
- Urethane Color
- Fabric Vendor, Pattern and Color
- Thermoform Finish
- Solid Surface Color
- Metal Finish
- Base Option
- Leg Style Option
- Back Style Option
- Arm Style Option

See pages 16 & 17 for material and finish options.

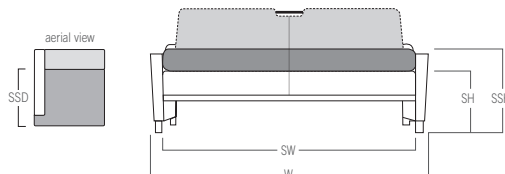

SSH- Sleep surface height 22.5"
 SSD- Sleep surface depth 17"
 SH- Seat height
 SW- Seat width
 W- Overall width

Allay® Sleep Sofa Slim

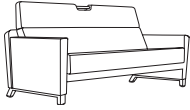

60166S SLEEP SOFA, SLIM, UPH ARM, ARM CAP, 66" SLEEP SURFACE, 74" WIDE

W: 74" D: 30" H: 34" SW: 66" SD: 17" SH: 18.5" AH: 23.5" WT: 158 lb COM: 12.5 yd WT CAP: 750 lb

ZONE	B/COM	C	D	E	F	G	H	I	J	GENERAL INFORMATION
1	8477	8727	8965	9265	9765	10252	10752	11240	11740	MATERIAL: Maple
2	8684	8934	9172	9472	9972	10459	10959	11447	11947	MOIS. BARR: Included
3	8891	9141	9379	9679	10179	10666	11166	11654	12154	
4	9098	9348	9586	9886	10386	10873	11373	11861	12361	

60169S SLEEP SOFA, SLIM UPH ARM, ARM CAP, 69" SLEEP SURFACE, 77" WIDE

W: 77" D: 30" H: 34" SW: 69" SD: 17" SH: 18.5" AH: 23.5" WT: 164 lb COM: 12.5 yd WT CAP: 750 lb

ZONE	B/COM	C	D	E	F	G	H	I	J	GENERAL INFORMATION
1	8604	8854	9092	9392	9892	10379	10879	11367	11867	MATERIAL: Maple
2	8814	9064	9302	9602	10102	10589	11089	11577	12077	MOIS. BARR: Included
3	9024	9274	9512	9812	10312	10799	11299	11787	12287	
4	9234	9484	9722	10022	10522	11009	11509	11997	12497	

60172S SLEEP SOFA, SLIM, UPH ARM, ARM CAP, 72" SLEEP SURFACE, 80" WIDE

W: 80" D: 30" H: 34" SW: 72" SD: 17" SH: 18.5" AH: 23.5" WT: 170 lb COM: 12.5 yd WT CAP: 750 lb

ZONE	B/COM	C	D	E	F	G	H	I	J	GENERAL INFORMATION
1	8720	8970	9208	9508	10008	10495	10995	11483	11983	MATERIAL: Maple
2	8933	9183	9421	9721	10221	10708	11208	11696	12196	MOIS. BARR: Included
3	9146	9396	9634	9934	10434	10921	11421	11909	12409	
4	9359	9609	9847	10147	10647	11134	11634	12122	12622	

60175S SLEEP SOFA, SLIM, UPH ARM, ARM CAP, 75" SLEEP SURFACE, 83" WIDE

W: 83" D: 30" H: 34" SW: 75" SD: 17" SH: 18.5" AH: 23.5" WT: 176 lb COM: 12.5 yd WT CAP: 750 lb

ZONE	B/COM	C	D	E	F	G	H	I	J	GENERAL INFORMATION
1	8851	9101	9339	9639	10139	10626	11126	11614	12114	MATERIAL: Maple
2	9067	9317	9555	9855	10355	10842	11342	11830	12330	MOIS. BARR: Included
3	9284	9534	9772	10072	10572	11059	11559	12047	12547	
4	9500	9750	9988	10288	10788	11275	11775	12263	12763	

60178S SLEEP SOFA, SLIM, UPH ARM, ARM CAP, 78" SLEEP SURFACE, 86" WIDE

W: 86" D: 30" H: 34" SW: 78" SD: 17" SH: 18.5" AH: 23.5" WT: 182 lb COM: 12.5 yd WT CAP: 750 lb

ZONE	B/COM	C	D	E	F	G	H	I	J	GENERAL INFORMATION
1	8972	9222	9460	9760	10260	10747	11247	11735	12235	MATERIAL: Maple
2	9191	9441	9679	9979	10479	10966	11466	11954	12454	MOIS. BARR: Included
3	9411	9661	9899	10199	10699	11186	11686	12174	12674	
4	9630	9880	10118	10418	10918	11405	11905	12393	12893	

Specify:

- Product Number
- Wood Finish
- Urethane Color
- Fabric Vendor, Pattern and Color
- Thermoform Finish
- Solid Surface Color
- Metal Finish
- Base Option
- Leg Style Option
- Back Style Option
- Arm Style Option

See pages 16 & 17 for material and finish options.

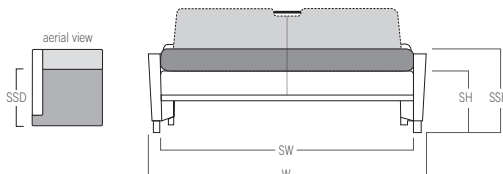

SSH- Sleep surface height 22.5"
 SSD- Sleep surface depth 17"
 SH- Seat height
 SW- Seat width
 W- Overall width

CASTER/BRAKE OPTIONS

(4) Locking Casters
(no upcharge)



Specify black or grey.

Central Brake
\$1085



Central brake with directional steering casters. Specify black or grey casters.

ARM CAP OPTIONS

Solid Surface
\$475



Specify solid surface color.

Urethane Cap
(no upcharge)



Standard. Specify black, sable or dove.

ARM PANEL OPTIONS

Solid Surface
\$746 per chair



Specify solid surface color.

Thermoform
(no upcharge)



Standard. Specify thermoform color.

ACCESSORIES

Transfer Arm
\$814 per arm



Specify right, left or both (as facing). Not available right side when flip table is specified.

Quick Release Seat
(14900-QR) \$272

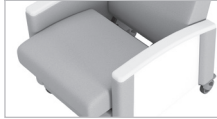

Full Flip Table
(14900-FT)

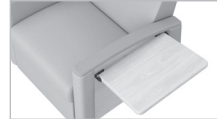

Available right side only (as facing). Specify color.
Thermoform \$475
Solid Surface \$951

Half Flip Table
(14900-FTP)



Available right side only (as facing). Specify color.
Thermoform \$475
Solid Surface \$951

Footrest (14900-FR)
\$483

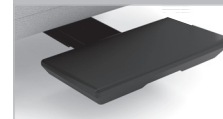

Black only.

Foley Bag Hook
(14900-BH) \$69



Available right side only (as facing). Not available when Full Flip Table is specified. Available with transfer arms.

Pushbar
(14900-PB) \$299

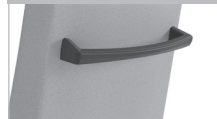

Urethane only. Specify black, sable or dove.



14981 AMARI RECLINER

W: 29" D: 34.25" H: 46.75" SW: 22" SD: 20.75" SH: 20" AH: 26.75" WT: 113 lb COM: 4 yd WT CAP: 500 lb

ZONE	B/COM	C	D	E	F	G	H	I	J	GENERAL INFORMATION
1	5729	5809	5885	5981	6141	6297	6457	6613	6773	MATERIAL: Varies MOIS. BARR: Included
2	5871	5951	6027	6123	6283	6439	6599	6755	6915	
3	6012	6092	6168	6264	6424	6580	6740	6896	7056	
4	6154	6234	6310	6406	6566	6722	6882	7038	7198	

14W981 AMARI RECLINER, WIDE

W: 32" D: 34.25" H: 46.75" SW: 25" SD: 20.75" SH: 20" AH: 26.75" WT: 125 lb COM: 4.25 yd WT CAP: 500 lb

ZONE	B/COM	C	D	E	F	G	H	I	J	GENERAL INFORMATION
1	6144	6229	6310	6412	6582	6748	6918	7083	7253	MATERIAL: Varies MOIS. BARR: Included
2	6296	6381	6462	6564	6734	6900	7070	7235	7405	
3	6448	6533	6614	6716	6886	7052	7222	7387	7557	
4	6600	6685	6766	6868	7038	7204	7374	7539	7709	

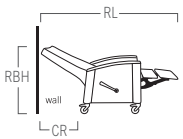

RL- Reclined length 70.5"

RBH- Reclined back height 34.5"

CR- Clearance required when placed against a wall is 20.5".

A 12.5 " clearance is required from edge of chair when optional table is extended.

Specify:

- Product Number
- Fabric Vendor, Pattern and Color
- Urethane Color
- Thermoform Color
- Solid Surface Color
- Caster Color

Amigo Occasional Tables



8915DSK022 OCCASIONAL TABLE, 15" ROUND TOP, 22" HT

GENERAL INFORMATION

W: 15" D: 15" H: 22" WT: 26 lb WT CAP: 200 lb

BASE MATERIAL: Metal
TOP MATERIAL: Laminate

Zone	1	2	3	4
	952	976	1000	1023

Round laminate top with metal base. Specify laminate, edge style and metal finish when ordering.

8915DSK025 OCCASIONAL TABLE, 15" ROUND TOP, 25" HT

GENERAL INFORMATION

W: 15" D: 15" H: 25" WT: 26 lb WT CAP: 200 lb

BASE MATERIAL: Metal
TOP MATERIAL: Laminate

Zone	1	2	3	4
	952	976	1000	1023

Round laminate top with metal base. Specify laminate, edge style and metal finish when ordering.

8915DSK027 OCCASIONAL TABLE, 15" ROUND TOP, 27" HT

GENERAL INFORMATION

W: 15" D: 15" H: 27" WT: 26 lb WT CAP: 200 lb

BASE MATERIAL: Metal
TOP MATERIAL: Laminate

Zone	1	2	3	4
	952	976	1000	1023

Round laminate top with metal base. Specify laminate, edge style and metal finish when ordering.

8918DSK022 OCCASIONAL TABLE, 18" ROUND TOP, 22" HT

GENERAL INFORMATION

W: 18" D: 18" H: 22" WT: 33 lb WT CAP: 200 lb

BASE MATERIAL: Metal
TOP MATERIAL: Laminate

Zone	1	2	3	4
	1052	1078	1105	1131

Round laminate top with metal base. Specify laminate, edge style and metal finish when ordering.

8918DSK025 OCCASIONAL TABLE, 18" ROUND TOP, 25" HT

GENERAL INFORMATION

W: 18" D: 18" H: 25" WT: 33 lb WT CAP: 200 lb

BASE MATERIAL: Metal
TOP MATERIAL: Laminate

Zone	1	2	3	4
	1052	1078	1105	1131

Round laminate top with metal base. Specify laminate, edge style and metal finish when ordering.

8918DSK027 OCCASIONAL TABLE, 18" ROUND TOP, 27" HT

GENERAL INFORMATION

W: 18" D: 18" H: 27" WT: 33 lb WT CAP: 200 lb

BASE MATERIAL: Metal
TOP MATERIAL: Laminate

Zone	1	2	3	4
	1052	1078	1105	1131

Round laminate top with metal base. Specify laminate, edge style and metal finish when ordering.

Edge Style Options

Specify:

- Product Number
- Metal Finish
- Edge Style and Finish
- Laminate Vendor, Pattern and Finish

See pages 16 & 17 for material and finish options.

FLAT PVC EDGE

Available in 7 colors to match metal finishes.



2MM BIO EDGE

Available in 7 colors to match metal finishes.



SELF EDGE

Matches top laminate.



2MM PVC WOOD GRAIN EDGE

Available in 9 wood grain colors to match standard laminates.

Amigo Occasional Tables



8922DSK022 OCCASIONAL TABLE, 22" ROUND TOP, 22" HT

GENERAL INFORMATION

W: 22" D: 22" H: 22" WT: 44 lb WT CAP: 200 lb

BASE MATERIAL: Metal
TOP MATERIAL: Laminate

Zone	1	2	3	4
	1218	1248	1279	1309

Round laminate top with metal base. Specify laminate, edge style and metal finish when ordering.

8922DSK025 OCCASIONAL TABLE, 22" ROUND TOP, 25" HT

GENERAL INFORMATION

W: 22" D: 22" H: 25" WT: 44 lb WT CAP: 200 lb

BASE MATERIAL: Metal
TOP MATERIAL: Laminate

Zone	1	2	3	4
	1218	1248	1279	1309

Round laminate top with metal base. Specify laminate, edge style and metal finish when ordering.

8922DSK027 OCCASIONAL TABLE, 22" ROUND TOP, 27" HT

GENERAL INFORMATION

W: 22" D: 22" H: 27" WT: 44 lb WT CAP: 200 lb

BASE MATERIAL: Metal
TOP MATERIAL: Laminate

Zone	1	2	3	4
	1218	1248	1279	1309

Round laminate top with metal base. Specify laminate, edge style and metal finish when ordering.



8915SQSK022 OCCASIONAL TABLE, 15" SQUARE TOP, 22" HT

GENERAL INFORMATION

W: 15" D: 15" H: 22" WT: 27 lb WT CAP: 200 lb

BASE MATERIAL: Metal
TOP MATERIAL: Laminate

Zone	1	2	3	4
	862	884	905	927

Square laminate top with metal base. Specify laminate, edge style & finish and metal finish when ordering.

8915SQSK025 OCCASIONAL TABLE, 15" SQUARE TOP, 25" HT

GENERAL INFORMATION

W: 15" D: 15" H: 25" WT: 27 lb WT CAP: 200 lb

BASE MATERIAL: Metal
TOP MATERIAL: Laminate

Zone	1	2	3	4
	862	884	905	927

Square laminate top with metal base. Specify laminate, edge style & finish and metal finish when ordering.

8915SQSK027 OCCASIONAL TABLE, 15" SQUARE TOP, 27" HT

GENERAL INFORMATION

W: 15" D: 15" H: 27" WT: 27 lb WT CAP: 200 lb

BASE MATERIAL: Metal
TOP MATERIAL: Laminate

Zone	1	2	3	4
	862	884	905	927

Square laminate top with metal base. Specify laminate, edge style & finish and metal finish when ordering.

Edge Style Options

- Specify:
- Product Number
 - Metal Finish
 - Edge Style and Finish
 - Laminate Vendor, Pattern and Finish

See pages 16 & 17 for material and finish options.



FLAT PVC EDGE

Available in 7 colors to match metal finishes.



SELF EDGE

Matches top laminate.



2MM BIO EDGE

Available in 7 colors to match metal finishes.



2MM PVC WOOD GRAIN EDGE

Available in 9 wood grain colors to match standard laminates.

Amigo Occasional Tables



8918SQSK022 OCCASIONAL TABLE, 18" SQUARE TOP, 22" HT

GENERAL INFORMATION

W: 18" D: 18" H: 22" WT: 35 lb WT CAP: 200 lb

BASE MATERIAL: Metal
TOP MATERIAL: Laminate

Zone	1	2	3	4
	998	1023	1048	1073

Square laminate top with metal base. Specify laminate, edge style & finish and metal finish when ordering.

8918SQSK025 OCCASIONAL TABLE, 18" SQUARE TOP, 25" HT

GENERAL INFORMATION

W: 18" D: 18" H: 25" WT: 35 lb WT CAP: 200 lb

BASE MATERIAL: Metal
TOP MATERIAL: Laminate

Zone	1	2	3	4
	998	1023	1048	1073

Square laminate top with metal base. Specify laminate, edge style & finish and metal finish when ordering.

8918SQSK027 OCCASIONAL TABLE, 18" SQUARE TOP, 27" HT

GENERAL INFORMATION

W: 18" D: 18" H: 27" WT: 35 lb WT CAP: 200 lb

BASE MATERIAL: Metal
TOP MATERIAL: Laminate

Zone	1	2	3	4
	998	1023	1048	1073

Square laminate top with metal base. Specify laminate, edge style & finish and metal finish when ordering.

8922SQSK022 OCCASIONAL TABLE, 22" SQUARE TOP, 22" HT

GENERAL INFORMATION

W: 22" D: 22" H: 22" WT: 47 lb WT CAP: 200 lb

BASE MATERIAL: Metal
TOP MATERIAL: Laminate

Zone	1	2	3	4
	1166	1195	1224	1253

Square laminate top with metal base. Specify laminate, edge style & finish and metal finish when ordering.

8922SQSK025 OCCASIONAL TABLE, 22" SQUARE TOP, 25" HT

GENERAL INFORMATION

W: 22" D: 22" H: 25" WT: 48 lb WT CAP: 200 lb

BASE MATERIAL: Metal
TOP MATERIAL: Laminate

Zone	1	2	3	4
	1166	1195	1224	1253

Square laminate top with metal base. Specify laminate, edge style & finish and metal finish when ordering.

8922SQSK027 OCCASIONAL TABLE, 22" SQUARE TOP, 27" HT

GENERAL INFORMATION

W: 22" D: 22" H: 27" WT: 48 lb WT CAP: 200 lb

BASE MATERIAL: Metal
TOP MATERIAL: Laminate

Zone	1	2	3	4
	1166	1195	1224	1253

Square laminate top with metal base. Specify laminate, edge style & finish and metal finish when ordering.

Edge Style Options

Specify:

- Product Number
- Metal Finish
- Edge Style
- Laminate Vendor, Pattern and Finish

See pages 16 & 17 for material and finish options.



FLAT PVC EDGE

Available in 7 colors to match metal finishes.



2MM BIO EDGE

Available in 7 colors to match metal finishes.



SELF EDGE

Matches top laminate.



2MM PVC WOOD GRAIN EDGE

Available in 9 wood grain colors to match standard laminates.

SIDE RAIL OPTIONS



Specify wood finish.

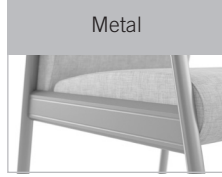

Specify metal color.

ARM CAP OPTIONS



Specify wood finish.



Specify black, sable or dove.



Specify solid surface color.

FREESTANDING TABLE EDGE OPTIONS

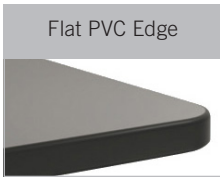

Available in 7 colors to match metal finishes.

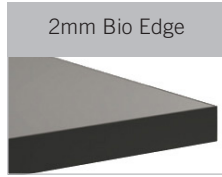

Available in 7 colors to match metal finishes.

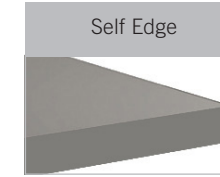

Specify laminate color.

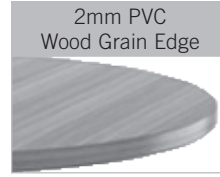

Available in 9 wood grain colors to match standard laminates.

MODULAR TABLE EDGE OPTIONS

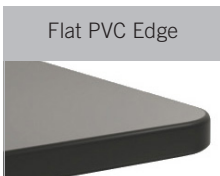

Available in 7 colors to match metal finishes.

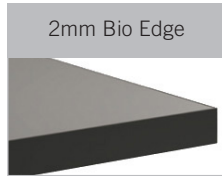

Available in 7 colors to match metal finishes.

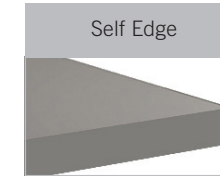

Specify laminate color.

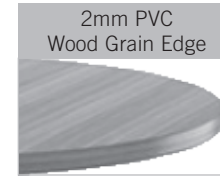

Available in 9 wood grain colors to match standard laminates.

ACCESSORIES



Canton



67CN01M CHAIR, METAL FRAME

W: 25" D: 26" H: 33.75" SW: 21" SD: 18" SH: 18" AH: 25" WT: 27 lb COM: 1.75 yd WT CAP: 500 lb

ZONE	B/COM	C	D	E	F	G	H	I	J	GENERAL INFORMATION
1	1702	1737	1770	1812	1882	1951	2021	2089	2159	MATERIAL: Maple MOIS. BARR: \$21
2	1744	1779	1812	1854	1924	1993	2063	2131	2201	
3	1786	1821	1854	1896	1966	2035	2105	2173	2243	
4	1828	1863	1896	1938	2008	2077	2147	2215	2285	

Wallsaver legs are standard.

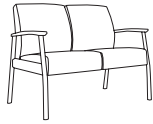

67CN02M LOVESEAT, METAL FRAME

W: 44.75" D: 26" H: 33.75" SW: 21" SD: 18" SH: 18" AH: 25" WT: 51 lb COM: 3.5 yd WT CAP: 750 lb

ZONE	B/COM	C	D	E	F	G	H	I	J	GENERAL INFORMATION
1	2800	2870	2937	3021	3161	3297	3437	3574	3714	MATERIAL: Maple MOIS. BARR: \$42
2	2869	2939	3006	3090	3230	3366	3506	3643	3783	
3	2937	3007	3074	3158	3298	3434	3574	3711	3851	
4	3006	3076	3143	3227	3367	3503	3643	3780	3920	

Wallsaver legs are standard.

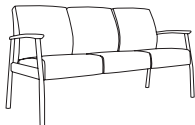

67CN03M SOFA, METAL FRAME

W: 67.5" D: 26" H: 33.75" SW: 21" SD: 18" SH: 18" AH: 25" WT: 75 COM: 5.25 yd WT CAP: 1000 lb

ZONE	B/COM	C	D	E	F	G	H	I	J	GENERAL INFORMATION
1	3801	3906	4006	4132	4342	4547	4757	4961	5171	MATERIAL: Maple MOIS. BARR: \$63
2	3894	3999	4099	4225	4435	4640	4850	5054	5264	
3	3987	4092	4192	4318	4528	4733	4943	5147	5357	
4	4080	4185	4285	4411	4621	4826	5036	5240	5450	

Wallsaver legs are standard.



67CN12M LOVESEAT, METAL FRAME, SHORT CENTER ARMS

W: 48" D: 26" H: 33.75" SW: 21" SD: 18" SH: 18" AH: 25" WT: 51 lb COM: 3.5 yd WT CAP: 750 lb

ZONE	B/COM	C	D	E	F	G	H	I	J	GENERAL INFORMATION
1	3093	3163	3230	3314	3454	3590	3730	3867	4007	MATERIAL: Maple MOIS. BARR: \$42
2	3169	3239	3306	3390	3530	3666	3806	3943	4083	
3	3245	3315	3382	3466	3606	3742	3882	4019	4159	
4	3321	3391	3458	3542	3682	3818	3958	4095	4235	

Wallsaver legs are standard.

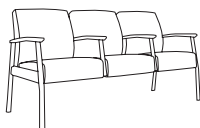

67CN13M SOFA, METAL FRAME, SHORT CENTER ARMS

W: 70.5" D: 26" H: 33.75" SW: 21" SD: 18" SH: 18" AH: 25" WT: 75 lb COM: 5.25 yd WT CAP: 1000 lb

ZONE	B/COM	C	D	E	F	G	H	I	J	GENERAL INFORMATION
1	4342	4447	4547	4673	4883	5088	5298	5502	5712	MATERIAL: Maple MOIS. BARR: \$63
2	4448	4553	4653	4779	4989	5194	5404	5608	5818	
3	4555	4660	4760	4886	5096	5301	5511	5715	5925	
4	4661	4766	4866	4992	5202	5407	5617	5821	6031	

Wallsaver legs are standard.

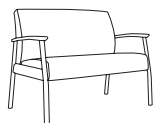

67CN01L LOVESEAT, METAL FRAME, CONTINUOUS SEAT

W: 46" D: 26" H: 33.75" SW: 42" SD: 18" SH: 18" AH: 25" WT: 51 lb COM: 3.5 yd WT CAP: 750 lb

ZONE	B/COM	C	D	E	F	G	H	I	J	GENERAL INFORMATION
1	2659	2729	2796	2880	3020	3156	3296	3433	3573	MATERIAL: Maple MOIS. BARR: \$42
2	2724	2794	2861	2945	3085	3221	3361	3498	3638	
3	2789	2859	2926	3010	3150	3286	3426	3563	3703	
4	2854	2924	2991	3075	3215	3351	3491	3628	3768	

Wallsaver legs are standard.

Specify:

- Product Number
- Wood Finish
- Metal Finish
- Urethane Cap Color
- Side Rail Option

See pages 16 & 17 for material and finish options.



67CN01G CHAIR, WIDE, METAL FRAME, BARIATRIC

W: 34" D: 26" H: 33.75" SW: 30" SD: 18" SH: 18" AH: 25" WT: 34 lb COM: 3 yd WT CAP: 750 lb

ZONE	B/COM	C	D	E	F	G	H	I	J	GENERAL INFORMATION
1	2164	2224	2281	2353	2473	2590	2710	2827	2947	MATERIAL: Maple MOIS. BARR: \$36
2	2217	2277	2334	2406	2526	2643	2763	2880	3000	
3	2270	2330	2387	2459	2579	2696	2816	2933	3053	
4	2323	2383	2440	2512	2632	2749	2869	2986	3106	

Wallsaver legs are standard.



67CN01H PATIENT CHAIR, METAL FRAME, HIGH BACK

W: 25" D: 26" H: 47.5" SW: 21" SD: 18" SH: 18" AH: 25" WT: 47 lb COM: 2.5 yd WT CAP: 500 lb

ZONE	B/COM	C	D	E	F	G	H	I	J	GENERAL INFORMATION
1	1902	1952	2000	2060	2160	2257	2357	2455	2555	MATERIAL: Maple MOIS. BARR: \$30
2	1949	1999	2047	2107	2207	2304	2404	2502	2602	
3	1995	2045	2093	2153	2253	2350	2450	2548	2648	
4	2042	2092	2140	2200	2300	2397	2497	2595	2695	

Wallsaver legs are not available.



67CN01ME EASY ACCESS CHAIR, METAL FRAME

W: 25" D: 26" H: 46" SW: 21" SD: 18" SH: 24" AH: 32" WT: 35 lb COM: 1.75 yd WT CAP: 500 lb

ZONE	B/COM	C	D	E	F	G	H	I	J	GENERAL INFORMATION
1	1862	1897	1930	1972	2042	2111	2181	2249	2319	MATERIAL: Maple MOIS. BARR: \$21
2	1908	1943	1976	2018	2088	2157	2227	2295	2365	
3	1954	1989	2022	2064	2134	2203	2273	2341	2411	
4	2000	2035	2068	2110	2180	2249	2319	2387	2457	

Wallsaver legs are standard.

Specify:

- Product Number
- Wood Finish
- Metal Finish
- Urethane Cap Color
- Side Rail Option

**See pages 16 & 17
for material and finish
options.**

Canton Tables



67CN2424SQ FREESTANDING END TABLE, 24"

GENERAL INFORMATION

W: 24" D: 24" H: 18" WT: 47 lb

MATERIAL: Metal and Laminate
MOIS BARR: -

Zone	1	2	3	4
	981	1006	1030	1055

Price includes hard plastic clear glides. Laminate top with metal legs. Specify laminate, edge style & metal finish when ordering.

67CN3030SQ FREESTANDING END TABLE, 30"

GENERAL INFORMATION

W: 30" D: 30" H: 18" WT: 57 lb

MATERIAL: Metal and Laminate
MOIS BARR: -

Zone	1	2	3	4
	1142	1171	1199	1228

Price includes hard plastic clear glides. Laminate top with metal legs. Specify laminate, edge style & metal finish when ordering.



67CN22DIA FREESTANDING END TABLE, ROUND

GENERAL INFORMATION

W: 22" D: 22" H: 18" WT: 47 lb

MATERIAL: Metal and Laminate
MOIS BARR: -

Zone	1	2	3	4
	1226	1257	1287	1318

Price includes hard plastic clear glides. Laminate top with metal legs. Specify laminate, edge style & metal finish when ordering.

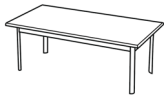

67CN2448RE FREESTANDING COFFEE TABLE, RECTANGULAR

GENERAL INFORMATION

W: 48" D: 24" H: 18" WT: 64 lb

MATERIAL: Metal and Laminate
MOIS BARR: -

Zone	1	2	3	4
	1229	1260	1290	1321

Price includes hard plastic clear glides. Laminate top with metal legs. Specify laminate, edge style & metal finish when ordering.

Specify:

- Product Number
- Metal Finish
- Edge Style & Finish
- Laminate Vendor, Name and Number

See pages 16 & 17 for material and finish options.

Canton Modular Tables



67CNTC45DEG CORNER TABLE, ANGLED, MODULAR

W: - D: - H: 18" WT: 19 lb

Zone	1	2	3	4
	1278	1310	1342	1374

GENERAL INFORMATION

MATERIAL: Metal and Laminate
MOIS BARR: -

Laminate top. Specify laminate and edge style when ordering. Modular seating orders must include a layout to ensure proper configuration.

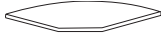

67CNRC2828 CORNER TABLE, RADIUS, MODULAR

W: 28" D: 18" H: 18" WT: 26 lb

Zone	1	2	3	4
	1278	1310	1342	1374

GENERAL INFORMATION

MATERIAL: Metal and Laminate
MOIS BARR: -

Laminate top. Specify laminate and edge style when ordering. Modular seating orders must include a layout to ensure proper configuration.



67CNSC2828 CORNER TABLE, SQUARE, MODULAR

W: 28" D: 28" H: 18" WT: 26 lb

Zone	1	2	3	4
	1398	1433	1468	1503

GENERAL INFORMATION

MATERIAL: Metal and Laminate
MOIS BARR: -

Laminate top. Specify laminate and edge style when ordering. Modular seating orders must include a layout to ensure proper configuration.



67CNST2121 SPANNER TABLE, MODULAR

W: 21" D: 21" H: 18" WT: 19 lb

Zone	1	2	3	4
	867	889	910	932

GENERAL INFORMATION

MATERIAL: Metal and Laminate
MOIS BARR: -

Laminate top. Specify laminate and edge style when ordering. Modular seating orders must include a layout to ensure proper configuration.

67CNET2121 END TABLE, MODULAR

W: 21" D: 21" H: 18" WT: 19 lb

Zone	1	2	3	4
	1158	1187	1216	1245

GENERAL INFORMATION

MATERIAL: Metal and Laminate
MOIS BARR: -

Laminate top. Specify laminate and edge style when ordering. Modular seating orders must include a layout to ensure proper configuration.

Specify:

- Product Number
- Edge Style & Finish
- Laminate Vendor, Name and Number

See pages 16 & 17 for material and finish options.

Capital Gliders



32151G20 GLIDER, 20" SEAT, UPH ARM

W: 27.5" D: 30" H: 42" SW: 20" SD: 19.5" SH: 18.5" AH: 24.75" WT: 56 lb COM: 3.75 yd WT CAP: 350 lb

ZONE	B/COM	C	D	E	F	G	H	I	J	GENERAL INFORMATION
1	3987	4062	4133	4223	4373	4520	4670	4816	4966	MATERIAL: - MOIS. BARR: Included
2	4085	4160	4231	4321	4471	4618	4768	4914	5064	
3	4183	4258	4329	4419	4569	4716	4866	5012	5162	
4	4282	4357	4428	4518	4668	4815	4965	5111	5261	

The glider range from forward point to rear point is 41". A 7" clearance is required when placed against a wall.

32151G22 GLIDER, 22" SEAT, UPH ARM

W: 29.5" D: 30" H: 42" SW: 22" SD: 19.5" SH: 18.5" AH: 24.75" WT: 59 lb COM: 3.75 yd WT CAP: 350 lb

ZONE	B/COM	C	D	E	F	G	H	I	J	GENERAL INFORMATION
1	4156	4231	4302	4392	4542	4689	4839	4985	5135	MATERIAL: - MOIS. BARR: Included
2	4258	4333	4404	4494	4644	4791	4941	5087	5237	
3	4361	4436	4507	4597	4747	4894	5044	5190	5340	
4	4463	4538	4609	4699	4849	4996	5146	5292	5442	

The glider range from forward point to rear point is 41". A 7" clearance is required when placed against a wall.

32151G24 GLIDER, 24" SEAT, UPH ARM

W: 31.5" D: 30" H: 42" SW: 24" SD: 19.5" SH: 18.5" AH: 24.75" WT: 62 lb COM: 4 yd WT CAP: 350 lb

ZONE	B/COM	C	D	E	F	G	H	I	J	GENERAL INFORMATION
1	4328	4408	4484	4580	4740	4896	5056	5212	5372	MATERIAL: - MOIS. BARR: Included
2	4435	4515	4591	4687	4847	5003	5163	5319	5479	
3	4541	4621	4697	4793	4953	5109	5269	5425	5585	
4	4648	4728	4804	4900	5060	5216	5376	5532	5692	

The glider range from forward point to rear point is 41". A 7" clearance is required when placed against a wall.



32651G20 GLIDER, 20" SEAT, UPH ARM, URETHANE CAP

W: 27.5" D: 30" H: 42" SW: 20" SD: 19.5" SH: 18.5" AH: 24.75" WT: 58 lb COM: 3.75 yd WT CAP: 350 lb

ZONE	B/COM	C	D	E	F	G	H	I	J	GENERAL INFORMATION
1	4320	4395	4466	4556	4706	4853	5003	5149	5299	MATERIAL: - MOIS. BARR: Included
2	4426	4501	4572	4662	4812	4959	5109	5255	5405	
3	4533	4608	4679	4769	4919	5066	5216	5362	5512	
4	4640	4715	4786	4876	5026	5173	5323	5469	5619	

Urethane arm caps are available in black, sable or dove. The glider range from forward point to rear point is 41". A 7" clearance is required when placed against a wall.

32651G22 GLIDER, 22" SEAT, UPH ARM, URETHANE CAP

W: 29.5" D: 30" H: 42" SW: 22" SD: 19.5" SH: 18.5" AH: 24.75" WT: 61 lb COM: 3.75 yd WT CAP: 350 lb

ZONE	B/COM	C	D	E	F	G	H	I	J	GENERAL INFORMATION
1	4486	4561	4632	4722	4872	5019	5169	5315	5465	MATERIAL: - MOIS. BARR: Included
2	4597	4672	4743	4833	4983	5130	5280	5426	5576	
3	4707	4782	4853	4943	5093	5240	5390	5536	5686	
4	4818	4893	4964	5054	5204	5351	5501	5647	5797	

Urethane arm caps are available in black, sable or dove. The glider range from forward point to rear point is 41". A 7" clearance is required when placed against a wall.

32651G24 GLIDER, 24" SEAT, UPH ARM, URETHANE CAP

W: 31.5" D: 30" H: 42" SW: 24" SD: 19.5" SH: 18.5" AH: 24.75" WT: 64 lb COM: 3.75 yd WT CAP: 350 lb

ZONE	B/COM	C	D	E	F	G	H	I	J	GENERAL INFORMATION
1	4630	4705	4776	4866	5016	5163	5313	5459	5609	MATERIAL: - MOIS. BARR: Included
2	4744	4819	4890	4980	5130	5277	5427	5573	5723	
3	4858	4933	5004	5094	5244	5391	5541	5687	5837	
4	4973	5048	5119	5209	5359	5506	5656	5802	5952	

Urethane arm caps are available in black, sable or dove. The glider range from forward point to rear point is 41". A 7" clearance is required when placed against a wall.

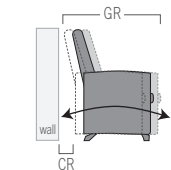

GR- Glider range from forward point to rear point is 41"

CR- Clearance required when placed against a wall is 7"

Specify:

- Product Number
- Urethane Cap Color
- Fabric Vendor, Pattern and Color

See pages 16 & 17 for material and finish options.

Capital Gliders



32151LG20 GLIDER, 20" SEAT, UPH ARM, LOCKING MECHANISM

W: 27.5" D: 30" H: 42" SW: 20" SD: 19.5" SH: 18.5" AH: 24.75" WT: 58 lb COM: 3.75 yd WT CAP: 350 lb

ZONE	B/COM	C	D	E	F	G	H	I	J	GENERAL INFORMATION
1	4262	4337	4408	4498	4648	4795	4945	5091	5241	MATERIAL: -
2	4367	4442	4513	4603	4753	4900	5050	5196	5346	MOIS. BARR: Included
3	4472	4547	4618	4708	4858	5005	5155	5301	5451	
4	4577	4652	4723	4813	4963	5110	5260	5406	5556	

The glider range from forward point to rear point is 41". A 7" clearance is required when placed against a wall.

32151LG22 GLIDER, 22" SEAT, UPH ARM, LOCKING MECHANISM

W: 29.5" D: 30" H: 42" SW: 22" SD: 19.5" SH: 18.5" AH: 24.75" WT: 61 lb COM: 3.75 yd WT CAP: 350 lb

ZONE	B/COM	C	D	E	F	G	H	I	J	GENERAL INFORMATION
1	4442	4517	4588	4678	4828	4975	5125	5271	5421	MATERIAL: -
2	4552	4627	4698	4788	4938	5085	5235	5381	5531	MOIS. BARR: Included
3	4661	4736	4807	4897	5047	5194	5344	5490	5640	
4	4771	4846	4917	5007	5157	5304	5454	5600	5750	

The glider range from forward point to rear point is 41". A 7" clearance is required when placed against a wall.

32151LG24 GLIDER, 24" SEAT, UPH ARM, LOCKING MECHANISM

W: 31.5" D: 30" H: 42" SW: 24" SD: 19.5" SH: 18.5" AH: 24.75" WT: 64 lb COM: 4 yd WT CAP: 350 lb

ZONE	B/COM	C	D	E	F	G	H	I	J	GENERAL INFORMATION
1	4607	4687	4763	4859	5019	5175	5335	5491	5651	MATERIAL: -
2	4721	4801	4877	4973	5133	5289	5449	5605	5765	MOIS. BARR: Included
3	4834	4914	4990	5086	5246	5402	5562	5718	5878	
4	4948	5028	5104	5200	5360	5516	5676	5832	5992	

The glider range from forward point to rear point is 41". A 7" clearance is required when placed against a wall.



32651LG20 GLIDER, 20" SEAT, UPH ARM, URETHANE CAP, LOCKING MECHANISM

W: 27.5" D: 30" H: 42" SW: 20" SD: 19.5" SH: 18.5" AH: 24.75" WT: 58 lb COM: 3.75 yd WT CAP: 350 lb

ZONE	B/COM	C	D	E	F	G	H	I	J	GENERAL INFORMATION
1	4605	4680	4751	4841	4991	5138	5288	5434	5584	MATERIAL: -
2	4719	4794	4865	4955	5105	5252	5402	5548	5698	MOIS. BARR: Included
3	4832	4907	4978	5068	5218	5365	5515	5661	5811	
4	4946	5021	5092	5182	5332	5479	5629	5775	5925	

Urethane arm caps are available in black, sable or dove. The glider range from forward point to rear point is 41". A 7" clearance is required when placed against a wall.

32651LG22 GLIDER, 22" SEAT, UPH ARM, URETHANE CAP, LOCKING MECHANISM

W: 29.5" D: 30" H: 42" SW: 22" SD: 19.5" SH: 18.5" AH: 24.75" WT: 61 lb COM: 3.75 yd WT CAP: 350 lb

ZONE	B/COM	C	D	E	F	G	H	I	J	GENERAL INFORMATION
1	4757	4832	4903	4993	5143	5290	5440	5586	5736	MATERIAL: -
2	4874	4949	5020	5110	5260	5407	5557	5703	5853	MOIS. BARR: Included
3	4992	5067	5138	5228	5378	5525	5675	5821	5971	
4	5109	5184	5255	5345	5495	5642	5792	5938	6088	

Urethane arm caps are available in black, sable or dove. The glider range from forward point to rear point is 41". A 7" clearance is required when placed against a wall.

32651LG24 GLIDER, 24" SEAT, UPH ARM, URETHANE CAP, LOCKING MECHANISM

W: 31.5" D: 30" H: 42" SW: 24" SD: 19.5" SH: 18.5" AH: 24.75" WT: 64 lb COM: 3.75 yd WT CAP: 350 lb

ZONE	B/COM	C	D	E	F	G	H	I	J	GENERAL INFORMATION
1	4899	4974	5045	5135	5285	5432	5582	5728	5878	MATERIAL: -
2	5020	5095	5166	5256	5406	5553	5703	5849	5999	MOIS. BARR: Included
3	5141	5216	5287	5377	5527	5674	5824	5970	6120	
4	5262	5337	5408	5498	5648	5795	5945	6091	6241	

Urethane arm caps are available in black, sable or dove. The glider range from forward point to rear point is 41". A 7" clearance is required when placed against a wall.

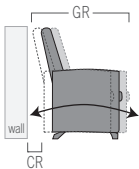

GR- Glider range from forward point to rear point is 41"

CR- Clearance required when placed against a wall is 7"

Specify:

- Product Number
- Urethane Cap Color
- Fabric Vendor, Pattern and Color

See pages 16 & 17 for material and finish options.

Capital Sleep Chairs



32841 SLEEP CHAIR

W: 30" D: 33.5" H: 33.25" SW: 24" SD: 21" SH: 18" AH: 25" WT: 110 lb COM: 5.25 yd WT CAP: 400 lb

ZONE	B/COM	C	D	E	F	G	H	I	J	GENERAL INFORMATION
1	6243	6348	6448	6574	6784	6989	7199	7403	7613	MATERIAL: Maple MOIS. BARR: Included
2	6397	6502	6602	6728	6938	7143	7353	7557	7767	
3	6551	6656	6756	6882	7092	7297	7507	7711	7921	
4	6705	6810	6910	7036	7246	7451	7661	7865	8075	



32W841 SLEEP CHAIR, WIDE

W: 36" D: 33.5" H: 33.25" SW: 30" SD: 21" SH: 18" AH: 25" WT: 128 lb COM: 6 yd WT CAP: 400 lb

ZONE	B/COM	C	D	E	F	G	H	I	J	GENERAL INFORMATION
1	6745	6865	6979	7123	7363	7597	7837	8071	8311	MATERIAL: Maple MOIS. BARR: Included
2	6911	7031	7145	7289	7529	7763	8003	8237	8477	
3	7077	7197	7311	7455	7695	7929	8169	8403	8643	
4	7244	7364	7478	7622	7862	8096	8336	8570	8810	



32841U SLEEP CHAIR, URETHANE CAP

W: 30" D: 33.5" H: 33.25" SW: 24" SD: 21" SH: 18" AH: 25" WT: 110 lb COM: 5.25 yd WT CAP: 400 lb

ZONE	B/COM	C	D	E	F	G	H	I	J	GENERAL INFORMATION
1	6578	6683	6783	6909	7119	7324	7534	7738	7948	MATERIAL: Maple MOIS. BARR: Included
2	6740	6845	6945	7071	7281	7486	7696	7900	8110	
3	6903	7008	7108	7234	7444	7649	7859	8063	8273	
4	7065	7170	7270	7396	7606	7811	8021	8225	8435	

Urethane arm caps are available in black, sable or dove.



32W841U SLEEP CHAIR, WIDE, URETHANE CAP

W: 36" D: 33.5" H: 33.25" SW: 30" SD: 21" SH: 18" AH: 25" WT: 128 lb COM: 6 yd WT CAP: 400 lb

ZONE	B/COM	C	D	E	F	G	H	I	J	GENERAL INFORMATION
1	7080	7200	7314	7458	7698	7932	8172	8406	8646	MATERIAL: Maple MOIS. BARR: Included
2	7255	7375	7489	7633	7873	8107	8347	8581	8821	
3	7429	7549	7663	7807	8047	8281	8521	8755	8995	
4	7604	7724	7838	7982	8222	8456	8696	8930	9170	

Urethane arm caps are available in black, sable or dove.

Accessories

32800-LC CASTERS

\$508 WT: 5 lb

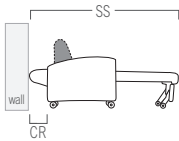

SS- Sleep surface 74"

CR- Clearance required to open sleep surface when placed against a wall is 10"

Specify:

- Product Number
- Wood Finish
- Urethane Cap Color
- Fabric Vendor, Pattern and Color

See pages 16 & 17 for material and finish options.



53411WB22 CHAIR, 22" SEAT, WOOD ARM, WOOD CAP

W: 27" D: 27.5" H: 32.5" SW: 22" SD: 20" SH: 18" AH: 25" WT: 41 lb COM: 2 yd WT CAP: 550 lb

ZONE	B/COM	C	D	E	F	G	H	I	J	GENERAL INFORMATION
1	3037	3077	3115	3163	3243	3321	3401	3479	3559	MATERIAL: Maple
2	3112	3152	3190	3238	3318	3396	3476	3554	3634	MOIS. BARR: Included
3	3187	3227	3265	3313	3393	3471	3551	3629	3709	
4	3262	3302	3340	3388	3468	3546	3626	3704	3784	

53411WB30 CHAIR, 30" SEAT, WOOD ARM, WOOD CAP

W: 35" D: 27.5" H: 32.5" SW: 30" SD: 20" SH: 18" AH: 25" WT: 54 lb COM: 2.75 yd WT CAP: 750 lb

ZONE	B/COM	C	D	E	F	G	H	I	J	GENERAL INFORMATION
1	4020	4075	4127	4193	4303	4411	4521	4628	4738	MATERIAL: Maple
2	4119	4174	4226	4292	4402	4510	4620	4727	4837	MOIS. BARR: Included
3	4219	4274	4326	4392	4502	4610	4720	4827	4937	
4	4318	4373	4425	4491	4601	4709	4819	4926	5036	

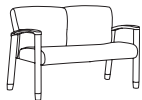

53411WB40 LOVESEAT, 40" SEAT, WOOD ARM, WOOD CAP

W: 45" D: 27.5" H: 32.5" SW: 40" SD: 20" SH: 18" AH: 25" WT: 64 lb COM: 2.75 yd WT CAP: 750 lb

ZONE	B/COM	C	D	E	F	G	H	I	J	GENERAL INFORMATION
1	4582	4637	4689	4755	4865	4973	5083	5190	5300	MATERIAL: Maple
2	4695	4750	4802	4868	4978	5086	5196	5303	5413	MOIS. BARR: Included
3	4809	4864	4916	4982	5092	5200	5310	5417	5527	
4	4922	4977	5029	5095	5205	5313	5423	5530	5640	



53410-2TW 2 SEAT TANDEM, WOOD ARM, WOOD CAP

W: 52.25" D: 27.5" H: 32.5" SW: 22" SD: 20" SH: 18" AH: 25" WT: 77 lb COM: 3.5 yd WT CAP: 550 lb

ZONE	B/COM	C	D	E	F	G	H	I	J	GENERAL INFORMATION
1	5506	5576	5643	5727	5867	6003	6143	6280	6420	MATERIAL: Maple
2	5642	5712	5779	5863	6003	6139	6279	6416	6556	MOIS. BARR: Included
3	5778	5848	5915	5999	6139	6275	6415	6552	6692	
4	5915	5985	6052	6136	6276	6412	6552	6689	6829	



53410-3TW 3 SEAT TANDEM, WOOD ARM, WOOD CAP

W: 77" D: 27.5" H: 32.5" SW: 22" SD: 20" SH: 18" AH: 25" WT: 118 lb COM: 5 yd WT CAP: 550 lb

ZONE	B/COM	C	D	E	F	G	H	I	J	GENERAL INFORMATION
1	7805	7905	8000	8120	8320	8515	8715	8910	9110	MATERIAL: Maple
2	7998	8098	8193	8313	8513	8708	8908	9103	9303	MOIS. BARR: Included
3	8191	8291	8386	8506	8706	8901	9101	9296	9496	
4	8384	8484	8579	8699	8899	9094	9294	9489	9689	

Specify:

- Product Number
- Wood Finish
- Fabric Vendor, Pattern and Color

See pages 16 & 17 for material and finish options.



53411UB22 CHAIR, 22" SEAT, WOOD ARM, URETHANE CAP

W: 27"	D: 27.5"	H: 32.5"	SW: 22"	SD: 20"	SH: 18"	AH: 25"	WT: 41 lb	COM: 2 yd	WT CAP: 550 lb	
ZONE	B/COM	C	D	E	F	G	H	I	J	GENERAL INFORMATION
1	3037	3077	3115	3163	3243	3321	3401	3479	3559	MATERIAL: Maple MOIS. BARR: Included
2	3112	3152	3190	3238	3318	3396	3476	3554	3634	
3	3187	3227	3265	3313	3393	3471	3551	3629	3709	
4	3262	3302	3340	3388	3468	3546	3626	3704	3784	

Urethane arm caps are available in black, sable or dove.

53411UB30 CHAIR, 30" SEAT, WOOD ARM, URETHANE CAP

W: 35"	D: 27.5"	H: 32.5"	SW: 30"	SD: 20"	SH: 18"	AH: 25"	WT: 54 lb	COM: 2.75 yd	WT CAP: 750 lb	
ZONE	B/COM	C	D	E	F	G	H	I	J	GENERAL INFORMATION
1	4020	4075	4127	4193	4303	4411	4521	4628	4738	MATERIAL: Maple MOIS. BARR: Included
2	4119	4174	4226	4292	4402	4510	4620	4727	4837	
3	4219	4274	4326	4392	4502	4610	4720	4827	4937	
4	4318	4373	4425	4491	4601	4709	4819	4926	5036	

Urethane arm caps are available in black, sable or dove.

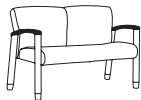

53411UB40 LOVESEAT, 40" SEAT, WOOD ARM, URETHANE CAP

W: 45"	D: 27.5"	H: 32.5"	SW: 40"	SD: 20"	SH: 18"	AH: 25"	WT: 67 lb	COM: 2.75 yd	WT CAP: 750 lb	
ZONE	B/COM	C	D	E	F	G	H	I	J	GENERAL INFORMATION
1	4582	4637	4689	4755	4865	4973	5083	5190	5300	MATERIAL: Maple MOIS. BARR: Included
2	4695	4750	4802	4868	4978	5086	5196	5303	5413	
3	4809	4864	4916	4982	5092	5200	5310	5417	5527	
4	4922	4977	5029	5095	5205	5313	5423	5530	5640	

Urethane arm caps are available in black, sable, dove or dove.



53410-2TU 2 SEAT TANDEM, WOOD ARM, URETHANE CAP

W: 52.25"	D: 27.5"	H: 32.5"	SW: 22"	SD: 20"	SH: 18"	AH: 25"	WT: 81.5 lb	COM: 3.5 yd	WT CAP: 550 lb	
ZONE	B/COM	C	D	E	F	G	H	I	J	GENERAL INFORMATION
1	5506	5576	5643	5727	5867	6003	6143	6280	6420	MATERIAL: Maple MOIS. BARR: Included
2	5642	5712	5779	5863	6003	6139	6279	6416	6556	
3	5778	5848	5915	5999	6139	6275	6415	6552	6692	
4	5915	5985	6052	6136	6276	6412	6552	6689	6829	

Urethane arm caps are available in black, sable, dove or dove.



53410-3TU 3 SEAT TANDEM, WOOD ARM, URETHANE CAP

W: 77"	D: 27.5"	H: 32.5"	SW: 22"	SD: 20"	SH: 18"	AH: 25"	WT: 124 lb	COM: 5 yd	WT CAP: 550 lb	
ZONE	B/COM	C	D	E	F	G	H	I	J	GENERAL INFORMATION
1	7805	7905	8000	8120	8320	8515	8715	8910	9110	MATERIAL: Maple MOIS. BARR: Included
2	7998	8098	8193	8313	8513	8708	8908	9103	9303	
3	8191	8291	8386	8506	8706	8901	9101	9296	9496	
4	8384	8484	8579	8699	8899	9094	9294	9489	9689	

Urethane arm caps are available in black, sable or dove.

Specify:

- Product Number
- Wood Finish
- Urethane Cap Color
- Fabric Vendor, Pattern and Color

See pages 16 & 17 for material and finish options.

Cove Patient Chairs



53471WB22 PATIENT CHAIR, 22" SEAT, WOOD ARM, WOOD CAP

W: 27" D: 30.5" H: 41" SW: 22" SD: 20" SH: 18" AH: 25" WT: 45 lb COM: 2.25 yd WT CAP: 550 lb

ZONE	B/COM	C	D	E	F	G	H	I	J	GENERAL INFORMATION
1	3311	3356	3399	3453	3543	3631	3721	3808	3898	MATERIAL: Maple MOIS. BARR: Included
2	3393	3438	3481	3535	3625	3713	3803	3890	3980	
3	3475	3520	3563	3617	3707	3795	3885	3972	4062	
4	3557	3602	3645	3699	3789	3877	3967	4054	4144	



53471WB30 PATIENT CHAIR, 30" SEAT, WOOD ARM, WOOD CAP

W: 35" D: 30.5" H: 41" SW: 30" SD: 20" SH: 18" AH: 25" WT: 59 lb COM: 3.25 yd WT CAP: 750 lb

ZONE	B/COM	C	D	E	F	G	H	I	J	GENERAL INFORMATION
1	4320	4385	4447	4525	4655	4782	4912	5038	5168	MATERIAL: Maple MOIS. BARR: Included
2	4427	4492	4554	4632	4762	4889	5019	5145	5275	
3	4533	4598	4660	4738	4868	4995	5125	5251	5381	
4	4640	4705	4767	4845	4975	5102	5232	5358	5488	



53471UB22 PATIENT CHAIR, 22" SEAT, WOOD ARM, URETHANE CAP

W: 27" D: 30.5" H: 41" SW: 22" SD: 20" SH: 18" AH: 25" WT: 45 lb COM: 2.25 yd WT CAP: 550 lb

ZONE	B/COM	C	D	E	F	G	H	I	J	GENERAL INFORMATION
1	3311	3356	3399	3453	3543	3631	3721	3808	3898	MATERIAL: Maple MOIS. BARR: Included
2	3393	3438	3481	3535	3625	3713	3803	3890	3980	
3	3475	3520	3563	3617	3707	3795	3885	3972	4062	
4	3557	3602	3645	3699	3789	3877	3967	4054	4144	

Urethane arm caps are available in black, sable or dove.



53471UB30 PATIENT CHAIR, 30" SEAT, WOOD ARM, URETHANE CAP

W: 35" D: 30.5" H: 41" SW: 30" SD: 20" SH: 18" AH: 25" WT: 59 lb COM: 3.25 yd WT CAP: 750 lb

ZONE	B/COM	C	D	E	F	G	H	I	J	GENERAL INFORMATION
1	4320	4385	4447	4525	4655	4782	4912	5038	5168	MATERIAL: Maple MOIS. BARR: Included
2	4427	4492	4554	4632	4762	4889	5019	5145	5275	
3	4533	4598	4660	4738	4868	4995	5125	5251	5381	
4	4640	4705	4767	4845	4975	5102	5232	5358	5488	

Urethane arm caps are available in black, sable or dove.

Specify:

- Product Number
- Wood Finish
- Urethane Cap Color
- Fabric Vendor, Pattern and Color

See pages 16 & 17 for material and finish options.

Cove Modular Seats



53411B22-M 1 SEAT, 22" SEAT, MODULAR

W: - D: 27.5" H: 32.5" SW: 22" SD: 20" SH: 18" AH: - WT: 29 lb COM: 2 yd WT CAP: 550 lb

ZONE	B/COM	C	D	E	F	G	H	I	J	GENERAL INFORMATION
1	1419	1459	1497	1545	1625	1703	1783	1861	1941	MATERIAL: -
2	1454	1494	1532	1580	1660	1738	1818	1896	19760	MOIS. BARR: Included
3	1488	1528	1566	1614	1694	1772	1852	1930	2010	
4	1523	1563	1601	1649	1729	1807	1887	1965	2045	

Shaded portion of the illustration indicates the product being described. Modular seating orders must include a layout to ensure proper configuration. Arms MUST be ordered separately from seat and back cushions - please note the product descriptions on this page.

53411B30-M 1 SEAT, 30" SEAT, MODULAR

W: - D: 27.5" H: 32.5" SW: 30" SD: 20" SH: 18" AH: - WT: 42 lb COM: 2.75 yd WT CAP: 750 lb

ZONE	B/COM	C	D	E	F	G	H	I	J	GENERAL INFORMATION
1	2450	2505	2557	2623	2733	2841	2951	3058	3168	MATERIAL: -
2	2510	2565	2617	2683	2793	2901	3011	3118	3228	MOIS. BARR: Included
3	2570	2625	2677	2743	2853	2961	3071	3178	3288	
4	2630	2685	2737	2803	2913	3021	3131	3238	3348	

Shaded portion of the illustration indicates the product being described. Modular seating orders must include a layout to ensure proper configuration. Arms MUST be ordered separately from seat and back cushions - please note the product descriptions on this page.

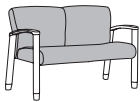

53411B40-M 1 LOVESEAT, 40" SEAT, MODULAR

W: - D: 27.5" H: 32.5" SW: 40" SD: 20" SH: 18" AH: - WT: 52 lb COM: 2.75 yd WT CAP: 750 lb

ZONE	B/COM	C	D	E	F	G	H	I	J	GENERAL INFORMATION
1	3040	3095	3147	3213	3323	3431	3541	3648	3758	MATERIAL: -
2	3115	3170	3222	3288	3398	3506	3616	3723	3833	MOIS. BARR: Included
3	3190	3245	3297	3363	3473	3581	3691	3798	3908	
4	3265	3320	3372	3438	3548	3656	3766	3873	3983	

Shaded portion of the illustration indicates the product being described. Modular seating orders must include a layout to ensure proper configuration. Arms MUST be ordered separately from seat and back cushions - please note the product descriptions on this page.

Specify:

- Product Number
- Fabric Vendor, Pattern and Color
- Room Layout

See pages 16 & 17 for material and finish options.

Cove Modular Arms



53410WB-LA LEFT ARM, WOOD, WOOD CAP, MODULAR

W: 2.75" D: 25.75" H: 25" WT: 6 lb

Zone	1	2	3	4
	880	902	924	946

GENERAL INFORMATION

MATERIAL: Maple
MOIS BARR: -

Shaded portion of the illustration indicates the product being described. Modular seating orders must include a layout to ensure proper configuration. Seat and back cushions MUST be ordered separately from arms - please note the product descriptions on this page.

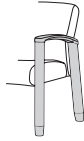

53410WB-RA RIGHT ARM, WOOD, WOOD CAP, MODULAR

W: 2.75" D: 25.75" H: 25" WT: 6 lb

Zone	1	2	3	4
	880	902	924	946

GENERAL INFORMATION

MATERIAL: Maple
MOIS BARR: -

Shaded portion of the illustration indicates the product being described. Modular seating orders must include a layout to ensure proper configuration. Seat and back cushions MUST be ordered separately from arms - please note the product descriptions on this page.

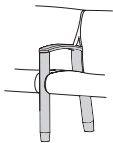

53410WB-CA CENTER ARM, WOOD, WOOD CAP, MODULAR

W: 2.75" D: 25.75" H: 25" WT: 6 lb

Zone	1	2	3	4
	880	902	924	946

GENERAL INFORMATION

MATERIAL: Maple
MOIS BARR: -

Shaded portion of the illustration indicates the product being described. Modular seating orders must include a layout to ensure proper configuration. Seat and back cushions MUST be ordered separately from arms - please note the product descriptions on this page.



53410UB-LA LEFT ARM, WOOD, URETHANE CAP, MODULAR

W: 2.75" D: 25.75" H: 25" WT: 7.5 lb

Zone	1	2	3	4
	880	902	924	946

GENERAL INFORMATION

MATERIAL: Maple
MOIS BARR: -

Shaded portion of the illustration indicates the product being described. Modular seating orders must include a layout to ensure proper configuration. Seat and back cushions MUST be ordered separately from arms - please note the product descriptions on this page. Urethane arm caps are available in black, sable or dove.



53410UB-RA RIGHT ARM, WOOD, URETHANE CAP, MODULAR

W: 2.75" D: 25.75" H: 25" WT: 7.5 lb

Zone	1	2	3	4
	880	902	924	946

GENERAL INFORMATION

MATERIAL: Maple
MOIS BARR: -

Shaded portion of the illustration indicates the product being described. Modular seating orders must include a layout to ensure proper configuration. Seat and back cushions MUST be ordered separately from arms - please note the product descriptions on this page. Urethane arm caps are available in black, sable or dove.

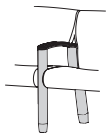

53410UB-CA CENTER ARM, WOOD, URETHANE CAP, MODULAR

W: 2.75" D: 25.75" H: 25" WT: 7.5 lb

Zone	1	2	3	4
	880	902	924	946

GENERAL INFORMATION

MATERIAL: Maple
MOIS BARR: -

Shaded portion of the illustration indicates the product being described. Modular seating orders must include a layout to ensure proper configuration. Seat and back cushions MUST be ordered separately from arms - please note the product descriptions on this page. Urethane arm caps are available in black, sable or dove.

Specify:

- Product Number
- Wood Finish
- Urethane Cap Color
- Room Layout

See pages 16 & 17 for material and finish options.

Cove Lounge



53L411W CHAIR, WOOD ARM, WOOD CAP

W: 30" D: 32.5" H: 32.5" SW: 24" SD: 21" SH: 18.5" AH: 24" WT: 62 lb COM: 2.75 yd WT CAP: 550 lb

ZONE	B/COM	C	D	E	F	G	H	I	J	GENERAL INFORMATION
1	3915	3970	4022	4088	4198	4306	4416	4523	4633	MATERIAL: Maple MOIS. BARR: Included
2	4012	4067	4119	4185	4295	4403	4513	4620	4730	
3	4109	4164	4216	4282	4392	4500	4610	4717	4827	
4	4205	4260	4312	4378	4488	4596	4706	4813	4923	



53L412W LOVESEAT, WOOD ARM, WOOD CAP

W: 54" D: 32.5" H: 32.5" SW: 48" SD: 21" SH: 18.5" AH: 24" WT: 95 lb COM: 4.5 yd WT CAP: 650 lb

ZONE	B/COM	C	D	E	F	G	H	I	J	GENERAL INFORMATION
1	5742	5832	5918	6026	6206	6381	6561	6737	6917	MATERIAL: Maple MOIS. BARR: Included
2	5884	5974	6060	6168	6348	6523	6703	6879	7059	
3	6026	6116	6202	6310	6490	6665	6845	7021	7201	
4	6167	6257	6343	6451	6631	6806	6986	7162	7342	

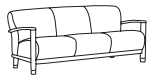

53L413W SOFA, WOOD ARM, WOOD CAP

W: 76" D: 32.5" H: 32.5" SW: 72" SD: 21" SH: 18.5" AH: 24" WT: 128 lb COM: 6.25 yd WT CAP: 750 lb

ZONE	B/COM	C	D	E	F	G	H	I	J	GENERAL INFORMATION
1	7085	7210	7329	7479	7729	7973	8223	8466	8716	MATERIAL: Maple MOIS. BARR: Included
2	7260	7385	7504	7654	7904	8148	8398	8641	8891	
3	7434	7559	7678	7828	8078	8322	8572	8815	9065	
4	7609	7734	7853	8003	8253	8497	8747	8990	9240	



53L411U CHAIR, WOOD ARM, URETHANE CAP

W: 30" D: 32.5" H: 32.5" SW: 24" SD: 21" SH: 18.5" AH: 24" WT: 62 lb COM: 2.75 yd WT CAP: 550 lb

ZONE	B/COM	C	D	E	F	G	H	I	J	GENERAL INFORMATION
1	3915	3970	4022	4088	4198	4306	4416	4523	4633	MATERIAL: Maple MOIS. BARR: Included
2	4012	4067	4119	4185	4295	4403	4513	4620	4730	
3	4109	4164	4216	4282	4392	4500	4610	4717	4827	
4	4205	4260	4312	4378	4488	4596	4706	4813	4923	

Urethane arm caps are available in black, sable or dove.



53L412U LOVESEAT, WOOD ARM, URETHANE CAP

W: 54" D: 32.5" H: 32.5" SW: 48" SD: 21" SH: 18.5" AH: 24" WT: 95 lb COM: 4.5 yd WT CAP: 650 lb

ZONE	B/COM	C	D	E	F	G	H	I	J	GENERAL INFORMATION
1	5742	5832	5918	6026	6206	6381	6561	6737	6917	MATERIAL: Maple MOIS. BARR: Included
2	5884	5974	6060	6168	6348	6523	6703	6879	7059	
3	6026	6116	6202	6310	6490	6665	6845	7021	7201	
4	6167	6257	6343	6451	6631	6806	6986	7162	7342	

Urethane arm caps are available in black, sable or dove.

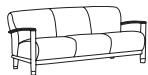

53L413U SOFA, WOOD ARM, URETHANE CAP

W: 76" D: 32.5" H: 32.5" SW: 72" SD: 21" SH: 18.5" AH: 24" WT: 128 lb COM: 6.25 yd WT CAP: 750 lb

ZONE	B/COM	C	D	E	F	G	H	I	J	GENERAL INFORMATION
1	7085	7210	7329	7479	7729	7973	8223	8466	8716	MATERIAL: Maple MOIS. BARR: Included
2	7260	7385	7504	7654	7904	8148	8398	8641	8891	
3	7434	7559	7678	7828	8078	8322	8572	8815	9065	
4	7609	7734	7853	8003	8253	8497	8747	8990	9240	

Urethane arm caps are available in black, sable or dove.

Specify:

- Product Number
- Wood Finish
- Urethane Cap Color
- Fabric Vendor, Pattern and Color

See pages 16 & 17 for material and finish options.

Cove Recliners

ARM CAP MODELS



Specify finish.



Specify black, sable or dove.



Specify solid surface color.

ARM OPTIONS

Transfer Arm (53900-TA) \$903



Specify right, left or both (as facing).

Transfer arm is only available with the straight back option.

BACK OPTIONS



Standard Back



Straight Back



Metal Pushbar (53900-MPB) \$389

Black or silver.



Pushbar Cover (53900-PBC) \$198

Specify fabric.



Back Edge Wall Guard \$63

FEET OPTIONS

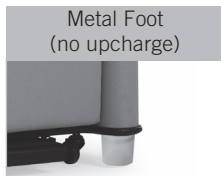

Metal Foot (no upcharge)

Black or silver.



Wood Foot (no upcharge)

TABLES



Full-flip Table (53900-FT)

Laminate* \$565
Thermoform \$565
Solid Surface \$1129

Available right side only (as facing). Full-flip tables cannot be used with a foley-bag hook. Full flip table is 13.5"W x 19"D.



Half-flip Table (53900-FTP)

Laminate* \$565
Thermoform \$565
Solid Surface \$1129

Available right side only (as facing). Half-flip table is 13.5"W x 13.25"D.



Fold-down Table (53900-FDT)

Laminate** \$1217
Thermoform \$1217
Solid Surface \$2433

Specify right or left (as facing).
Fold-down table is 12 5/8"W x 19 1/8"D.



*Full and half-flip tables are available with a vinyl edge, specify black, white, brown, gray or almond.

**Fold-down table, wood finished edge is standard and only option.

ACCESSORIES



Footrest (53900-FR) \$375



Standard IV-pole (53900-V1) \$398

Specify right or left (as facing). Not available on transfer arm side when specified.



Quick Release Seat (53900-QR) \$303

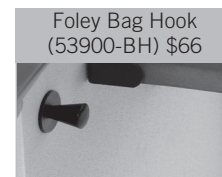

Foley Bag Hook (53900-BH) \$66

Available right side only (as facing).

Cove Patient Recliners



53981 PATIENT RECLINER

W: 29.25" D: 34.75" H: 43" SW: 21.5" SD: 20.5" SH: 19" AH: 24.75" WT: 137 lb COM: 4.75 yd WT CAP: 500 lb

ZONE	B/COM	C	D	E	F	G	H	I	J	GENERAL INFORMATION
1	6457	6552	6642	6756	6946	7132	7322	7507	7697	MATERIAL: Varies MOIS. BARR: Included
2	6617	6712	6802	6916	7106	7292	7482	7667	7857	
3	6776	6871	6961	7075	7265	7451	7641	7826	8016	
4	6936	7031	7121	7235	7425	7611	7801	7986	8176	



53W981 PATIENT RECLINER, WIDE

W: 31.25" D: 34.75" H: 43" SW: 23.5" SD: 20.5" SH: 19" AH: 24.75" WT: 145 lb COM: 5 yd WT CAP: 500 lb

ZONE	B/COM	C	D	E	F	G	H	I	J	GENERAL INFORMATION
1	7018	7118	7213	7333	7533	7728	7928	8123	8323	MATERIAL: Varies MOIS. BARR: Included
2	7191	7291	7386	7506	7706	7901	8101	8296	8496	
3	7365	7465	7560	7680	7880	8075	8275	8470	8670	
4	7538	7638	7733	7853	8053	8248	8448	8643	8843	



53X981 PATIENT RECLINER, EXTRA WIDE

W: 35.25" D: 34.75" H: 43" SW: 27.5" SD: 20.5" SH: 19" AH: 24.75" WT: 161 lb COM: 5.75 yd WT CAP: 500 lb

ZONE	B/COM	C	D	E	F	G	H	I	J	GENERAL INFORMATION
1	7720	7835	7944	8082	8312	8537	8767	8991	9221	MATERIAL: Varies MOIS. BARR: Included
2	7911	8026	8135	8273	8503	8728	8958	9182	9412	
3	8101	8216	8325	8463	8693	8918	9148	9372	9602	
4	8292	8407	8516	8654	8884	9109	9339	9563	9793	

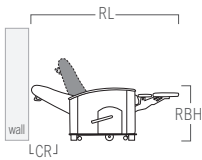

RL- Reclined length 69"

RBH- Reclined back height 31"

CR- Clearance required when placed against a wall is 24"

A 12" clearance is required from edge of chair when optional table is extended.

Specify:

- Product Number
- Wood Finish
- Urethane Cap Color
- Laminate Vendor, Pattern and Color
- Solid Surface Color
- Fabric Vendor, Pattern and Color
- Recliner Options

See pages 16 & 17 for material and finish options.

Cove Orthopedic Recliners



53H981 ORTHOPEDIC PATIENT RECLINER

W: 29.25" D: 34.75" H: 45" SW: 21.5" SD: 20.5" SH: 21" AH: 26.75" WT: 143 lb COM: 5 yd WT CAP: 500 lb

ZONE	B/COM	C	D	E	F	G	H	I	J	GENERAL INFORMATION
1	6914	7014	7109	7229	7429	7624	7824	8019	8219	MATERIAL: Varies
2	7085	7185	7280	7400	7600	7795	7995	8190	8390	MOIS. BARR: Included
3	7256	7356	7451	7571	7771	7966	8166	8361	8561	
4	7427	7527	7622	7742	7942	8137	8337	8532	8732	



53WH981 ORTHOPEDIC PATIENT RECLINER, WIDE

W: 31.25" D: 34.75" H: 45" SW: 23.5" SD: 20.5" SH: 21" AH: 26.75" WT: 151 lb COM: 5.25 yd WT CAP: 500 lb

ZONE	B/COM	C	D	E	F	G	H	I	J	GENERAL INFORMATION
1	7474	7579	7679	7805	8015	8220	8430	8634	8844	MATERIAL: Varies
2	7659	7764	7864	7990	8200	8405	8615	8819	9029	MOIS. BARR: Included
3	7844	7949	8049	8175	8385	8590	8800	9004	9214	
4	8028	8133	8233	8359	8569	8774	8984	9188	9398	



53XH981 ORTHOPEDIC PATIENT RECLINER, EXTRA WIDE

W: 35.25" D: 34.75" H: 45" SW: 27.5" SD: 20.5" SH: 21" AH: 26.75" WT: 167 lb COM: 6 yd WT CAP: 500 lb

ZONE	B/COM	C	D	E	F	G	H	I	J	GENERAL INFORMATION
1	8206	8326	8440	8584	8824	9058	9298	9532	9772	MATERIAL: Varies
2	8409	8529	8643	8787	9027	9261	9501	9735	9975	MOIS. BARR: Included
3	8612	8732	8846	8990	9230	9464	9704	9938	10178	
4	8814	8934	9048	9192	9432	9666	9906	10140	10380	

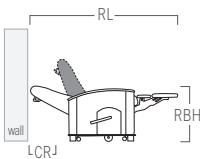

RL- Reclined length 73"

RBH- Reclined back height 32"

CR- Clearance required when placed against a wall is 24"

A 12" clearance is required from edge of chair when optional table is extended.

Specify:

- Product Number
- Wood Finish
- Urethane Cap Color
- Laminate Vendor, Pattern and Color
- Solid Surface Color
- Fabric Vendor, Pattern and Color
- Recliner Options

See pages 16 & 17 for material and finish options.

Cove Sleep Recliners



53981S SLEEP RECLINER

W: 29.25" D: 34.75" H: 43" SW: 21.5" SD: 20.5" SH: 19" AH: 24.75" WT: 139 lb COM: 4.75 yd WT CAP: 500 lb

ZONE	B/COM	C	D	E	F	G	H	I	J	GENERAL INFORMATION
1	7139	7234	7324	7438	7628	7814	8004	8189	8379	MATERIAL: Varies MOIS. BARR: Included
2	7316	7411	7501	7615	7805	7991	8181	8366	8556	
3	7492	7587	7677	7791	7981	8167	8357	8542	8732	
4	7669	7764	7854	7968	8158	8344	8534	8719	8909	



53W981S SLEEP RECLINER, WIDE

W: 31.25" D: 34.75" H: 43" SW: 23.5" SD: 20.5" SH: 19" AH: 24.75" WT: 147 lb COM: 5 yd WT CAP: 500 lb

ZONE	B/COM	C	D	E	F	G	H	I	J	GENERAL INFORMATION
1	7698	7798	7893	8013	8213	8408	8608	8803	9003	MATERIAL: Varies MOIS. BARR: Included
2	7888	7988	8083	8203	8403	8598	8798	8993	9193	
3	8079	8179	8274	8394	8594	8789	8989	9184	9384	
4	8269	8369	8464	8584	8784	8979	9179	9374	9574	

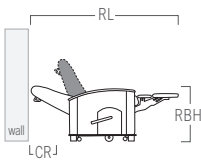

RL- Reclined length 73"

RBH- Reclined back height 32"

CR- Clearance required when placed against a wall is 24"

A 12" clearance is required from edge of chair when optional table is extended.

Specify:

- Product Number
- Wood Finish
- Urethane Cap Color
- Laminate Vendor, Pattern and Color
- Solid Surface Color
- Fabric Vendor, Pattern and Color
- Recliner Options

See pages 16 & 17 for material and finish options.

Cove Orthopedic/Sleep Recliners



53H981S ORTHOPEDIC SLEEP RECLINER

W: 29.25" D: 34.75" H: 45" SW: 21.5" SD: 20.5" SH: 21" AH: 26.75" WT: 148 lb COM: 5 yd WT CAP: 500 lb

ZONE	B/COM	C	D	E	F	G	H	I	J	GENERAL INFORMATION
1	7591	7691	7786	7906	8106	8301	8501	8696	8896	MATERIAL: Varies MOIS. BARR: Included
2	7779	7879	7974	8094	8294	8489	8689	8884	9084	
3	7967	8067	8162	8282	8482	8677	8877	9072	9272	
4	8154	8254	8349	8469	8669	8864	9064	9259	9459	



53WH981S ORTHOPEDIC SLEEP RECLINER, WIDE

W: 31.25" D: 34.75" H: 45" SW: 23.5" SD: 20.5" SH: 21" AH: 26.75" WT: 156 lb COM: 5.25 yd WT CAP: 500 lb

ZONE	B/COM	C	D	E	F	G	H	I	J	GENERAL INFORMATION
1	8152	8257	8357	8483	8693	8898	9108	9312	9522	MATERIAL: Varies MOIS. BARR: Included
2	8354	8459	8559	8685	8895	9100	9310	9514	9724	
3	8555	8660	8760	8886	9096	9301	9511	9715	9925	
4	8757	8862	8962	9088	9298	9503	9713	9917	10127	

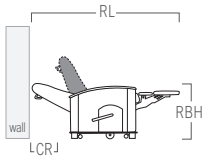

RL- Reclined length 73"

RBH- Reclined back height 32"

CR- Clearance required when placed against a wall is 24"

A 12" clearance is required from edge of chair when optional table is extended.

Specify:

- Product Number
- Wood Finish
- Urethane Cap Color
- Laminate Vendor, Pattern and Color
- Solid Surface Color
- Fabric Vendor, Pattern and Color
- Recliner Options

See pages 16 & 17 for material and finish options.

Cove Trendelenburg Recliners



53981T TRENDELENBURG RECLINER

W: 29.25" D: 34.75" H: 43" SW: 21.5" SD: 20.5" SH: 19" AH: 24.75" WT: 145 lb COM: 4.75 yd WT CAP: 500 lb

ZONE	B/COM	C	D	E	F	G	H	I	J	GENERAL INFORMATION
1	7353	7448	7538	7652	7842	8028	8218	8403	8593	MATERIAL: Varies MOIS. BARR: Included
2	7535	7630	7720	7834	8024	8210	8400	8585	8775	
3	7717	7812	7902	8016	8206	8392	8582	8767	8957	
4	7899	7994	8084	8198	8388	8574	8764	8949	9139	



53W981T TRENDELENBURG RECLINER, WIDE

W: 31.25" D: 34.75" H: 43" SW: 23.5" SD: 20.5" SH: 19" AH: 24.75" WT: 153 lb COM: 5 yd WT CAP: 500 lb

ZONE	B/COM	C	D	E	F	G	H	I	J	GENERAL INFORMATION
1	7916	8016	8111	8231	8431	8626	8826	9021	9221	MATERIAL: Varies MOIS. BARR: Included
2	8112	8212	8307	8427	8627	8822	9022	9217	9417	
3	8308	8408	8503	8623	8823	9018	9218	9413	9613	
4	8504	8604	8699	8819	9019	9214	9414	9609	9809	

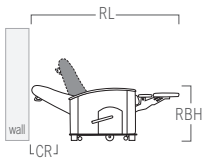

RL- Reclined length 73"

RBH- Reclined back height 27"

CR- Clearance required when placed against a wall is 21"

A 12" clearance is required from edge of chair when optional table is extended.

Specify:

- Product Number
- Wood Finish
- Urethane Cap Color
- Laminate Vendor, Pattern and Color
- Solid Surface Color
- Fabric Vendor, Pattern and Color
- Recliner Options

See pages 16 & 17 for material and finish options.

Dune Occasional Tables

LEG OPTIONS

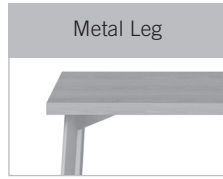

Specify metal finish.

FREESTANDING TABLE EDGE OPTIONS

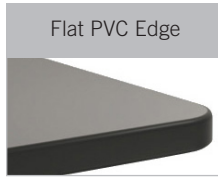

Available in 7 colors to match metal finishes.

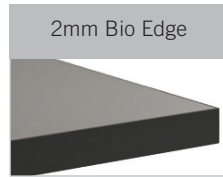

Available in 7 colors to match metal finishes.

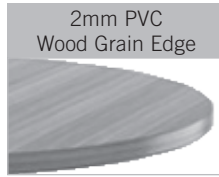

Available in 9 wood grain colors to match standard laminates.

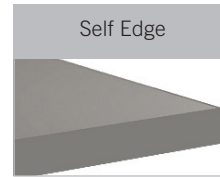

Specify laminate color.

Dune Occasional Tables



225241820RE RECTANGULAR END TABLE, METAL, 24D 18W 20H

W: 18" D: 24" H: 20" WT: 23 lb

GENERAL INFORMATION

TOP MATERIAL: Laminate
BASE MATERIAL: Metal

Zone	1	2	3	4
	1382	1417	1451	1486

Table ships unassembled.

225242420SQ SQUARE END TABLE, METAL, 24D 24W 20H

W: 24" D: 24" H: 20" WT: 26 lb

GENERAL INFORMATION

TOP MATERIAL: Laminate
BASE MATERIAL: Metal

Zone	1	2	3	4
	1382	1417	1451	1486

Table ships unassembled.



225242420RD ROUND END TABLE, METAL, 24D 24W 20H

W: 24" D: 24" H: 20" WT: 26 lb

GENERAL INFORMATION

TOP MATERIAL: Laminate
BASE MATERIAL: Metal

Zone	1	2	3	4
	1382	1417	1451	1486

Table ships unassembled.

225244816RE RECTANGULAR COFFEE TABLE, METAL, 24D 48W 16H

W: 48" D: 24" H: 16" WT: 34 lb

GENERAL INFORMATION

TOP MATERIAL: Laminate
BASE MATERIAL: Metal

Zone	1	2	3	4
	1621	1662	1702	1743

Table ships unassembled.



225484816SQ SQUARE COFFEE TABLE, METAL, 48D 48W 16H

W: 48" D: 48" H: 16" WT: 54 lb

GENERAL INFORMATION

TOP MATERIAL: Laminate
BASE MATERIAL: Metal

Zone	1	2	3	4
	2402	2462	2522	2582

Table ships unassembled.

225484816RD ROUND COFFEE TABLE, METAL, 48D 48W 16H

W: 48" D: 48" H: 16" WT: 54 lb

GENERAL INFORMATION

TOP MATERIAL: Laminate
BASE MATERIAL: Metal

Zone	1	2	3	4
	2283	2340	2397	2454

Table ships unassembled.

Specify:

- Product Number
- Metal Finish
- Edge Style & Finish
- Laminate Vendor, Name & Number

See pages 16 & 17 for material and finish options.

Dune Occasional Tables



224241820RE RECTANGULAR END TABLE, WOOD, 24D 18W 20H

W: 18" D: 24" H: 20" WT: 21 lb

Zone	1	2	3	4
	1862	1909	1955	2002

Table ships unassembled.

GENERAL INFORMATION

TOP MATERIAL: Laminate
BASE MATERIAL: Wood and Metal



224242420SQ SQUARE END TABLE, WOOD, 24D 24W 20H

W: 24" D: 24" H: 20" WT: 24 lb

Zone	1	2	3	4
	1862	1909	1955	2002

Table ships unassembled.

GENERAL INFORMATION

TOP MATERIAL: Laminate
BASE MATERIAL: Wood and Metal



224242420RD ROUND END TABLE, WOOD, 24D 24W 20H

W: 24" D: 24" H: 20" WT: 24 lb

Zone	1	2	3	4
	1862	1909	1955	2002

Table ships unassembled.

GENERAL INFORMATION

TOP MATERIAL: Laminate
BASE MATERIAL: Wood and Metal

224244816RE RECTANGULAR COFFEE TABLE, WOOD, 24D 48W 16H

W: 48" D: 24" H: 16" WT: 32 lb

Zone	1	2	3	4
	2102	2155	2207	2260

Table ships unassembled.

GENERAL INFORMATION

TOP MATERIAL: Laminate
BASE MATERIAL: Wood and Metal

224484816SQ SQUARE COFFEE TABLE, WOOD, 48D 48W 16H

W: 48" D: 48" H: 16" WT: 52 lb

Zone	1	2	3	4
	2883	2955	3027	3099

Table ships unassembled.

GENERAL INFORMATION

TOP MATERIAL: Laminate
BASE MATERIAL: Wood and Metal

224484816RD ROUND COFFEE TABLE, WOOD, 48D 48W 16H

W: 48" D: 48" H: 16" WT: 52 lb

Zone	1	2	3	4
	2763	2832	2901	2970

Table ships unassembled.

GENERAL INFORMATION

TOP MATERIAL: Laminate
BASE MATERIAL: Wood and Metal

Specify:

- Product Number
- Metal Finish
- Wood Finish
- Edge Style & Finish
- Laminate Vendor, Name & Number

See pages 16 & 17 for material and finish options.

ARM CAP OPTIONS

No Cap
~~DISC~~
Standard.

Solid Surface Cap
~~\$293~~
standard
~~\$440 2-Seat Tandem~~
~~\$596 3-Seat Tandem~~
Specify solid surface color.

Thermoform Cap
\$440
\$660 2-Seat Tandem
\$880 3-Seat Tandem
Specify thermoform finish.

Wood Cap
~~\$146~~
standard
~~\$219 2-Seat Tandem~~
~~\$292 3-Seat Tandem~~
Specify wood finish (Beech).

Nylon Cap
\$74
~~DISC~~
\$171 2-Seat Tandem
\$148 3-Seat Tandem
Specify nylon color. Not available on 2- and 3-seat benches.

Full Solid Surface Cap
\$307
\$459 2-Seat Tandem
\$610 3-Seat Tandem
Specify solid surface color.
Full cap available in solid surface only. Not available on benches.

ARM OPTIONS

Open Arm

Fabric Arm Insert

Not available on motion chairs.

MODULAR TABLE OPTIONS

Thermoform

Standard. Specify thermoform finish. Not available on arm insert models.

Solid Surface
\$481

Specify solid surface color. Not available on arm insert models.

ACCESSORIES

Ganging Assembly
\$182 (6650707)

One assembly required between each seat.

Tip Back Caster
\$137

Available on single seat models only.

Hale Arm Chairs



6651121 CHAIR, 21" SEAT, METAL FRAME

W: 24" D: 24.75" H: 34" SW: 21" SD: 19" SH: 18" AH: 25" WT: 35 lb COM: 2 yd WT CAP: 550 lb

ZONE	B/COM	C	D	E	F	G	H	I	J	GENERAL INFORMATION
1	1762	1802	1840	1888	1968	2046	2126	2204	2284	MATERIAL: Metal MOIS. BARR: \$24
2	1805	1845	1883	1931	2011	2089	2169	2247	2327	
3	1848	1888	1926	1974	2054	2132	2212	2290	2370	
4	1892	1932	1970	2018	2098	2176	2256	2334	2414	

6651130 CHAIR, 30" SEAT, METAL FRAME

W: 33" D: 24.75" H: 34" SW: 30" SD: 19" SH: 18" AH: 25" WT: 43 lb COM: 2.75 yd WT CAP: 750 lb

ZONE	B/COM	C	D	E	F	G	H	I	J	GENERAL INFORMATION
1	2215	2270	2322	2388	2498	2606	2716	2823	2933	MATERIAL: Metal MOIS. BARR: \$33
2	2269	2324	2376	2442	2552	2660	2770	2877	2987	
3	2324	2379	2431	2497	2607	2715	2825	2932	3042	
4	2378	2433	2485	2551	2661	2769	2879	2986	3096	

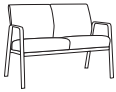

665112 LOVESEAT, METAL FRAME

W: 45" D: 24.75" H: 34" SW: 21" SD: 19" SH: 18" AH: 25" WT: 71 lb COM: 3.25 yd WT CAP: 750 lb

ZONE	B/COM	C	D	E	F	G	H	I	J	GENERAL INFORMATION
1	3340	3405	3467	3545	3675	3802	3932	4058	4188	MATERIAL: Metal MOIS. BARR: \$39
2	3422	3487	3549	3627	3757	3884	4014	4140	4270	
3	3504	3569	3631	3709	3839	3966	4096	4222	4352	
4	3587	3652	3714	3792	3922	4049	4179	4305	4435	

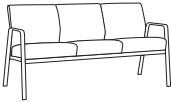

665113 SOFA, METAL FRAME

W: 66" D: 24.75" H: 34" SW: 21" SD: 19" SH: 18" AH: 25" WT: 103 lb COM: 4.75 yd WT CAP: 750 lb

ZONE	B/COM	C	D	E	F	G	H	I	J	GENERAL INFORMATION
1	4932	5027	5117	5231	5421	5607	5797	5982	6172	MATERIAL: Metal MOIS. BARR: \$57
2	5053	5148	5238	5352	5542	5728	5918	6103	6293	
3	5175	5270	5360	5474	5664	5850	6040	6225	6415	
4	5296	5391	5481	5595	5785	5971	6161	6346	6536	



66510-2T 2 SEAT TANDEM, SHORT CENTER ARMS, METAL FRAME

W: 46.5" D: 24.75" H: 34" SW: 21" SD: 19" SH: 18" AH: 25" WT: 73 lb COM: 3.25 yd WT CAP: 750 lb

ZONE	B/COM	C	D	E	F	G	H	I	J	GENERAL INFORMATION
1	3520	3585	3647	3725	3855	3982	4112	4238	4368	MATERIAL: Metal MOIS. BARR: \$39
2	3607	3672	3734	3812	3942	4069	4199	4325	4455	
3	3693	3758	3820	3898	4028	4155	4285	4411	4541	
4	3780	3845	3907	3985	4115	4242	4372	4498	4628	

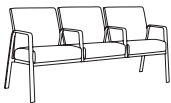

66510-3T 3 SEAT TANDEM, SHORT CENTER ARMS, METAL FRAME

W: 69" D: 24.75" H: 34" SW: 21" SD: 19" SH: 18" AH: 25" WT: 106 lb COM: 4.75 yd WT CAP: 750 lb

ZONE	B/COM	C	D	E	F	G	H	I	J	GENERAL INFORMATION
1	5284	5379	5469	5583	5773	5959	6149	6334	6524	MATERIAL: Metal MOIS. BARR: \$57
2	5414	5509	5599	5713	5903	6089	6279	6464	6654	
3	5544	5639	5729	5843	6033	6219	6409	6594	6784	
4	5675	5770	5860	5974	6164	6350	6540	6725	6915	

Specify:
 Product Number
 Fabric Vendor,
 Pattern and Color

See pages 16 & 17
 for material and finish
 options.

Hale Arm Chairs



6652121 CHAIR, 21" SEAT, ARM INSERT, METAL FRAME

W: 24"	D: 24.75"	H: 34"	SW: 21"	SD: 19"	SH: 18"	AH: 25"	WT: 37 lb	COM: 2.5 yd	WT CAP: 550 lb	
ZONE	B/COM	C	D	E	F	G	H	I	J	GENERAL INFORMATION
1	2298	2348	2396	2456	2556	2653	2753	2851	2951	MATERIAL: Metal MOIS. BARR: \$30
2	2354	2404	2452	2512	2612	2709	2809	2907	3007	
3	2411	2461	2509	2569	2669	2766	2866	2964	3064	
4	2467	2517	2565	2625	2725	2822	2922	3020	3120	

6652130 CHAIR, 30" SEAT, ARM INSERT, METAL FRAME

W: 33"	D: 24.75"	H: 34"	SW: 30"	SD: 19"	SH: 18"	AH: 25"	WT: 45 lb	COM: 2.75 yd	WT CAP: 750 lb	
ZONE	B/COM	C	D	E	F	G	H	I	J	GENERAL INFORMATION
1	2753	2808	2860	2926	3036	3144	3254	3361	3471	MATERIAL: Metal MOIS. BARR: \$33
2	2821	2876	2928	2994	3104	3212	3322	3429	3539	
3	2888	2943	2995	3061	3171	3279	3389	3496	3606	
4	2956	3011	3063	3129	3239	3347	3457	3564	3674	

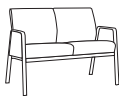

665212 LOVESEAT, ARM INSERT, METAL FRAME

W: 45"	D: 24.75"	H: 34"	SW: 21"	SD: 19"	SH: 18"	AH: 25"	WT: 73 lb	COM: 3.75 yd	WT CAP: 750 lb	
ZONE	B/COM	C	D	E	F	G	H	I	J	GENERAL INFORMATION
1	4098	4173	4244	4334	4484	4631	4781	4927	5077	MATERIAL: Metal MOIS. BARR: \$45
2	4199	4274	4345	4435	4585	4732	4882	5028	5178	
3	4300	4375	4446	4536	4686	4833	4983	5129	5279	
4	4401	4476	4547	4637	4787	4934	5084	5230	5380	

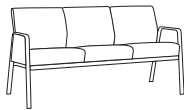

665213 SOFA, ARM INSERT, METAL FRAME

W: 66"	D: 24.75"	H: 34"	SW: 21"	SD: 19"	SH: 18"	AH: 25"	WT: 105 lb	COM: 5 yd	WT CAP: 750 lb	
ZONE	B/COM	C	D	E	F	G	H	I	J	GENERAL INFORMATION
1	5921	6021	6116	6236	6436	6631	6831	7026	7226	MATERIAL: Metal MOIS. BARR: \$60
2	6067	6167	6262	6382	6582	6777	6977	7172	7372	
3	6213	6313	6408	6528	6728	6923	7123	7318	7518	
4	6359	6459	6554	6674	6874	7069	7269	7464	7664	



66520-2T 2 SEAT TANDEM, SHORT CENTER ARMS, ARM INSERT METAL FRAME

W: 46.5"	D: 24.75"	H: 34"	SW: 21"	SD: 19"	SH: 18"	AH: 25"	WT: 76 lb	COM: 4 yd	WT CAP: 750 lb	
ZONE	B/COM	C	D	E	F	G	H	I	J	GENERAL INFORMATION
1	4285	4365	4441	4537	4697	4853	5013	5169	5329	MATERIAL: Metal MOIS. BARR: \$48
2	4391	4471	4547	4643	4803	4959	5119	5275	5435	
3	4496	4576	4652	4748	4908	5064	5224	5380	5540	
4	4602	4682	4758	4854	5014	5170	5330	5486	5646	

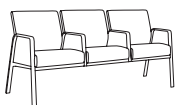

66520-3T 3 SEAT TANDEM, SHORT CENTER ARMS, ARM INSERT METAL FRAME

W: 69"	D: 24.75"	H: 34"	SW: 21"	SD: 19"	SH: 18"	AH: 25"	WT: 110 lb	COM: 5.5 yd	WT CAP: 750 lb	
ZONE	B/COM	C	D	E	F	G	H	I	J	GENERAL INFORMATION
1	6271	6381	6486	6618	6838	7052	7272	7487	7707	MATERIAL: Metal MOIS. BARR: \$66
2	6426	6536	6641	6773	6993	7207	7427	7642	7862	
3	6580	6690	6795	6927	7147	7361	7581	7796	8016	
4	6735	6845	6950	7082	7302	7516	7736	7951	8171	

Specify:

- Product Number
- Fabric Vendor, Pattern and Color

See pages 16 & 17 for material and finish options.

Hale Benches

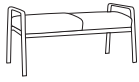

665192 2 SEAT BENCH, METAL FRAME

W: 45.75" D: 21.5" H: 22" SW: 21" SD: 21" SH: 18" AH: 22" WT: 56 lb COM: 2 yd WT CAP: 750 lb

ZONE	B/COM	C	D	E	F	G	H	I	J	GENERAL INFORMATION
1	2890	2930	2968	3016	3096	3174	3254	3332	3412	MATERIAL: Metal MOIS. BARR: \$24
2	2961	3001	3039	3087	3167	3245	3325	3403	3483	
3	3033	3073	3111	3159	3239	3317	3397	3475	3555	
4	3104	3144	3182	3230	3310	3388	3468	3546	3626	



665193 3 SEAT BENCH, METAL FRAME

W: 67.5" D: 21.5" H: 22" SW: 21" SD: 21" SH: 18" AH: 22" WT: 78 lb COM: 2.25 yd WT CAP: 750 lb

ZONE	B/COM	C	D	E	F	G	H	I	J	GENERAL INFORMATION
1	3797	3842	3885	3939	4029	4117	4207	4294	4384	MATERIAL: Metal MOIS. BARR: \$27
2	3891	3936	3979	4033	4123	4211	4301	4388	4478	
3	3985	4030	4073	4127	4217	4305	4395	4482	4572	
4	4079	4124	4167	4221	4311	4399	4489	4576	4666	

Specify:

- Product Number
- Fabric Vendor, Pattern and Color

See pages 16 & 17 for material and finish options.

Hale Patient Chairs



6651721 PATIENT CHAIR, 21" SEAT, METAL FRAME, HIGH BACK

W: 24" D: 24.75" H: 43.75" SW: 21" SD: 19" SH: 18" AH: 25" WT: 40 lb COM: 2.25 yd WT CAP: 550 lb

ZONE	B/COM	C	D	E	F	G	H	I	J	GENERAL INFORMATION
1	1991	2036	2079	2133	2223	2311	2401	2488	2578	MATERIAL: Metal MOIS. BARR: \$27
2	2040	2085	2128	2182	2272	2360	2450	2537	2627	
3	2089	2134	2177	2231	2321	2409	2499	2586	2676	
4	2138	2183	2226	2280	2370	2458	2548	2635	2725	

6651730 PATIENT CHAIR, 30" SEAT, METAL FRAME, HIGH BACK

W: 33" D: 24.75" H: 43.75" SW: 30" SD: 19" SH: 18" AH: 25" WT: 47 lb COM: 3.25 yd WT CAP: 750 lb

ZONE	B/COM	C	D	E	F	G	H	I	J	GENERAL INFORMATION
1	2445	2510	2572	2650	2780	2907	3037	3163	3293	MATERIAL: Metal MOIS. BARR: \$39
2	2505	2570	2632	2710	2840	2967	3097	3223	3353	
3	2565	2630	2692	2770	2900	3027	3157	3283	3413	
4	2624	2689	2751	2829	2959	3086	3216	3342	3472	



6652721 PATIENT CHAIR, 21" SEAT, ARM INSERT, METAL FRAME HIGH BACK

W: 24" D: 24.75" H: 43.75" SW: 21" SD: 19" SH: 18" AH: 25" WT: 40 lb COM: 2.75 yd WT CAP: 550 lb

ZONE	B/COM	C	D	E	F	G	H	I	J	GENERAL INFORMATION
1	2525	2580	2632	2698	2808	2916	3026	3133	3243	MATERIAL: Metal MOIS. BARR: \$33
2	2587	2642	2694	2760	2870	2978	3088	3195	3305	
3	2649	2704	2756	2822	2932	3040	3150	3257	3367	
4	2711	2766	2818	2884	2994	3102	3212	3319	3429	

6652730 PATIENT CHAIR, 30" SEAT, ARM INSERT, METAL FRAME HIGH BACK

W: 33" D: 24.75" H: 43.75" SW: 30" SD: 19" SH: 18" AH: 25" WT: 49 lb COM: 3.25 yd WT CAP: 750 lb

ZONE	B/COM	C	D	E	F	G	H	I	J	GENERAL INFORMATION
1	2979	3044	3106	3184	3314	3441	3571	3697	3827	MATERIAL: Metal MOIS. BARR: \$39
2	3052	3117	3179	3257	3387	3514	3644	3770	3900	
3	3125	3190	3252	3330	3460	3587	3717	3843	3973	
4	3199	3264	3326	3404	3534	3661	3791	3917	4047	



6650100 OTTOMAN, 13" HEIGHT, METAL FRAME

W: 18.5" D: 17" H: 13" SW: - SD: - SH: - AH: - WT: 11.5 lb COM: 1.5 yd WT CAP: 300 lb

ZONE	B/COM	C	D	E	F	G	H	I	J	GENERAL INFORMATION
1	1164	1194	1223	1259	1319	1377	1437	1496	1556	MATERIAL: Metal MOIS. BARR: \$18
2	1192	1222	1251	1287	1347	1405	1465	1524	1584	
3	1221	1251	1280	1316	1376	1434	1494	1553	1613	
4	1250	1280	1309	1345	1405	1463	1523	1582	1642	

Specify:

- Product Number
- Fabric Vendor, Pattern and Color

See pages 16 & 17 for material and finish options.

Hale Motion Chairs



66517M21 MOTION CHAIR, 21" SEAT, METAL FRAME

W: 24.75" D: 24.75" H: 45" SW: 21" SD: 19" SH: 18.5" AH: 25" WT: 64 lb COM: 2.25 yd WT CAP: 550 lb

ZONE	B/COM	C	D	E	F	G	H	I	J	GENERAL INFORMATION
1	2694	2739	2782	2836	2926	3014	3104	3191	3281	MATERIAL: Metal MOIS. BARR: \$27
2	2760	2805	2848	2902	2992	3080	3170	3257	3347	
3	2827	2872	2915	2969	3059	3147	3237	3324	3414	
4	2893	2938	2981	3035	3125	3213	3303	3390	3480	

66517M30 MOTION CHAIR, 30" SEAT, METAL FRAME

W: 33.75" D: 24.75" H: 45" SW: 30" SD: 19" SH: 18.5" AH: 25" WT: 75 lb COM: 3.25 yd WT CAP: 750 lb

ZONE	B/COM	C	D	E	F	G	H	I	J	GENERAL INFORMATION
1	3130	3195	3257	3335	3465	3592	3722	3848	3978	MATERIAL: Metal MOIS. BARR: \$39
2	3207	3272	3334	3412	3542	3669	3799	3925	4055	
3	3284	3349	3411	3489	3619	3746	3876	4002	4132	
4	3361	3426	3488	3566	3696	3823	3953	4079	4209	



6650100M OTTOMAN, 11" HEIGHT, METAL FRAME, MOTION

W: 18.5" D: 17" H: 11" SW: - SD: - SH: - AH: - WT: 10.5 lb COM: 1.5 yd WT CAP: 300 lb

ZONE	B/COM	C	D	E	F	G	H	I	J	GENERAL INFORMATION
1	1091	1121	1150	1186	1246	1304	1364	1423	1483	MATERIAL: Metal MOIS. BARR: \$18
2	1118	1148	1177	1213	1273	1331	1391	1450	1510	
3	1144	1174	1203	1239	1299	1357	1417	1476	1536	
4	1171	1201	1230	1266	1326	1384	1444	1503	1563	

Specify:

- Product Number
- Fabric Vendor,
Pattern and Color

**See pages 16 & 17
for material and finish
options.**

Hale Easy Access Chairs



66511H21 EASY ACCESS CHAIR, 21" SEAT, METAL FRAME

W: 24"	D: 25.5"	H: 40.5"	SW: 21"	SD: 19"	SH: 24.5"	AH: 31.5"	WT: 47 lb	COM: 2 yd	WT CAP: 550 lb	
ZONE	B/COM	C	D	E	F	G	H	I	J	GENERAL INFORMATION
1	2475	2515	2553	2601	2681	2759	2839	2917	2997	MATERIAL: Metal MOIS. BARR: \$24
2	2536	2576	2614	2662	2742	2820	2900	2978	3058	
3	2597	2637	2675	2723	2803	2881	2961	3039	3119	
4	2658	2698	2736	2784	2864	2942	3022	3100	3180	

66511H30 EASY ACCESS CHAIR, 30" SEAT, METAL FRAME

W: 33"	D: 25.5"	H: 40.5"	SW: 30"	SD: 19"	SH: 24.5"	AH: 31.5"	WT: 70 lb	COM: 2.75 yd	WT CAP: 750 lb	
ZONE	B/COM	C	D	E	F	G	H	I	J	GENERAL INFORMATION
1	2766	2821	2873	2939	3049	3157	3267	3374	3484	MATERIAL: Metal MOIS. BARR: \$33
2	2834	2889	2941	3007	3117	3225	3335	3442	3552	
3	2902	2957	3009	3075	3185	3293	3403	3510	3620	
4	2970	3025	3077	3143	3253	3361	3471	3578	3688	



66521H21 EASY ACCESS CHAIR, 21" SEAT, ARM INSERT, METAL FRAME

W: 24"	D: 25.5"	H: 40.5"	SW: 21"	SD: 19"	SH: 24.5"	AH: 31.5"	WT: 49 lb	COM: 2.5 yd	WT CAP: 550 lb	
ZONE	B/COM	C	D	E	F	G	H	I	J	GENERAL INFORMATION
1	2991	3041	3089	3149	3249	3346	3446	3544	3644	MATERIAL: Metal MOIS. BARR: \$30
2	3065	3115	3163	3223	3323	3420	3520	3618	3718	
3	3139	3189	3237	3297	3397	3494	3594	3692	3792	
4	3212	3262	3310	3370	3470	3567	3667	3765	3865	

66521H30 EASY ACCESS CHAIR, 30" SEAT, ARM INSERT, METAL FRAME

W: 33"	D: 25.5"	H: 40.5"	SW: 30"	SD: 19"	SH: 24.5"	AH: 31.5"	WT: 72 lb	COM: 2.75 yd	WT CAP: 750 lb	
ZONE	B/COM	C	D	E	F	G	H	I	J	GENERAL INFORMATION
1	3278	3333	3385	3451	3561	3669	3779	3886	3996	MATERIAL: Metal MOIS. BARR: \$33
2	3359	3414	3466	3532	3642	3750	3860	3967	4077	
3	3440	3495	3547	3613	3723	3831	3941	4048	4158	
4	3521	3576	3628	3694	3804	3912	4022	4129	4239	

Specify:

- Product Number
- Fabric Vendor, Pattern and Color

See pages 16 & 17 for material and finish options.

Hale Modular Tables

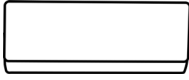

66500-ST SPANNER TABLE, MODULAR

W: 22" D: 18" H: 14.5" WT: 23 lb

Zone	1	2	3	4
	883	905	927	949

GENERAL INFORMATION

MATERIAL: Metal
MOIS BARR: -

Not available with arm insert models. Specify thermoform or solid surface. Thermoform is standard. See beginning of section for details.

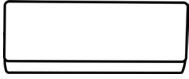

66500-ETR END TABLE, MODULAR, RIGHT

W: 22" D: 18" H: 14.5" WT: 24 lb

Zone	1	2	3	4
	1088	1115	1142	1170

GENERAL INFORMATION

MATERIAL: Metal
MOIS BARR: -

Not available with arm insert models. Specify thermoform or solid surface. Thermoform is standard. See beginning of section for details.
Modular table orders must include a layout to ensure proper configuration.

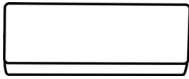

66500-ETL END TABLE, MODULAR, LEFT

W: 22" D: 18" H: 14.5" WT: 24 lb

Zone	1	2	3	4
	1088	1115	1142	1170

GENERAL INFORMATION

MATERIAL: Metal
MOIS BARR: -

Not available with arm insert models. Specify thermoform or solid surface. Thermoform is standard. See beginning of section for details.
Modular table orders must include a layout to ensure proper configuration.

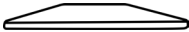

66500-CTAO CORNER TABLE, ANGLED, OUTSIDE MODULAR

W: 34" D: 12" H: 14.5" WT: 20 lb

Zone	1	2	3	4
	1314	1347	1380	1413

GENERAL INFORMATION

MATERIAL: Metal
MOIS BARR: -

Not available with arm insert models. Specify thermoform or solid surface. Thermoform is standard. See beginning of section for details.
Modular table orders must include a layout to ensure proper configuration.



66500-CT CORNER TABLE, MODULAR

W: 28.5" D: 28.5" H: 14.5" WT: 39 lb

Zone	1	2	3	4
	1314	1347	1380	1413

GENERAL INFORMATION

MATERIAL: Metal
MOIS BARR: -

Not available with arm insert models. Specify thermoform or solid surface. Thermoform is standard. See beginning of section for details.
Modular table orders must include a layout to ensure proper configuration.

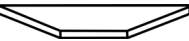

66500-CTAI CORNER TABLE, ANGLED, INSIDE MODULAR

W: 40" D: 22.5" H: 14.5" WT: 23 lb

Zone	1	2	3	4
	1202	1232	1262	1292

GENERAL INFORMATION

MATERIAL: Metal
MOIS BARR: -

Not available with arm insert models. Specify thermoform or solid surface. Thermoform is standard. See beginning of section for details.
Modular table orders must include a layout to ensure proper configuration.

Specify:

- Product Number
- Thermoform Finish
- Solid Surface Name and Number

See pages 16 & 17 for material and finish options.

ARM OPTIONS

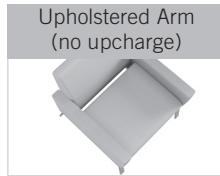

Standard.



\$419
10322 (set of 3)

\$558
10312CT, 10323 (set of 4)
Specify wood finish (Beech).



\$632
10312CT, 10322 (set of 3)

\$842
10312CT, 10323 (set of 4)
Specify solid surface color.

TABLE OPTIONS

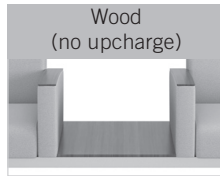

Standard. Specify wood finish (Beech).

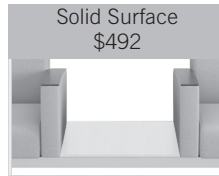

10312CT, 10392CT
Specify solid surface color.



10312WT (pair)
Specify solid surface color.

POWER OPTIONS



Specify white or black.
Power outlet is mounted on the left hand facing side on single seat chairs 10311 and 1031130, all others are mounted in the center.



10311 CHAIR

W: 27" D: 28.75" H: 32" SW: 22" SD: 20.5" SH: 18.75" AH: 24" WT: 65 lb COM: 3 yd WT CAP: 550 lb

ZONE	B/COM	C	D	E	F	G	H	I	J	GENERAL INFORMATION
1	3176	3231	3283	3349	3459	3567	3677	3784	3894	MATERIAL: Varies
2	3254	3309	3361	3427	3537	3645	3755	3862	3972	MOIS. BARR: Included
3	3333	3388	3440	3506	3616	3724	3834	3941	4051	
4	3411	3466	3518	3584	3694	3802	3912	4019	4129	

1031130 CHAIR, WIDE

W: 35" D: 28.75" H: 32" SW: 30" SD: 20.5" SH: 18.75" AH: 24" WT: 65 lb COM: 3.25 yd WT CAP: 550 lb

ZONE	B/COM	C	D	E	F	G	H	I	J	GENERAL INFORMATION
1	3938	4003	4065	4143	4273	4400	4530	4656	4786	MATERIAL: Varies
2	4035	4100	4162	4240	4370	4497	4627	4753	4883	MOIS. BARR: Included
3	4132	4197	4259	4337	4467	4594	4724	4850	4980	
4	4229	4294	4356	4434	4564	4691	4821	4947	5077	



10312 LOVESEAT

W: 49" D: 28.75" H: 32" SW: 22" SD: 20.5" SH: 18.75" AH: 24" WT: 86 lb COM: 4 yd WT CAP: 750 lb

ZONE	B/COM	C	D	E	F	G	H	I	J	GENERAL INFORMATION
1	4593	4673	4749	4845	5005	5161	5321	5477	5637	MATERIAL: Varies
2	4706	4786	4862	4958	5118	5274	5434	5590	5750	MOIS. BARR: Included
3	4819	4899	4975	5071	5231	5387	5547	5703	5863	
4	4933	5013	5089	5185	5345	5501	5661	5817	5977	

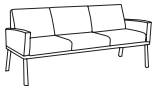

10313 SOFA

W: 71" D: 28.75" H: 32" SW: 22" SD: 20.5" SH: 18.75" AH: 24" WT: 107 lb COM: 5.25 yd WT CAP: 750 lb

ZONE	B/COM	C	D	E	F	G	H	I	J	GENERAL INFORMATION
1	5581	5686	5786	5912	6122	6327	6537	6741	6951	MATERIAL: Varies
2	5718	5823	5923	6049	6259	6464	6674	6878	7088	MOIS. BARR: Included
3	5856	5961	6061	6187	6397	6602	6812	7016	7226	
4	5993	6098	6198	6324	6534	6739	6949	7153	7363	



10322 LOVESEAT, CENTER ARM

W: 51.5" D: 28.75" H: 32" SW: 22" SD: 20.5" SH: 18.75" AH: 24" WT: 86 lb COM: 4.5 yd WT CAP: 750 lb

ZONE	B/COM	C	D	E	F	G	H	I	J	GENERAL INFORMATION
1	4875	4965	5051	5159	5339	5514	5694	5870	6050	MATERIAL: Varies
2	4995	5085	5171	5279	5459	5634	5814	5990	6170	MOIS. BARR: Included
3	5115	5205	5291	5399	5579	5754	5934	6110	6290	
4	5235	5325	5411	5519	5699	5874	6054	6230	6410	

10323 SOFA, CENTER ARM

W: 76" D: 28.75" H: 32" SW: 22" SD: 20.5" SH: 18.75" AH: 24" WT: 107 lb COM: 6.25 yd WT CAP: 750 lb

ZONE	B/COM	C	D	E	F	G	H	I	J	GENERAL INFORMATION
1	6315	6440	6559	6709	6959	7203	7453	7696	7946	MATERIAL: Varies
2	6470	6595	6714	6864	7114	7358	7608	7851	8101	MOIS. BARR: Included
3	6626	6751	6870	7020	7270	7514	7764	8007	8257	
4	6781	6906	7025	7175	7425	7669	7919	8162	8412	

Specify:

- Product Number
- Wood Finish
- Fabric Vendor, Pattern and Color
- Solid Surface Name and Number

See pages 16 & 17 for material and finish options.

Latitude



10312CT 2 SEAT, CENTER TABLE

W: 71"	D: 28.75"	H: 32"	SW: 22"	SD: 20.5"	SH: 18.75"	AH: 24"	WT: 126	COM: 5 yd	WT CAP: 750 lb	
ZONE	B/COM	C	D	E	F	G	H	I	J	GENERAL INFORMATION
1	5574	5674	5769	5889	6089	6284	6484	6679	6879	MATERIAL: Varies
2	5711	5811	5906	6026	6226	6421	6621	6816	7016	MOIS. BARR: Included
3	5849	5949	6044	6164	6364	6559	6759	6954	7154	
4	5986	6086	6181	6301	6501	6696	6896	7091	7291	



10312WT LOVESEAT, WING TABLES

W: 71"	D: 28.75"	H: 32"	SW: 22"	SD: 20.5"	SH: 18.75"	AH: 24"	WT: 104 lb	COM: 4 yd	WT CAP: 750 lb	
ZONE	B/COM	C	D	E	F	G	H	I	J	GENERAL INFORMATION
1	5300	5380	5456	5552	5712	5868	6028	6184	6344	MATERIAL: Varies
2	5431	5511	5587	5683	5843	5999	6159	6315	6475	MOIS. BARR: Included
3	5562	5642	5718	5814	5974	6130	6290	6446	6606	
4	5693	5773	5849	5945	6105	6261	6421	6577	6737	

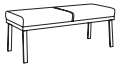

10392 2-SEAT BENCH

W: 43.5"	D: 17.75"	H: 17.5"	SW: 22"	SD: 18.75"	SH: 17.5"	AH: -	WT: 104 lb	COM: 1.75 yd	WT CAP: 750 lb	
ZONE	B/COM	C	D	E	F	G	H	I	J	GENERAL INFORMATION
1	3867	3902	3935	3977	4047	4116	4186	4254	4324	MATERIAL: Metal
2	3963	3998	4031	4073	4143	4212	4282	4350	4420	MOIS. BARR: Included
3	4059	4094	4127	4169	4239	4308	4378	4446	4516	
4	4155	4190	4223	4265	4335	4404	4474	4542	4612	

10393 3-SEAT BENCH

W: 65.5"	D: 17.75"	H: 17.5"	SW: 22"	SD: 18.75"	SH: 17.5"	AH: -	WT: 104 lb	COM: 2.75 yd	WT CAP: 750 lb	
ZONE	B/COM	C	D	E	F	G	H	I	J	GENERAL INFORMATION
1	4685	4740	4792	4858	4968	5076	5186	5293	5403	MATERIAL: Metal
2	4801	4856	4908	4974	5084	5192	5302	5409	5519	MOIS. BARR: Included
3	4917	4972	5024	5090	5200	5308	5418	5525	5635	
4	5033	5088	5140	5206	5316	5424	5534	5641	5751	

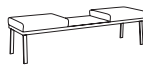

10392CT 2-SEAT BENCH, CENTER TABLE

W: 65.5"	D: 17.75"	H: 17.5"	SW: 22"	SD: 18.75"	SH: 7.5"	AH: -	WT: 104 lb	COM: 1.75 yd	WT CAP: 750 lb	
ZONE	B/COM	C	D	E	F	G	H	I	J	GENERAL INFORMATION
1	4680	4715	4748	4790	4860	4929	4999	5067	5137	MATERIAL: Varies
2	4796	4831	4864	4906	4976	5045	5115	5183	5253	MOIS. BARR: Included
3	4913	4948	4981	5023	5093	5162	5232	5300	5370	
4	5029	5064	5097	5139	5209	5278	5348	5416	5486	

Specify:

- Product Number
- Wood Finish
- Fabric Vendor, Pattern and Color
- Solid Surface Name and Number

See pages 16 & 17 for material and finish options.



7324001 CHAIR, WOOD ARM, LOW BACK

W: 24" D: 25.5" H: 33" SW: 20" SD: 18.75" SH: 18" AH: 25.75" WT: 27 lb COM: 1.5 yd WT CAP: 300 lb

ZONE	B/COM	C	D	E	F	G	H	I	J	GENERAL INFORMATION
1	1424	1454	1483	1519	1579	1637	1697	1756	1816	MATERIAL: Beech MOIS. BARR: \$18
2	1459	1489	1518	1554	1614	1672	1732	1791	1851	
3	1494	1524	1553	1589	1649	1707	1767	1826	1886	
4	1529	1559	1588	1624	1684	1742	1802	1861	1921	



7324002 CHAIR, WOOD ARM, MID BACK

W: 24" D: 25.5" H: 39" SW: 20" SD: 18.75" SH: 18" AH: 25.75" WT: 30 lb COM: 1.5 yd WT CAP: 300 lb

ZONE	B/COM	C	D	E	F	G	H	I	J	GENERAL INFORMATION
1	1523	1553	1582	1618	1678	1736	1796	1855	1915	MATERIAL: Beech MOIS. BARR: \$18
2	1560	1590	1619	1655	1715	1773	1833	1892	1952	
3	1598	1628	1657	1693	1753	1811	1871	1930	1990	
4	1635	1665	1694	1730	1790	1848	1908	1967	2027	

Accessories

URETHANE ARM CAPS

\$200 2 Arms Available in black, sable or dove.

Specify:

- Product Number
- Wood Finish
- Urethane Finish
- Fabric Vendor, Pattern and Color

See pages 16 & 17 for material and finish options.

Laurelwood Patient and Motion



7324003 PATIENT CHAIR, WOOD ARM, HIGH BACK

W: 24"	D: 25.5"	H: 43"	SW: 20"	SD: 18.75"	SH: 18"	AH: 25.75"	WT: 32 lb	COM: 2.2 yd	WT CAP: 300 lb	
ZONE	B/COM	C	D	E	F	G	H	I	J	GENERAL INFORMATION
1	1650	1694	1736	1789	1877	1963	2051	2136	2224	MATERIAL: Beech MOIS. BARR: \$26
2	1690	1734	1776	1829	1917	2003	2091	2176	2264	
3	1731	1775	1817	1870	1958	2044	2132	2217	2305	
4	1771	1815	1857	1910	1998	2084	2172	2257	2345	



7324007 MOTION CHAIR, WOOD ARM, MID BACK

W: 25"	D: 26.5"	H: 39"	SW: 20.25"	SD: 18.75"	SH: 18"	AH: 25.75"	WT: 49 lb	COM: 2.2 yd	WT CAP: 300 lb	
ZONE	B/COM	C	D	E	F	G	H	I	J	GENERAL INFORMATION
1	2440	2484	2526	2579	2667	2753	2841	2926	3014	MATERIAL: Beech MOIS. BARR: \$26
2	2500	2544	2586	2639	2727	2813	2901	2986	3074	
3	2560	2604	2646	2699	2787	2873	2961	3046	3134	
4	2620	2664	2706	2759	2847	2933	3021	3106	3194	

Leg extensions are not available on motion chairs. Casters (7144002) are available on rear legs only. Casters must be locking. Non-skid slides are provided on the front legs.



7324008 MOTION PATIENT CHAIR, WOOD ARM, HIGH BACK

W: 25"	D: 26.5"	H: 45"	SW: 20.25"	SD: 18.25"	SH: 18"	AH: 25.75"	WT: 51 lb	COM: 2.2 yd	WT CAP: 300 lb	
ZONE	B/COM	C	D	E	F	G	H	I	J	GENERAL INFORMATION
1	2515	2559	2601	2654	2742	2828	2916	3001	3089	MATERIAL: Beech MOIS. BARR: \$26
2	2577	2621	2663	2716	2804	2890	2978	3063	3151	
3	2639	2683	2725	2778	2866	2952	3040	3125	3213	
4	2701	2745	2787	2840	2928	3014	3102	3187	3275	

Leg extensions are not available on motion chairs. Casters (7144002) are available on rear legs only. Casters must be locking. Non-skid slides are provided on the front legs.



7024007 OTTOMAN, 10" HEIGHT

W: 19"	D: 16"	H: 10"	SW: -	SD: -	SH: -	AH: -	WT: 9 lb	COM: .4 yd	WT CAP: 300 lb	
ZONE	B/COM	C	D	E	F	G	H	I	J	GENERAL INFORMATION
1	963	971	979	989	1005	1020	1036	1052	1068	MATERIAL: Beech MOIS. BARR: \$5
2	987	995	1003	1013	1029	1044	1060	1076	1092	
3	1011	1019	1027	1037	1053	1068	1084	1100	1116	
4	1035	1043	1051	1061	1077	1092	1108	1124	1140	



7024008 OTTOMAN, 18" HEIGHT

W: 19"	D: 16.75"	H: 18"	SW: -	SD: -	SH: -	AH: -	WT: 15 lb	COM: .4 yd	WT CAP: 300 lb	
ZONE	B/COM	C	D	E	F	G	H	I	J	GENERAL INFORMATION
1	963	971	979	989	1005	1020	1036	1052	1068	MATERIAL: Beech MOIS. BARR: \$5
2	987	995	1003	1013	1029	1044	1060	1076	1092	
3	1011	1019	1027	1037	1053	1068	1084	1100	1116	
4	1035	1043	1051	1061	1077	1092	1108	1124	1140	

Cannot be used with motion chairs.

Accessories

URETHANE ARM CAPS

\$200 2 Arms Available in black, sable or dove.

Specify:

- Product Number
- Wood Finish
- Urethane Finish
- Fabric Vendor, Pattern and Color

See pages 16 & 17 for material and finish options.

Laurelwood Bariatric



7324057 BARIATRIC CHAIR, 20" SEAT, WOOD ARM

W: 24" D: 25.5" H: 35" SW: 20" SD: 18.75" SH: 18" AH: 25.75" WT: 27 lb COM: 1.5 yd WT CAP: 750 lb

ZONE	B/COM	C	D	E	F	G	H	I	J	GENERAL INFORMATION
1	1523	1553	1582	1618	1678	1736	1796	1855	1915	MATERIAL: Beech MOIS. BARR: \$18
2	1560	1590	1619	1655	1715	1773	1833	1892	1952	
3	1598	1628	1657	1693	1753	1811	1871	1930	1990	
4	1635	1665	1694	1730	1790	1848	1908	1967	2027	

7324051 BARIATRIC CHAIR, 25" SEAT, WOOD ARM

W: 29" D: 24.75" H: 35" SW: 25" SD: 18.75" SH: 18" AH: 25.75" WT: 34 lb COM: 2.3 yd WT CAP: 750 lb

ZONE	B/COM	C	D	E	F	G	H	I	J	GENERAL INFORMATION
1	2140	2186	2230	2285	2377	2466	2558	2648	2740	MATERIAL: Beech MOIS. BARR: \$28
2	2193	2239	2283	2338	2430	2519	2611	2701	2793	
3	2245	2291	2335	2390	2482	2571	2663	2753	2845	
4	2298	2344	2388	2443	2535	2624	2716	2806	2898	



7324052 BARIATRIC CHAIR, 30" SEAT, WOOD ARM

W: 34" D: 24.75" H: 35" SW: 30" SD: 18.75" SH: 18" AH: 25.75" WT: 38 lb COM: 2.3 yd WT CAP: 750 lb

ZONE	B/COM	C	D	E	F	G	H	I	J	GENERAL INFORMATION
1	2288	2334	2378	2433	2525	2614	2706	2796	2888	MATERIAL: Beech MOIS. BARR: \$28
2	2344	2390	2434	2489	2581	2670	2762	2852	2944	
3	2401	2447	2491	2546	2638	2727	2819	2909	3001	
4	2457	2503	2547	2602	2694	2783	2875	2965	3057	

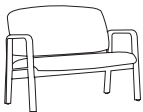

7324053 BARIATRIC LOVESEAT, 40" SEAT, WOOD ARM

W: 44" D: 24.75" H: 35" SW: 40" SD: 18.75" SH: 18" AH: 25.75" WT: 44 lb COM: 2.7 yd WT CAP: 750 lb

ZONE	B/COM	C	D	E	F	G	H	I	J	GENERAL INFORMATION
1	2458	2512	2564	2628	2736	2842	2950	3055	3163	MATERIAL: Beech MOIS. BARR: \$32
2	2518	2572	2624	2688	2796	2902	3010	3115	3223	
3	2579	2633	2685	2749	2857	2963	3071	3176	3284	
4	2639	2693	2745	2809	2917	3023	3131	3236	3344	

Accessories

URETHANE ARM CAPS

\$200 2 Arms Available in black, sable or dove.

Specify:

- Product Number
- Wood Finish
- Urethane Cap Color
- Fabric Vendor, Pattern and Color

See pages 16 & 17 for material and finish options.

Laurelwood Bariatric Mid Back



7324060 BARIATRIC CHAIR, 25" SEAT, WOOD ARM, MID-BACK

W: 29" D: 24.75" H: 39" SW: 25" SD: 18.75" SH: 18" AH: 25.75" WT: 37 lb COM: 2.5 yd WT CAP: 750 lb

ZONE	B/COM	C	D	E	F	G	H	I	J	GENERAL INFORMATION
1	2245	2295	2343	2403	2503	2600	2700	2798	2898	MATERIAL: Beech MOIS. BARR: \$30
2	2300	2350	2398	2458	2558	2655	2755	2853	2953	
3	2355	2405	2453	2513	2613	2710	2810	2908	3008	
4	2410	2460	2508	2568	2668	2765	2865	2963	3063	



7324061 BARIATRIC CHAIR, 30" SEAT, WOOD ARM, MID-BACK

W: 34" D: 24.75" H: 39" SW: 30" SD: 18.75" SH: 18" AH: 25.75" WT: 43 lb COM: 2.5 yd WT CAP: 750 lb

ZONE	B/COM	C	D	E	F	G	H	I	J	GENERAL INFORMATION
1	2390	2440	2488	2548	2648	2745	2845	2943	3043	MATERIAL: Beech MOIS. BARR: \$30
2	2449	2499	2547	2607	2707	2804	2904	3002	3102	
3	2508	2558	2606	2666	2766	2863	2963	3061	3161	
4	2566	2616	2664	2724	2824	2921	3021	3119	3219	

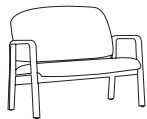

7324062 BARIATRIC LOVESEAT, 40" SEAT, WOOD ARM, MID-BACK

W: 44" D: 24.75" H: 39" SW: 40" SD: 18.75" SH: 18" AH: 25.75" WT: 49 lb COM: 2.7 yd WT CAP: 750 lb

ZONE	B/COM	C	D	E	F	G	H	I	J	GENERAL INFORMATION
1	2560	2614	2666	2730	2838	2944	3052	3157	3265	MATERIAL: Beech MOIS. BARR: \$32
2	2623	2677	2729	2793	2901	3007	3115	3220	3328	
3	2686	2740	2792	2856	2964	3070	3178	3283	3391	
4	2749	2803	2855	2919	3027	3133	3241	3346	3454	

Accessories



~~7070009 LEG EXTENSIONS (SET OF FOUR)~~

~~\$454 WT: 2 lb~~

~~Price includes glides. Adjusts height from 1" to 5". Standard color is Champagne Bronze. Available on all Laurelwood and Wedgewood chairs. Leg extensions are not available on motion chairs.~~



7144001 REAR LOCKING CASTERS, FRONT NON-LOCKING, CARPET SURFACE (SET OF FOUR)

STEM SIZE: 50 mm CASTER SIZE: 2"
LOAD CAP: 110 lb p/caster WT: 1 lb

\$135

Includes two front non-locking casters and two rear locking casters.



7144002 CASTERS, CARPET SURFACE (SET OF TWO)

STEM SIZE: 50 mm CASTER SIZE: 2"
LOAD CAP: 110 lb p/caster WT: 0.5 lb

\$108

Specify locking or non-locking for front or rear legs when ordering.



7144003 REAR LOCKING CASTERS, FRONT NON-LOCKING, HARD SURFACE (SET OF FOUR)

STEM SIZE: 50 mm CASTER SIZE: 2"
LOAD CAP: 110 lb p/caster WT: 1 lb

\$135

Includes two front non-locking casters and two rear locking casters.



7144004 CASTERS, HARD SURFACE (SET OF TWO)

STEM SIZE: 50 mm CASTER SIZE: 2"
LOAD CAP: 110 lb p/caster WT: 0.5 lb

\$108

Specify locking or non-locking for front or rear legs when ordering.



7144100 TIP BACK CASTERS (SET OF TWO)

\$122 per chair WT: 0.5 lb

URETHANE ARM CAPS

\$200 2 Arms

Available in black, sable or dove.

Specify:

- Product Number
- Wood Finish
- Urethane Cap Color
- Fabric Vendor, Pattern and Color

See pages 16 & 17 for material and finish options.



7026600 SIDE CHAIR, UPH SEAT AND BACK

W: 19" D: 26" H: 32" SW: 19" SD: 18.5" SH: 18.5" AH: - WT: 17 lb COM: 1.5 yd WT CAP: 500 lb

ZONE	B/COM	C	D	E	F	G	H	I	J	GENERAL INFORMATION
1	847	877	906	942	1002	1060	1120	1179	1239	MATERIAL: Beech MOIS. BARR: Included
2	868	898	927	963	1023	1081	1141	1200	1260	
3	888	918	947	983	1043	1101	1161	1220	1280	
4	909	939	968	1004	1064	1122	1182	1241	1301	

Price includes Plastitack glides. Modular seating orders must include a layout to ensure proper configuration.

7026601 SIDE CHAIR, WIDE, UPH SEAT AND BACK

W: 27" D: 26" H: 32" SW: 27" SD: 18.5" SH: 18.5" AH: - WT: 22 lb COM: 2.25 yd WT CAP: 750 lb

ZONE	B/COM	C	D	E	F	G	H	I	J	GENERAL INFORMATION
1	975	1020	1063	1117	1207	1295	1385	1472	1562	MATERIAL: Beech MOIS. BARR: Included
2	998	1043	1086	1140	1230	1318	1408	1495	1585	
3	1022	1067	1110	1164	1254	1342	1432	1519	1609	
4	1045	1090	1133	1187	1277	1365	1455	1542	1632	

Price includes Plastitack glides. Modular seating orders must include a layout to ensure proper configuration.



7326600 ARM CHAIR, UPH SEAT AND BACK

W: 21.5" D: 26" H: 32" SW: 19" SD: 18.5" SH: 18.5" AH: 26.5" WT: 18 lb COM: 1.5 yd WT CAP: 500 lb

ZONE	B/COM	C	D	E	F	G	H	I	J	GENERAL INFORMATION
1	982	1012	1041	1077	1137	1195	1255	1314	1374	MATERIAL: Beech MOIS. BARR: Included
2	1006	1036	1065	1101	1161	1219	1279	1338	1398	
3	1030	1060	1089	1125	1185	1243	1303	1362	1422	
4	1054	1084	1113	1149	1209	1267	1327	1386	1446	

Price includes Plastitack glides. Nylon arm caps are available in black, sable or dove. Modular seating orders must include a layout to ensure proper configuration. There is a deduct per chair if specified without arm caps. Call for details.

7326601 ARM CHAIR, WIDE, UPH SEAT AND BACK

W: 29.5" D: 26" H: 32" SW: 27" SD: 18.5" SH: 18.5" AH: 26.5" WT: 22 lb COM: 2.25 yd WT CAP: 750 lb

ZONE	B/COM	C	D	E	F	G	H	I	J	GENERAL INFORMATION
1	1114	1159	1202	1256	1346	1434	1524	1611	1701	MATERIAL: Beech MOIS. BARR: Included
2	1141	1186	1229	1283	1373	1461	1551	1638	1728	
3	1168	1213	1256	1310	1400	1488	1578	1665	1755	
4	1195	1240	1283	1337	1427	1515	1605	1692	1782	

Price includes Plastitack glides. Nylon arm caps are available in black, sable or dove. Modular seating orders must include a layout to ensure proper configuration. There is a deduct per chair if specified without arm caps. Call for details.

Accessories



7076600 GANGING KIT

\$43 per kit

Add one ganging kit for each chair or table. Arm an d armless chairs and tables can be ganged.

OPTIONAL NYLON ARM CAPS

-\$25 DEDUCT

There is a deduct per chair if specified without arm caps.

Specify:
 Product Number
 Wood Finish
 Arm Cap Color
 Fabric Vendor, Pattern and Color
See pages 16 & 17 for material and finish options.



7016600 SPANNER TABLE, NARROW

GENERAL INFORMATION

W: 19" D: 26" H: 20" WT: 18 lb

MATERIAL: Beech
MOIS. BARR: -

Zone	1	2	3	4
	917	940	963	986

Price includes Plastitack glides. Tops are available with thermoform, laminate with self-edge or laminate with vinyl edge. Specify black, white, brown, gray, or almond. Modular seating orders must include a layout to ensure proper configuration.

7016601 SPANNER TABLE, WIDE

GENERAL INFORMATION

W: 29.5" D: 26" H: 20" WT: 26 lb

MATERIAL: Beech
MOIS. BARR: -

Zone	1	2	3	4
	1038	1064	1090	1116

Price includes Plastitack glides. Tops are available with thermoform, laminate with self-edge or laminate with vinyl edge. Specify black, white, brown, gray, or almond. Modular seating orders must include a layout to ensure proper configuration.

Accessories



7076600 GANGING KIT

\$43 per kit

Add one ganging kit for each chair or table. Arm and armless chairs and tables can be ganged.

Specify:

- Product Number
- Thermoform Color
- Laminate Vendor, Pattern and Finish
- T-Mold Edge Color

See pages 16 & 17 for material and finish options.



68MN01M CHAIR, WOOD ARM

W: 25.25" D: 26.25" H: 33.75" SW: 21" SD: 18" SH: 18" AH: 25" WT: 22 lb COM: 1.75 yd WT CAP: 500 lb

ZONE	B/COM	C	D	E	F	G	H	I	J	GENERAL INFORMATION
1	1554	1589	1622	1664	1734	1803	1873	1941	2011	MATERIAL: Beech MOIS. BARR: \$21
2	1592	1627	1660	1702	1772	1841	1911	1979	2049	
3	1630	1665	1698	1740	1810	1879	1949	2017	2087	
4	1668	1703	1736	1778	1848	1917	1987	2055	2125	

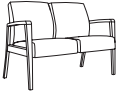

68MN02M LOVESEAT, WOOD ARM

W: 44.75" D: 26.25" H: 33.75" SW: 21" SD: 18" SH: 18" AH: 25" WT: 49 lb COM: 3.5 yd WT CAP: 750 lb

ZONE	B/COM	C	D	E	F	G	H	I	J	GENERAL INFORMATION
1	2492	2562	2629	2713	2853	2989	3129	3266	3406	MATERIAL: Beech MOIS. BARR: \$42
2	2553	2623	2690	2774	2914	3050	3190	3327	3467	
3	2614	2684	2751	2835	2975	3111	3251	3388	3528	
4	2675	2745	2812	2896	3036	3172	3312	3449	3589	

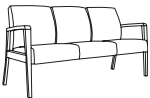

68MN03M SOFA, WOOD ARM

W: 67.5" D: 26.25" H: 33.75" SW: 21" SD: 18" SH: 18" AH: 25" WT: 73 lb COM: 5.25 yd WT CAP: 1000 lb

ZONE	B/COM	C	D	E	F	G	H	I	J	GENERAL INFORMATION
1	3471	3576	3676	3802	4012	4217	4427	4631	4841	MATERIAL: Beech MOIS. BARR: \$63
2	3556	3661	3761	3887	4097	4302	4512	4716	4926	
3	3640	3745	3845	3971	4181	4386	4596	4800	5010	
4	3725	3830	3930	4056	4266	4471	4681	4885	5095	



68MN12M LOVESEAT, WOOD ARM, SHORT CENTER ARMS

W: 48" D: 26.25" H: 33.75" SW: 21" SD: 18" SH: 18" AH: 25" WT: 49 lb COM: 3.5 yd WT CAP: 750 lb

ZONE	B/COM	C	D	E	F	G	H	I	J	GENERAL INFORMATION
1	2766	2836	2903	2987	3127	3263	3403	3540	3680	MATERIAL: Beech MOIS. BARR: \$42
2	2834	2904	2971	3055	3195	3331	3471	3608	3748	
3	2902	2972	3039	3123	3263	3399	3539	3676	3816	
4	2969	3039	3106	3190	3330	3466	3606	3743	3883	

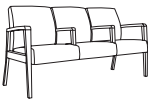

68MN13M SOFA, WOOD ARM, SHORT CENTER ARMS

W: 70.5" D: 26.25" H: 33.75" SW: 21" SD: 18" SH: 18" AH: 25" WT: 73 lb COM: 5.25 yd WT CAP: 1000 lb

ZONE	B/COM	C	D	E	F	G	H	I	J	GENERAL INFORMATION
1	4064	4169	4269	4395	4605	4810	5020	5224	5434	MATERIAL: Beech MOIS. BARR: \$63
2	4164	4269	4369	4495	4705	4910	5120	5324	5534	
3	4263	4368	4468	4594	4804	5009	5219	5423	5633	
4	4362	4467	4567	4693	4903	5108	5318	5522	5732	

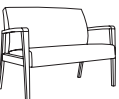

68MN01L LOVESEAT, WOOD ARM, CONTINUOUS SEAT

W: 46.25" D: 26.25" H: 33.75" SW: 42" SD: 18" SH: 18" AH: 25" WT: 49 lb COM: 4 yd WT CAP: 750 lb

ZONE	B/COM	C	D	E	F	G	H	I	J	GENERAL INFORMATION
1	2512	2592	2668	2764	2924	3080	3240	3396	3556	MATERIAL: Beech MOIS. BARR: \$48
2	2573	2653	2729	2825	2985	3141	3301	3457	3617	
3	2634	2714	2790	2886	3046	3202	3362	3518	3678	
4	2696	2776	2852	2948	3108	3264	3424	3580	3740	

Specify:

- Product Number
- Wood Finish
- Fabric Vendor, Pattern and Color

See pages 16 & 17 for material and finish options.

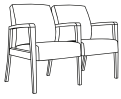

68MN22M 2 SEAT TANDEM, WOOD ARM

W: 48"	D: 26.25"	H: 33.75"	SW: 21"	SD: 18"	SH: 18"	AH: 25"	WT: 49 lb	COM: 3.5 yd	WT CAP: 750 lb	
ZONE	B/COM	C	D	E	F	G	H	I	J	GENERAL INFORMATION
1	2766	2836	2903	2987	3127	3263	3403	3540	3680	MATERIAL: Beech
2	2834	2904	2971	3055	3195	3331	3471	3608	3748	MOIS. BARR: \$42
3	2902	2972	3039	3123	3263	3399	3539	3676	3816	
4	2969	3039	3106	3190	3330	3466	3606	3743	3883	



68MN23M 3 SEAT TANDEM, WOOD ARM

W: 70.5"	D: 26.25"	H: 33.75"	SW: 21"	SD: 18"	SH: 18"	AH: 25"	WT: 73 lb	COM: 5.25 yd	WT CAP: 500 lb	
ZONE	B/COM	C	D	E	F	G	H	I	J	GENERAL INFORMATION
1	4064	4169	4269	4395	4605	4810	5020	5224	5434	MATERIAL: Beech
2	4164	4269	4369	4495	4705	4910	5120	5324	5534	MOIS. BARR: \$63
3	4263	4368	4468	4594	4804	5009	5219	5423	5633	
4	4362	4467	4567	4693	4903	5108	5318	5522	5732	



68MN01G CHAIR, WIDE, WOOD ARM, BARIATRIC

W: 34.25"	D: 26.25"	H: 33.75"	SW: 30"	SD: 18"	SH: 18"	AH: 25"	WT: 32 lb	COM: 3 yd	WT CAP: 750 lb	
ZONE	B/COM	C	D	E	F	G	H	I	J	GENERAL INFORMATION
1	2126	2186	2243	2315	2435	2552	2672	2789	2909	MATERIAL: Beech
2	2178	2238	2295	2367	2487	2604	2724	2841	2961	MOIS. BARR: \$36
3	2230	2290	2347	2419	2539	2656	2776	2893	3013	
4	2282	2342	2399	2471	2591	2708	2828	2945	3065	

Accessories

URETHANE ARM CAPS

\$140	2 Arms
\$210	3 Arms
\$280	4 Arms

Available in black only.

Specify:

- Product Number
- Wood Finish
- Fabric Vendor, Pattern and Color

See pages 16 & 17 for material and finish options.



68MN01H PATIENT CHAIR, WOOD ARM, HIGH BACK

W: 25.25" D: 26.25" H: 47.5" SW: 21" SD: 18" SH: 18" AH: 25" WT: 33 lb COM: 2.5 yd WT CAP: 500 lb

ZONE	B/COM	C	D	E	F	G	H	I	J	GENERAL INFORMATION
1	1879	1929	1977	2037	2137	2234	2334	2432	2532	MATERIAL: Beech MOIS. BARR: \$30
2	1925	1975	2023	2083	2183	2280	2380	2478	2578	
3	1971	2021	2069	2129	2229	2326	2426	2524	2624	
4	2017	2067	2115	2175	2275	2372	2472	2570	2670	

68MN30F OTTOMAN, WOOD

W: 19.25 D: 12.25 H: 11.5 SW: - SD: - SH: - AH: - WT: 16 COM: .5 yd WT CAP: -

ZONE	B/COM	C	D	E	F	G	H	I	J	GENERAL INFORMATION
1	968	978	988	1000	1020	1039	1059	1079	1099	MATERIAL: Beech MOIS. BARR: \$6
2	992	1002	1012	1024	1044	1063	1083	1103	1123	
3	1016	1026	1036	1048	1068	1087	1107	1127	1147	
4	1040	1050	1060	1072	1092	1111	1131	1151	1171	



68MN01MR FLEX BACK CHAIR, WOOD ARM

W: 25.25" D: 27.5" H: 33.75" SW: 21" SD: 18" SH: 18" AH: 25" WT: 30 lb COM: 1.75 yd WT CAP: 500 lb

ZONE	B/COM	C	D	E	F	G	H	I	J	GENERAL INFORMATION
1	2314	2349	2382	2424	2494	2563	2633	2701	2771	MATERIAL: Beech MOIS. BARR: \$21
2	2371	2406	2439	2481	2551	2620	2690	2758	2828	
3	2428	2463	2496	2538	2608	2677	2747	2815	2885	
4	2485	2520	2553	2595	2665	2734	2804	2872	2942	

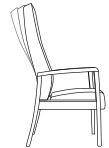

68MN01HR FLEX BACK CHAIR, WOOD ARM, HIGH BACK

W: 25.25" D: 27.5" H: 47.5" SW: 21" SD: 18" SH: 18" AH: 25" WT: 35 lb COM: 2.5 yd WT CAP: 500 lb

ZONE	B/COM	C	D	E	F	G	H	I	J	GENERAL INFORMATION
1	2886	2936	2984	3044	3144	3241	3341	3439	3539	MATERIAL: Beech MOIS. BARR: \$30
2	2957	3007	3055	3115	3215	3312	3412	3510	3610	
3	3028	3078	3126	3186	3286	3383	3483	3581	3681	
4	3099	3149	3197	3257	3357	3454	3554	3652	3752	

Accessories

URETHANE ARM CAPS

\$140 2 Arms

Available in black only.

Specify:

- Product Number
- Wood Finish
- Fabric Vendor,
Pattern and Color

See pages 16 & 17
for material and finish
options.

Monroe Freestanding Tables



68MN2424SQ FREESTANDING END TABLE, 24"

W: 24" D: 24" H: 18" WT: 47 lb

GENERAL INFORMATION

MATERIAL: Beech
MOIS. BARR: -

Zone	1	2	3	4
	1381	1416	1450	1485

Laminate top with wood base, see edge styles below.



68MN2448RE FREESTANDING COFFEE TABLE, RECTANGULAR

W: 48" D: 24" H: 18" WT: 64 lb

GENERAL INFORMATION

MATERIAL: Beech
MOIS. BARR: -

Zone	1	2	3	4
	1628	1669	1709	1750

Laminate top with wood base, see edge styles below.



68MN3030SQ FREESTANDING END TABLE, 30"

W: 30" D: 30" H: 18" WT: 57 lb

GENERAL INFORMATION

MATERIAL: Beech
MOIS. BARR: -

Zone	1	2	3	4
	1546	1585	1623	1662

Laminate top with wood base, see edge styles below.



68MN22DIA FREESTANDING END TABLE, ROUND

W: 22" D: 22" H: 18" WT: 47 lb

GENERAL INFORMATION

MATERIAL: Beech
MOIS. BARR: -

Zone	1	2	3	4
	1616	1656	1697	1737

Laminate top with wood base, see edge styles below.

Edge Style Options



FLAT PVC EDGE

Available in 7 colors to match metal finishes.



SELF EDGE

Matches top laminate.



2MM BIO EDGE

Available in 7 colors to match metal finishes.



2MM PVC WOOD GRAIN EDGE

Available in 9 wood grain colors to match standard laminates.

Specify:

- Product Number
- Wood Finish
- Laminate Vendor, Pattern and Finish
- Edge Profile

See pages 16 & 17 for material and finish options.

Monroe Modular Tables



68MNRC2828 CORNER TABLE, RADIUS, MODULAR

W: 28" D: 28" H: 18" WT: 42 lb

Zone	1	2	3	4
	1276	1308	1340	1372

GENERAL INFORMATION

MATERIAL: Laminate
MOIS. BARR: -

Modular table orders must include a layout to ensure proper configuration.



68MNSC2828 CORNER TABLE, SQUARE, MODULAR

W: 28" D: 28" H: 18" WT: 46 lb

Zone	1	2	3	4
	1393	1428	1463	1497

GENERAL INFORMATION

MATERIAL: Laminate
MOIS. BARR: -

Modular table orders must include a layout to ensure proper configuration.



68MNTC45DEG CORNER TABLE, ANGLED, MODULAR

W: - D: - H: 18" WT: 40 lb

Zone	1	2	3	4
	1276	1308	1340	1372

GENERAL INFORMATION

MATERIAL: Laminate
MOIS. BARR: -

Modular table orders must include a layout to ensure proper configuration.



68MNST2124 SPANNER TABLE, MODULAR

W: 24" D: 21" H: 18" WT: 27 lb

Zone	1	2	3	4
	864	886	907	929

GENERAL INFORMATION

MATERIAL: Laminate
MOIS. BARR: -

Modular table orders must include a layout to ensure proper configuration.



68MNET2124 END TABLE, MODULAR

W: 24" D: 21" H: 18" WT: 37 lb

Zone	1	2	3	4
	1155	1184	1213	1242

GENERAL INFORMATION

MATERIAL: Laminate
MOIS. BARR: -

Modular table orders must include a layout to ensure proper configuration.

Edge Style Options



FLAT PVC EDGE

Available in 7 colors to match metal finishes.



SELF EDGE

Matches top laminate.



2MM BIO EDGE

Available in 7 colors to match metal finishes.



2MM PVC WOOD GRAIN EDGE

Available in 9 wood grain colors to match standard laminates.

Specify:

- Product Number
- Laminate Vendor, Pattern and Finish
- Edge Profile

See pages 16 & 17 for material and finish options.



7029201 RESIN FOLDING CHAIR, UPH SEAT AND BACK, STACKING

W: 20" D: 22.75" H: 32.5" SW: 17.25" SD: 18" SH: 18" AH: - WT: 15 COM: .5 yd WT CAP: 400 lb

ZONE	B/COM	C	D	E	F	G	H	I	J	GENERAL INFORMATION
1	883	893	903	915	935	954	974	994	1014	MATERIAL: Resin MOIS. BARR: \$6
2	905	915	925	937	957	976	996	1016	1036	
3	927	937	947	959	979	998	1018	1038	1058	
4	949	959	969	981	1001	1020	1040	1060	1080	

Available in one color only, oyster. Deduct \$65 when standard poly under seat panel is not included. COM yardage is 0.7 yards if quantity is 5 or less.

Accessories



7034126 DOLLY FOR FOLDING CHAIRS

W: 21" D: 49" H: 53" WT: 63 lb
 Zone 1 Zone 2 Zone 3 Zone 4
 \$1335 \$1368 \$1402 \$1435

Dolly extension (7034003) is available. Chairs stack 16 high with the dolly and 20 high with the dolly extension.

7034003 DOLLY EXTENSION

W: 21" D: 49" H: 65" WT: 63 lb
 \$288

7170003 SMARTRAIL®

W: 23.5" D: 3" H: 5" WT: 3 lb
 \$207



No additional hardware is needed. SmartRail® requires no additional hardware to hang the chair. All wall fasteners are included with the SmartRail®.

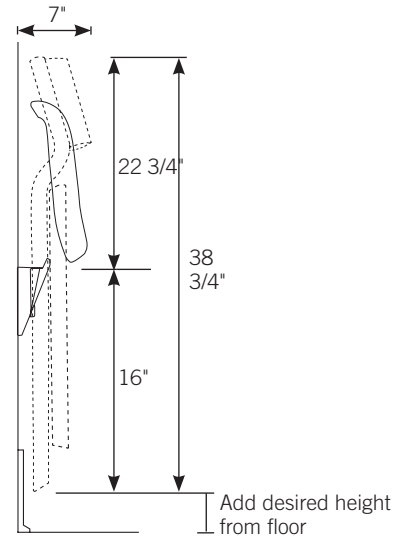

Specify:

- Product Number
- Fabric Vendor, Pattern and Color

See pages 16 & 17 for material and finish options.



7028201 FOLDING CHAIR, UPH SEAT AND BACK, WOOD BACKSIDE, STACKING

W: 19" D: 22.75" H: 32.5" SW: 16.25" SD: 18" SH: 18" AH: - WT: 15 lb COM: .5 yd WT CAP: 400 lb

ZONE	B/COM	C	D	E	F	G	H	I	J	GENERAL INFORMATION
1	760	770	780	792	812	831	851	871	891	MATERIAL: Beech
2	779	789	799	811	831	850	870	890	910	MOIS. BARR: \$6
3	798	808	818	830	850	869	889	909	929	
4	816	826	836	848	868	887	907	927	947	

Price includes Plastitack glides. Back edge wall guard is standard. COM yardage is 0.7 yards if quantity is 5 or less.



7028202 FOLDING CHAIR, UPH SEAT AND BACK, WOOD BACKSIDE, 2" WIDER, STACKING

W: 21" D: 22.75" H: 32.5" SW: 18.25" SD: 18" SH: 18" AH: - WT: 15 lb COM: .5 yd WT CAP: 400 lb

ZONE	B/COM	C	D	E	F	G	H	I	J	GENERAL INFORMATION
1	782	792	802	814	834	853	873	893	913	MATERIAL: Beech
2	801	811	821	833	853	872	892	912	932	MOIS. BARR: \$6
3	821	831	841	853	873	892	912	932	952	
4	840	850	860	872	892	911	931	951	971	

Price includes Plastitack glides. Back edge wall guard is standard. COM yardage is 0.7 yards if quantity is 5 or less.



7028204 FOLDING CHAIR, UPH SEAT, WOOD BACK, STACKING

W: 19" D: 22.75" H: 32.5" SW: 16.25" SD: 18" SH: 18" AH: - WT: 15 lb COM: .4 yd WT CAP: 400 lb

ZONE	B/COM	C	D	E	F	G	H	I	J	GENERAL INFORMATION
1	826	834	842	852	868	883	899	915	931	MATERIAL: Beech
2	846	854	862	872	888	903	919	935	951	MOIS. BARR: \$5
3	867	875	883	893	909	924	940	956	972	
4	888	896	904	914	930	945	961	977	993	

Price includes Plastitack glides. Not available with back edge wall guard. COM yardage is 0.7 yards if quantity is 5 or less.



7023201 FOLDING CHAIR, WOOD SEAT, WOOD BACK, STACKING

W: 19" D: 22.75" H: 32.5" SW: 16.25" SD: 18" SH: 18" AH: - WT: 15 lb COM: - WT CAP: 400 lb

Zone	1	2	3	4	GENERAL INFORMATION
	888	910	932	955	MATERIAL: Beech
					MOIS. BARR: -

Price includes Plastitack glides. Not available with back edge wall guard.

Specify:

- Product Number
- Wood Finish
- Fabric Vendor, Pattern and Color

See pages 16 & 17 for material and finish options.

Accessories



7100001 LASER CUT

\$69 per chair
 \$299 set up charge per design
 See Ordering Information for Laser Cut information.



7100002 LASER CUT WITH COLOR FILL

\$93 per chair
 \$299 set up charge per design
 See Ordering Information for Laser Cut information.

CUSTOM CNC BACK ROUT

\$62 per chair
 \$815 set up charge per design
 See Ordering Information.



7190004 UNDERSEAT PANEL, PLYFOLD STANDARD WIDTH

W: 18" D: 19" WT: 1 lb Beech
 \$90

Panels with vinyl or crypton upholstered seats will be drilled for ventilation. Not available for chairs with all-wood seats.



7190012 UNDERSEAT PANEL, PLYFOLD WIDER WIDTH

W: 18" D: 19" WT: 1 lb Beech
 \$96

Panels with vinyl or crypton upholstered seats will be drilled for ventilation. Not available for chairs with all-wood seats.

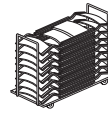

7034126 DOLLY FOR FOLDING CHAIRS

W: 21"	D: 49"	H: 53"	WT: 63 lb
Zone 1	Zone 2	Zone 3	Zone 4
\$1335	\$1368	\$1402	\$1435

Dolly extension (7034003) is available. Chairs stack 16 high with the dolly and 20 high with the dolly extension.



7034127 DOLLY FOR FOLDING CHAIRS, 2" WIDER

W: 23"	D: 49"	H: 53"	WT: 63 lb
Zone 1	Zone 2	Zone 3	Zone 4
\$1358	\$1392	\$1426	\$1460

Dolly extension (7034003) is available. Chairs stack 16 high with the dolly and 20 high with the dolly extension.

7034003 DOLLY EXTENSION

W: 21" D: 49" H: 65" WT: 63 lb
 \$288

7170003 SMARTRAIL

W: 23.5" D: 3" H: 5" WT: 3 lb
 \$207

No additional hardware is needed. SmartRail requires no additional hardware to hang the chair. All wall fasteners are included with the SmartRail.

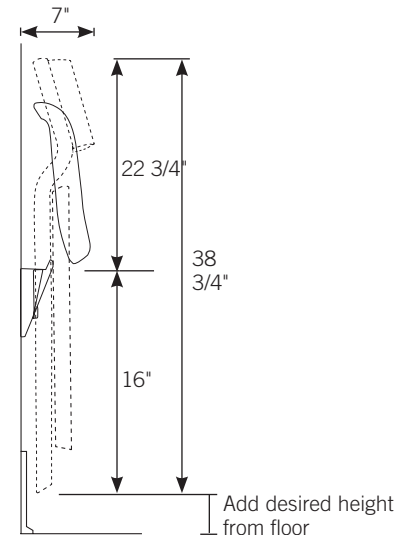

PlyLok Upholstered Seat



7028742 SIDE CHAIR, UPH SEAT, STACKING

W: 20" D: 22.25" H: 32.75" SW: 16.75" SD: 17.5" SH: 18" AH: - WT: 18 lb COM: .8 yd WT CAP: 750 lb

ZONE	B/COM	C	D	E	F	G	H	I	J	GENERAL INFORMATION
1	577	593	608	627	659	690	722	754	786	MATERIAL: Beech MOIS. BARR: \$10 2" SEAT FOAM: \$26
2	591	607	622	641	673	704	736	768	800	
3	605	621	636	655	687	718	750	782	814	
4	619	635	650	669	701	732	764	796	828	

Price includes Chrome Rubber cushioned glides. Plylok chairs without arms stack 8 high. Multiple back style options are available at no additional charge, refer to Back Styles section for more details when ordering.



7028744 SIDE CHAIR, UPH SEAT, 2" NARROWER, STACKING

W: 18" D: 22" H: 32.25" SW: 16.75" SD: 17.5" SH: 18" AH: - WT: 18 lb COM: .8 yd WT CAP: 750 lb

ZONE	B/COM	C	D	E	F	G	H	I	J	GENERAL INFORMATION
1	577	593	608	627	659	690	722	754	786	MATERIAL: Beech MOIS. BARR: \$10 2" SEAT FOAM: \$26
2	591	607	622	641	673	704	736	768	800	
3	605	621	636	655	687	718	750	782	814	
4	619	635	650	669	701	732	764	796	828	

Price includes Chrome Rubber cushioned glides. Plylok chairs without arms stack 8 high. Multiple back style options are available at no additional charge, refer to Back Styles section for more details when ordering.



7028749 SIDE CHAIR, UPH SEAT, 2" WIDER, STACKING

W: 22.25" D: 23" H: 33.75" SW: 18.75" SD: 17.5" SH: 18" AH: - WT: 20 lb COM: .9 yd WT CAP: 750 lb

ZONE	B/COM	C	D	E	F	G	H	I	J	GENERAL INFORMATION
1	624	642	660	681	717	752	788	823	859	MATERIAL: Beech MOIS. BARR: \$11 2" SEAT FOAM: \$26
2	639	657	675	696	732	767	803	838	874	
3	654	672	690	711	747	782	818	853	889	
4	670	688	706	727	763	798	834	869	905	

Price includes Chrome Rubber cushioned glides. Plylok chairs without arms stack 8 high. Multiple back style options are available at no additional charge, refer to Back Styles section for more details when ordering.



7328748 ARM CHAIR, UPH SEAT, STACKING

W: 24" D: 22.25" H: 32.75" SW: 16.75" SD: 17.5" SH: 18" AH: 25" WT: 22 lb COM: .8 yd WT CAP: 750 lb

ZONE	B/COM	C	D	E	F	G	H	I	J	GENERAL INFORMATION
1	772	788	803	822	854	885	917	949	981	MATERIAL: Beech MOIS. BARR: \$10 2" SEAT FOAM: \$26
2	791	807	822	841	873	904	936	968	1000	
3	810	826	841	860	892	923	955	987	1019	
4	829	845	860	879	911	942	974	1006	1038	

Price includes Chrome Rubber cushioned glides. Plylok arm chairs stack 7 high. Multiple back style options are available at no additional charge, refer to Back Styles section for more details when ordering.



7328749 ARM CHAIR, UPH SEAT, 2" WIDER, STACKING

W: 26.25" D: 23" H: 33.75" SW: 18.75" SD: 17.5" SH: 18" AH: - WT: 24 lb COM: .9 yd WT CAP: 750 lb

ZONE	B/COM	C	D	E	F	G	H	I	J	GENERAL INFORMATION
1	819	837	855	876	912	947	983	1018	1054	MATERIAL: Beech MOIS. BARR: \$11 2" SEAT FOAM: \$26
2	839	857	875	896	932	967	1003	1038	1074	
3	859	877	895	916	952	987	1023	1058	1094	
4	879	897	915	936	972	1007	1043	1078	1114	

Price includes Chrome Rubber cushioned glides. Plylok arm chairs stack 7 high. Multiple back style options are available at no additional charge, refer to Back Styles section for more details when ordering.



7028843 SLEDBASE CHAIR, UPH SEAT, NON-STACKING

W: 20" D: 22.25" H: 32.5" SW: 16.75" SD: 17.5" SH: 18" AH: - WT: 23 lb COM: .8 yd WT CAP: 750 lb

ZONE	B/COM	C	D	E	F	G	H	I	J	GENERAL INFORMATION
1	684	700	715	734	766	797	829	861	893	MATERIAL: Beech MOIS. BARR: \$10 2" SEAT FOAM: \$26
2	701	717	732	751	783	814	846	878	910	
3	718	734	749	768	800	831	863	895	927	
4	734	750	765	784	816	847	879	911	943	

Multiple back style options are available at no additional charge, refer to Back Styles section for more details when ordering.

- Specify:
- Product Number
 - Wood Finish
 - Back Style
 - Fabric Vendor, Pattern and Color

See pages 16 & 17 for material and finish options.

PlyLok Wood Seat



7023711 SIDE CHAIR, WOOD SEAT, STACKING

W: 20" D: 22.25" H: 33.75" SW: 16.75" SD: 17.25" SH: 18" AH: - WT: 19 lb COM: .5 yd WT CAP: 750 lb

ZONE	B/COM	C	D	E	F	G	H	I	J	GENERAL INFORMATION
1	570	580	590	602	622	641	661	681	701	MATERIAL: Beech
2	584	594	604	616	636	655	675	695	715	MOIS. BARR: -
3	598	608	618	630	650	669	689	709	729	
4	612	622	632	644	664	683	703	723	743	

Price includes Chrome Rubber cushioned glides. Plylok chairs without arms stack 8 high. Multiple back style options are available at no additional charge, refer to Back Styles section for more details when ordering.



7023712 SIDE CHAIR, WOOD SEAT, 2" NARROWER, STACKING

W: 18" D: 22" H: 33.25" SW: 14.75" SD: 17.25" SH: 18" AH: - WT: 18 lb COM: .5 yd WT CAP: 750 lb

ZONE	B/COM	C	D	E	F	G	H	I	J	GENERAL INFORMATION
1	570	580	590	602	622	641	661	681	701	MATERIAL: Beech
2	584	594	604	616	636	655	675	695	715	MOIS. BARR: -
3	598	608	618	630	650	669	689	709	729	
4	612	622	632	644	664	683	703	723	743	

Price includes Chrome Rubber cushioned glides. Plylok chairs without arms stack 8 high. Multiple back style options are available at no additional charge, refer to Back Styles section for more details when ordering.



7023715 SLEDBASE CHAIR, WOOD SEAT, NON-STACKING

W: 20" D: 22.25" H: 33.5" SW: 16.75" SD: 17.25" SH: 18" AH: - WT: 24 lb COM: .5 yd WT CAP: 750 lb

ZONE	B/COM	C	D	E	F	G	H	I	J	GENERAL INFORMATION
1	679	689	699	711	731	750	770	790	810	MATERIAL: Beech
2	696	706	716	728	748	767	787	807	827	MOIS. BARR: -
3	713	723	733	745	765	784	804	824	844	
4	729	739	749	761	781	800	820	840	860	

Multiple back style options are available at no additional charge, refer to Back Styles section for more details when ordering. Nonstacking.



7323718 ARM CHAIR, WOOD SEAT, STACKING

W: 24" D: 22.25" H: 33.75" SW: 16.75" SD: 17.25" SH: 18" AH: 25" WT: 23 lb COM: .5 yd WT CAP: 750 lb

ZONE	B/COM	C	D	E	F	G	H	I	J	GENERAL INFORMATION
1	765	775	785	797	817	836	856	876	896	MATERIAL: Beech
2	784	794	804	816	836	855	875	895	915	MOIS. BARR: -
3	803	813	823	835	855	874	894	914	934	
4	822	832	842	854	874	893	913	933	953	

Price includes Chrome Rubber cushioned glides. Plylok arm chairs stack 7 high. Multiple back style options are available at no additional charge, refer to Back Styles section for more details when ordering.



7323719 ARM CHAIR, WOOD SEAT, 2" WIDER, STACKING

W: 26.25" D: 23" H: 33.75" SW: 18.75" SD: 17.25" SH: 18" AH: 25" WT: 25 lb COM: .5 yd WT CAP: 750 lb

ZONE	B/COM	C	D	E	F	G	H	I	J	GENERAL INFORMATION
1	798	808	818	830	850	869	889	909	929	MATERIAL: Beech
2	818	828	838	850	870	889	909	929	949	MOIS. BARR: -
3	838	848	858	870	890	909	929	949	969	
4	857	867	877	889	909	928	948	968	988	

Price includes Chrome Rubber cushioned glides. Plylok arm chairs stack 7 high. Multiple back style options are available at no additional charge, refer to Back Styles section for more details when ordering.

Specify:

- Product Number
- Wood Finish
- Back Style
- Fabric Vendor, Pattern and Color

See pages 16 & 17 for material and finish options.

PlyLok Bar Stools, Counter Stools



7128744 BAR STOOL, UPH SEAT

W: 17.5" D: 23" H: 43.25" SW: 16.75" SD: 17.5" SH: 29" AH: - WT: 21 lb COM: .8 yd WT CAP: 750 lb

ZONE	B/COM	C	D	E	F	G	H	I	J	GENERAL INFORMATION
1	1066	1082	1097	1116	1148	1179	1211	1243	1275	MATERIAL: Beech MOIS. BARR: \$10 2" SEAT FOAM: \$26
2	1092	1108	1123	1142	1174	1205	1237	1269	1301	
3	1119	1135	1150	1169	1201	1232	1264	1296	1328	
4	1145	1161	1176	1195	1227	1258	1290	1322	1354	

Price includes Chrome Rubber cushioned glides. Multiple back style options are available at no additional charge, refer to Back Styles section for more details when ordering.

7123712 BAR STOOL, WOOD SEAT

W: 17.5" D: 23" H: 43.25" SW: 16.75" SD: 17.25" SH: 28" AH: - WT: 23 lb COM: .5 yd WT CAP: 750 lb

ZONE	B/COM	C	D	E	F	G	H	I	J	GENERAL INFORMATION
1	1056	1066	1076	1088	1108	1127	1147	1167	1187	MATERIAL: Beech MOIS. BARR: -
2	1082	1092	1102	1114	1134	1153	1173	1193	1213	
3	1108	1118	1128	1140	1160	1179	1199	1219	1239	
4	1135	1145	1155	1167	1187	1206	1226	1246	1266	

Price includes Chrome Rubber cushioned glides. Multiple back style options are available at no additional charge, refer to Back Styles section for more details when ordering.



7228744 COUNTER STOOL, UPH SEAT

W: 17.5" D: 23" H: 38.25" SW: 16.75" SD: 17.5" SH: 24" AH: - WT: 20 lb COM: .8 yd WT CAP: 750 lb

ZONE	B/COM	C	D	E	F	G	H	I	J	GENERAL INFORMATION
1	1059	1075	1090	1109	1141	1172	1204	1236	1268	MATERIAL: Beech MOIS. BARR: \$10 2" SEAT FOAM: \$26
2	1085	1101	1116	1135	1167	1198	1230	1262	1294	
3	1111	1127	1142	1161	1193	1224	1256	1288	1320	
4	1137	1153	1168	1187	1219	1250	1282	1314	1346	

Price includes Chrome Rubber cushioned glides. Multiple back style options are available at no additional charge, refer to Back Styles section for more details when ordering.

7223712 COUNTER STOOL, WOOD SEAT

W: 17.5" D: 23" H: 38.25" SW: 16.75" SD: 17.25" SH: 23" AH: - WT: 22 lb COM: .5 yd WT CAP: 750 lb

ZONE	B/COM	C	D	E	F	G	H	I	J	GENERAL INFORMATION
1	1051	1061	1071	1083	1103	1122	1142	1162	1182	MATERIAL: Beech MOIS. BARR: -
2	1077	1087	1097	1109	1129	1148	1168	1188	1208	
3	1103	1113	1123	1135	1155	1174	1194	1214	1234	
4	1129	1139	1149	1161	1181	1200	1220	1240	1260	

Price includes Chrome Rubber cushioned glides. Multiple back style options are available at no additional charge, refer to Back Styles section for more details when ordering.

Specify:

- Product Number
- Wood Finish
- Back Style
- Fabric Vendor, Pattern and Color

See pages 16 & 17 for material and finish options.

PlyLok Back Styles and Accessories

Back Styles

UPH FRONT AND BACK



UFUBS
SQUARE

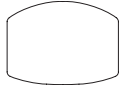

UFUBR
ROUND

UPH FRONT AND WOOD BACK



UFWBS
SQUARE**

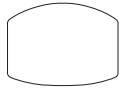

UFWBR
ROUND**

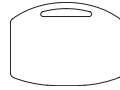

UFWBRH ROUND
W/HANDHOLD**

WOOD FRONT AND BACK



AWBS
SQUARE*

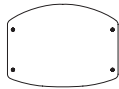

AWBR
ROUND*

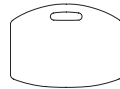

AWBRH ROUND
W/HANDHOLD*

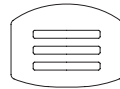

AWBL
LADDER

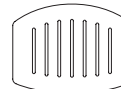

AWBM
MISSION

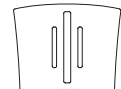

AWB3S
3-SLOT

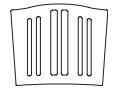

AWB6S
6-SLOT

*Custom CNC back rout and/or laser cut available.
** Laser cut available.

Accessories



7100001 LASER CUT

\$69 per chair
\$299 set up charge per design
See Ordering Information for Laser Cut information.



7100002 LASER CUT WITH COLOR FILL

\$93 per chair
\$299 set up charge per design
See Ordering Information for Laser Cut information.

CUSTOM CNC BACK ROUT

\$62 per chair
\$815 set up charge per design
See Ordering Information.



7032000 UNIVERSAL 2-WHEEL CART

WT: 37 lb

Zone 1	Zone 2	Zone 3	Zone 4
\$1028	\$1054	\$1079	\$1105

Cart holds 8 side chairs and 7 arm chairs.



7144014 T MOLD RUNNER (SET OF TWO)

\$39 WT: 0.5 lb
Available for 2- and 3-position and sledbase chairs.

EXTENDED SEAT PAD

\$62 per chair



7190005 UNDERSEAT WOOD PANEL

W: 18" D: 19" WT: 1 lb
\$90

Panels with vinyl or crypton upholstered seats will be drilled for ventilation. Available for standard width Plylok chairs only.



7190006 UNDERSEAT WOOD PANEL, 2" NARROWER MODELS

W: 18" D: 19" WT: 1 lb
\$90

Panels with vinyl or crypton upholstered seats will be drilled for ventilation. Available for 2" narrower Plylok chairs only.



7070011 2" PLASTIC LEG PROTECTOR (SET OF FOUR)

\$74



7070018 PLASTIC LEG PROTECTOR, CLEAR (SET OF TWO)

\$37



243144 COUNTER STOOL

W: 17.75" D: 20.25" H: 24" SW: 13" SD: - SH: - AH: - WT: 8 lb COM: .25 yd WT CAP: 300 lb

ZONE	B/COM	C	D	E	F	G	H	I	J	GENERAL INFORMATION
1	712	717	722	728	738	748	758	767	777	MATERIAL: Metal MOIS. BARR: -
2	730	735	740	746	756	766	776	785	795	
3	747	752	757	763	773	783	793	802	812	
4	765	770	775	781	791	801	811	820	830	



243147 BAR STOOL

W: 17.75" D: 20.5" H: 30" SW: 13" SD: - SH: - AH: - WT: 9 lb COM: .25 yd WT CAP: 300 lb

ZONE	B/COM	C	D	E	F	G	H	I	J	GENERAL INFORMATION
1	727	732	737	743	753	763	773	782	792	MATERIAL: Metal MOIS. BARR: -
2	745	750	755	761	771	781	791	800	810	
3	763	768	773	779	789	799	809	818	828	
4	781	786	791	797	807	817	827	836	846	

Specify:

- Product Number
- Metal Finish
- Fabric Vendor,
Pattern and Color



**See pages 16 & 17
for material and finish
options.**

Rally

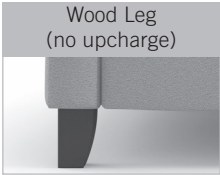
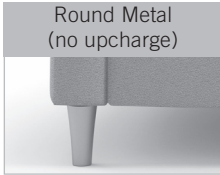
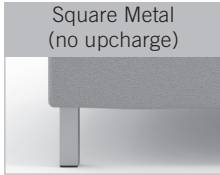
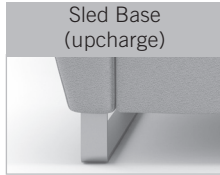
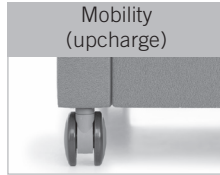
LEG OPTIONS – SEATING AND SQUARE OTTOMAN

 <p>Wood Leg (no upcharge)</p>	 <p>Round Metal (no upcharge)</p>	 <p>Square Metal (no upcharge)</p>	 <p>Sled Base (upcharge)</p>	 <p>Mobility (upcharge)</p>
<p><i>Metal feet available in silver color only.</i></p>			<p>\$239 Compose or Privacy Corner Loveseat \$180 Compose w/1 Arm \$357 Privacy Booth w/Table \$120 All Other Models <i>Not available on round ottomans. A layout is required if specifying on a corner unit.</i></p>	<p>\$574 Compose \$433 Compose w/1 Arm \$279 All Other Models <i>Not available on loveseat, sofa, or privacy models.</i></p>

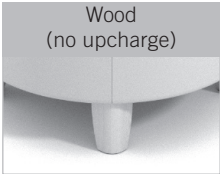
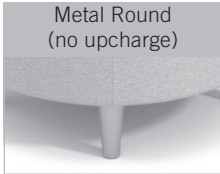
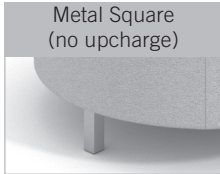
LEG OPTIONS – ROUND OTTOMANS

 <p>Wood (no upcharge)</p>	 <p>Metal Round (no upcharge)</p>	 <p>Metal Square (no upcharge)</p>	 <p>Sled Foot \$184</p>	 <p>Casters \$351</p>
<p><i>Metal feet available in silver color only.</i></p>			<p><i>5 per Ottoman.</i></p>	

ARM CAP OPTIONS

Arm Cap \$310 (pair)
\$155 (single)



Thermoform only. Only available on Embrace models.

ARM CAP OPTIONS

Back Cap \$105



\$276 Corner Unit
Not available on loveseat, sofa or mid-back models.

MID-BACK OPTIONS

Mid-back



\$152 Chair Models
\$307 Loveseat Models
\$456 Sofa Models
Overall height 35".

Mid-back Corner 64441 \$307



Overall height 35".
COM: 0.5 yd

Mid-back Wedge Inside \$218



Overall height 35".
COM: 0.25 yd

Mid-back Wedge Outside \$117



Overall height 35".
COM: 0.25 yd

Fabric zoning not recommended when using mid back with Indulge models.

OTTOMAN & TABLE TOP OTTOMANS OPTIONS

Upholstered (no upcharge)

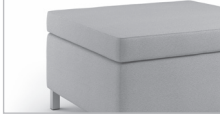

H: 18" WT: 47 lb

Standard Height



H: 16.25" WT: 75 lb
\$1382 Thermoform
\$1362 Laminate

Low Table Top Square



H: 15"
\$493 Thermoform
\$659 Laminate

Low Table Top Wedge



H: 18"
\$431 Thermoform
\$636 Laminate

Low Table Top Round

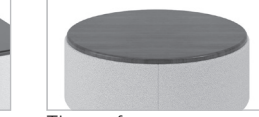

Thermoform:
22" 30" 36"
\$220 \$366 \$583
Laminate:
22" 30" 36"
\$333 \$535 \$797

LAMINATE TOP OPTIONS

Compose Arm \$538 (pair)
\$269 (single)



Thermoform comes standard (no upcharge).

Coffee Table Ottoman \$260



Integrated Table \$176



Round End Table Ottoman \$128



Low Table Top is standard on 22" Round End Table Ottoman (6422-ET-OT) without an upcharge. Upholstered top not available on 22" Round End Table Ottoman.

POWER OPTIONS

USB/120V Outlet \$759



OR

120V/120V Outlet \$641



USB/120V Double Outlet \$1518



OR

120V/120V Double Outlet \$1282



For chairs with table arm. Must specify black or silver. Cord length is 12'.

For Compose models with two table arms, wedge table and table top ottomans. Must specify black or silver. Cord length is 12'. Not available on Coffee Table Top Ottoman or Round Ottomans.

GANGING OPTION

\$69 Aspire and Indulge w/1 Arm

\$183 All other Chairs, Loveseats, Sofas and Wedge Ottomans

\$174 Square Ottomans

Rally Aspire



64331HC ASPIRE CHAIR

W: 34.25" D: 31" H: 31" SW: 23" SD: 21" SH: 18" AH: 26.5" WT: 62 lb COM: 6.25 yd WT CAP: 400 lb

ZONE	B/COM	C	D	E	F	G	H	I	J	GENERAL INFORMATION
1	3290	3415	3534	3684	3934	4178	4428	4671	4921	MATERIAL: Maple MOIS. BARR: Included
2	3370	3495	3614	3764	4014	4258	4508	4751	5001	
3	3450	3575	3694	3844	4094	4338	4588	4831	5081	
4	3529	3654	3773	3923	4173	4417	4667	4910	5160	

See beginning of section for details on standard and optional items and pricing. Cannot be ganged.



64131HC ASPIRE CHAIR WITH 1 UPH ARM

W: 28.75" D: 31" H: 31" SW: 23" SD: 21" SH: 18" AH: 26.5" WT: 49 lb COM: 5 yd WT CAP: 400 lb

ZONE	B/COM	C	D	E	F	G	H	I	J	GENERAL INFORMATION
1	3037	3137	3232	3352	3552	3747	3947	4142	4342	MATERIAL: Maple MOIS. BARR: Included
2	3111	3211	3306	3426	3626	3821	4021	4216	4416	
3	3185	3285	3380	3500	3700	3895	4095	4290	4490	
4	3259	3359	3454	3574	3774	3969	4169	4364	4564	

When ordering, specify arm location (right or left) as facing the unit. Please use code RA (right arm) or LA (left arm). Ganging is available. See beginning of section for details on standard and optional items and pricing.



64332HC ASPIRE LOVESEAT

W: 57.25" D: 31" H: 31" SW: 46" SD: 21" SH: 18" AH: 26.5" WT: 90 lb COM: 8.5 yd WT CAP: 600 lb

ZONE	B/COM	C	D	E	F	G	H	I	J	GENERAL INFORMATION
1	5105	5275	5437	5641	5981	6312	6652	6984	7324	MATERIAL: Maple MOIS. BARR: Included
2	5229	5399	5561	5765	6105	6436	6776	7108	7448	
3	5353	5523	5685	5889	6229	6560	6900	7232	7572	
4	5478	5648	5810	6014	6354	6685	7025	7357	7697	

See beginning of section for details on standard and optional items and pricing. Cannot be ganged.



64132HC ASPIRE LOVESEAT WITH 1 UPH ARM

W: 51.75" D: 31" H: 31" SW: 46" SD: 21" SH: 18" AH: 26.5" WT: 79 lb COM: 7.25 yd WT CAP: 600 lb

ZONE	B/COM	C	D	E	F	G	H	I	J	GENERAL INFORMATION
1	4856	5001	5139	5313	5603	5886	6176	6458	6748	MATERIAL: Maple MOIS. BARR: Included
2	4974	5119	5257	5431	5721	6004	6294	6576	6866	
3	5093	5238	5376	5550	5840	6123	6413	6695	6985	
4	5212	5357	5495	5669	5959	6242	6532	6814	7104	

When ordering, specify arm location (right or left) as facing the unit. Please use code RA (right arm) or LA (left arm). See beginning of section for details on standard and optional items and pricing. Ganging is available.

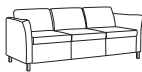

64333HC ASPIRE SOFA

W: 80.25" D: 31" H: 31" SW: 69" SD: 21" SH: 18" AH: 26.5" WT: 125 lb COM: 10.75 yd WT CAP: 700 lb

ZONE	B/COM	C	D	E	F	G	H	I	J	GENERAL INFORMATION
1	6585	6800	7004	7262	7692	8112	8542	8961	9391	MATERIAL: Maple MOIS. BARR: Included
2	6745	6960	7164	7422	7852	8272	8702	9121	9551	
3	6906	7121	7325	7583	8013	8433	8863	9282	9712	
4	7066	7281	7485	7743	8173	8593	9023	9442	9872	

See beginning of section for details on standard and optional items and pricing. Cannot be ganged.



64133HC ASPIRE SOFA WITH 1 UPH ARM

W: 74.75" D: 31" H: 31" SW: 69" SD: 21" SH: 18" AH: 26.5" WT: 114 lb COM: 9.5 yd WT CAP: 700 lb

ZONE	B/COM	C	D	E	F	G	H	I	J	GENERAL INFORMATION
1	6336	6526	6707	6935	7315	7685	8065	8436	8816	MATERIAL: Maple MOIS. BARR: Included
2	6491	6681	6862	7090	7470	7840	8220	8591	8971	
3	6645	6835	7016	7244	7624	7994	8374	8745	9125	
4	6800	6990	7171	7399	7779	8149	8529	8900	9280	

When ordering, specify arm location (right or left) as facing the unit. Please use code RA (right arm) or LA (left arm). Ganging is available. See beginning of section for details on standard and optional items and pricing.

Specify:

- Product Number
- Arm Location
- Fabric Vendor, Pattern and Color
- Leg Option
- Wood Option Only:
- Wood Finish

See pages 16 & 17 for material and finish options.

Rally Embrace



64311HC EMBRACE CHAIR

W: 30"	D: 31"	H: 31"	SW: 23"	SD: 21"	SH: 18"	AH: 26"	WT: 60 lb	COM: 6.25 yd	WT CAP: 400 lb	
ZONE	B/COM	C	D	E	F	G	H	I	J	GENERAL INFORMATION
1	3268	3393	3512	3662	3912	4156	4406	4649	4899	MATERIAL: Maple
2	3347	3472	3591	3741	3991	4235	4485	4728	4978	MOIS. BARR: Included
3	3426	3551	3670	3820	4070	4314	4564	4807	5057	
4	3506	3631	3750	3900	4150	4394	4644	4887	5137	

Ganging is available. See beginning of section for details on standard and optional items and pricing.



64111HC EMBRACE CHAIR WITH 1 UPH ARM

W: 26.5"	D: 31"	H: 31"	SW: 23"	SD: 21"	SH: 18"	AH: 26"	WT: 49 lb	COM: 4.75 yd	WT CAP: 400 lb	
ZONE	B/COM	C	D	E	F	G	H	I	J	GENERAL INFORMATION
1	3009	3104	3194	3308	3498	3684	3874	4059	4249	MATERIAL: Maple
2	3082	3177	3267	3381	3571	3757	3947	4132	4322	MOIS. BARR: Included
3	3156	3251	3341	3455	3645	3831	4021	4206	4396	
4	3229	3324	3414	3528	3718	3904	4094	4279	4469	

When ordering, specify arm location (right or left) as facing the unit. Please use code RA (right arm) or LA (left arm). Ganging is available. See beginning of section for details on standard and optional items and pricing.



64312HC EMBRACE LOVESEAT

W: 53"	D: 31"	H: 31"	SW: 46"	SD: 21"	SH: 18"	AH: 26"	WT: 96 lb	COM: 8.5 yd	WT CAP: 600 lb	
ZONE	B/COM	C	D	E	F	G	H	I	J	GENERAL INFORMATION
1	5071	5241	5403	5607	5947	6278	6618	6950	7290	MATERIAL: Maple
2	5194	5364	5526	5730	6070	6401	6741	7073	7413	MOIS. BARR: Included
3	5318	5488	5650	5854	6194	6525	6865	7197	7537	
4	5441	5611	5773	5977	6317	6648	6988	7320	7660	

Ganging is available. See beginning of section for details on standard and optional items and pricing.



64112HC EMBRACE LOVESEAT WITH 1 UPH ARM

W: 49.5"	D: 31"	H: 31"	SW: 46"	SD: 21"	SH: 18"	AH: 26"	WT: 82 lb	COM: 6.75 yd	WT CAP: 600 lb	
ZONE	B/COM	C	D	E	F	G	H	I	J	GENERAL INFORMATION
1	4815	4955	5088	5256	5536	5809	6089	6362	6642	MATERIAL: Maple
2	4933	5073	5206	5374	5654	5927	6207	6480	6760	MOIS. BARR: Included
3	5050	5190	5323	5491	5771	6044	6324	6597	6877	
4	5168	5308	5441	5609	5889	6162	6442	6715	6995	

When ordering, specify arm location (right or left) as facing the unit. Please use code RA (right arm) or LA (left arm). Ganging is available. See beginning of section for details on standard and optional items and pricing.



64313HC EMBRACE SOFA

W: 76"	D: 31"	H: 31"	SW: 69"	SD: 21"	SH: 18"	AH: 26"	WT: 131 lb	COM: 10.75 yd	WT CAP: 700 lb	
ZONE	B/COM	C	D	E	F	G	H	I	J	GENERAL INFORMATION
1	6538	6753	6957	7215	7645	8065	8495	8914	9344	MATERIAL: Maple
2	6697	6912	7116	7374	7804	8224	8654	9073	9503	MOIS. BARR: Included
3	6856	7071	7275	7533	7963	8383	8813	9232	9662	
4	7015	7230	7434	7692	8122	8542	8972	9391	9821	

Ganging is available. See beginning of section for details on standard and optional items and pricing.



64113HC EMBRACE SOFA WITH 1 UPH ARM

W: 72.5"	D: 31"	H: 31"	SW: 69"	SD: 21"	SH: 18"	AH: 26"	WT: 117 lb	COM: 9.25 yd	WT CAP: 700 lb	
ZONE	B/COM	C	D	E	F	G	H	I	J	GENERAL INFORMATION
1	6282	6467	6643	6865	7235	7596	7966	8326	8696	MATERIAL: Maple
2	6435	6620	6796	7018	7388	7749	8119	8479	8849	MOIS. BARR: Included
3	6589	6774	6950	7172	7542	7903	8273	8633	9003	
4	6742	6927	7103	7325	7695	8056	8426	8786	9156	

When ordering, specify arm location (right or left) as facing the unit. Please use code RA (right arm) or LA (left arm). Ganging is available. See beginning of section for details on standard and optional items and pricing.

Specify:

Product Number

Arm Location

Fabric Vendor, Pattern and Color

Leg Option

Wood Option Only:

Wood Finish

See pages 16 & 17 for material and finish options.

Rally Indulge



64321HC INDULGE CHAIR

W: 34" D: 31" H: 31" SW: 23" SD: 21" SH: 18" AH: 23.5" WT: 60 lb COM: 5.5 yd WT CAP: 400 lb

ZONE	B/COM	C	D	E	F	G	H	I	J	GENERAL INFORMATION
1	3256	3366	3471	3603	3823	4037	4257	4472	4692	MATERIAL: Maple
2	3335	3445	3550	3682	3902	4116	4336	4551	4771	MOIS. BARR: Included
3	3414	3524	3629	3761	3981	4195	4415	4630	4850	
4	3494	3604	3709	3841	4061	4275	4495	4710	4930	

Cannot be ganged. See beginning of section for details on standard and optional items and pricing.



64121HC INDULGE CHAIR WITH 1 UPH ARM

W: 28.5" D: 31" H: 31" SW: 23" SD: 21" SH: 18" AH: 23.5" WT: 49 lb COM: 4.5 yd WT CAP: 400 lb

ZONE	B/COM	C	D	E	F	G	H	I	J	GENERAL INFORMATION
1	3005	3095	3181	3289	3469	3644	3824	4000	4180	MATERIAL: Maple
2	3078	3168	3254	3362	3542	3717	3897	4073	4253	MOIS. BARR: Included
3	3152	3242	3328	3436	3616	3791	3971	4147	4327	
4	3225	3315	3401	3509	3689	3864	4044	4220	4400	

When ordering, specify arm location (right or left) as facing the unit. Please use code RA (right arm) or LA (left arm). Ganging is available. See beginning of section for details on standard and optional items and pricing.



64322HC INDULGE LOVESEAT

W: 57" D: 31" H: 31" SW: 46" SD: 21" SH: 18" AH: 23.5" WT: 94 lb COM: 8.25 yd WT CAP: 600 lb

ZONE	B/COM	C	D	E	F	G	H	I	J	GENERAL INFORMATION
1	5063	5223	5375	5567	5887	6199	6519	6831	7151	MATERIAL: Maple
2	5186	5346	5498	5690	6010	6322	6642	6954	7274	MOIS. BARR: Included
3	5310	5470	5622	5814	6134	6446	6766	7078	7398	
4	5433	5593	5745	5937	6257	6569	6889	7201	7521	

Cannot be ganged. See beginning of section for details on standard and optional items and pricing.



64122HC INDULGE LOVESEAT WITH 1 UPH ARM

W: 51.5" D: 31" H: 31" SW: 46" SD: 21" SH: 18" AH: 23.5" WT: 81 lb COM: 6.75 yd WT CAP: 600 lb

ZONE	B/COM	C	D	E	F	G	H	I	J	GENERAL INFORMATION
1	4815	4955	5088	5256	5536	5809	6089	6362	6642	MATERIAL: Maple
2	4933	5073	5206	5374	5654	5927	6207	6480	6760	MOIS. BARR: Included
3	5050	5190	5323	5491	5771	6044	6324	6597	6877	
4	5168	5308	5441	5609	5889	6162	6442	6715	6995	

When ordering, specify arm location (right or left) as facing the unit. Please use code RA (right arm) or LA (left arm). Ganging is available. See beginning of section for details on standard and optional items and pricing.



64323HC INDULGE SOFA

W: 80" D: 31" H: 31" SW: 69" SD: 21" SH: 18" AH: 23.5" WT: 129 lb COM: 10.25 yd WT CAP: 700 lb

ZONE	B/COM	C	D	E	F	G	H	I	J	GENERAL INFORMATION
1	6530	6735	6930	7176	7586	7986	8396	8795	9205	MATERIAL: Maple
2	6689	6894	7089	7335	7745	8145	8555	8954	9364	MOIS. BARR: Included
3	6848	7053	7248	7494	7904	8304	8714	9113	9523	
4	7007	7212	7407	7653	8063	8463	8873	9272	9682	

Cannot be ganged. See beginning of section for details on standard and optional items and pricing.



64123HC INDULGE SOFA WITH 1 UPH ARM

W: 74.5" D: 31" H: 31" SW: 69" SD: 21" SH: 18" AH: 23.5" WT: 116 lb COM: 9.25 yd WT CAP: 700 lb

ZONE	B/COM	C	D	E	F	G	H	I	J	GENERAL INFORMATION
1	6282	6467	6643	6865	7235	7596	7966	8326	8696	MATERIAL: Maple
2	6435	6620	6796	7018	7388	7749	8119	8479	8849	MOIS. BARR: Included
3	6589	6774	6950	7172	7542	7903	8273	8633	9003	
4	6742	6927	7103	7325	7695	8056	8426	8786	9156	

When ordering, specify arm location (right or left) as facing the unit. Please use code RA (right arm) or LA (left arm). Ganging is available. See beginning of section for details on standard and optional items and pricing.

Specify:

- Product Number
- Arm Location
- Fabric Vendor, Pattern and Color
- Leg Option
- Wood Option Only:
 - Wood Finish

See pages 16 & 17 for material and finish options.

Rally Compose



64341HC COMPOSE CHAIR

W: 46" D: 31" H: 31" SW: 23" SD: 21" SH: 18" AH: 26" WT: 116 lb COM: 6.25 yd WT CAP: 400 lb

ZONE	B/COM	C	D	E	F	G	H	I	J	GENERAL INFORMATION
1	6082	6207	6326	6476	6726	6970	7220	7463	7713	MATERIAL: Maple
2	6232	6357	6476	6626	6876	7120	7370	7613	7863	MOIS. BARR: Included
3	6381	6506	6625	6775	7025	7269	7519	7762	8012	
4	6531	6656	6775	6925	7175	7419	7669	7912	8162	

Specify material and finish when ordering. Ganging is available. Power is available on both arms. See beginning of section for details on standard and optional items and pricing.

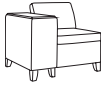

64141HC COMPOSE CHAIR WITH 1 TABLE ARM

W: 34.5" D: 31" H: 31" SW: 23" SD: 21" SH: 18" AH: 26" WT: 77 lb COM: 4.75 yd WT CAP: 400 lb

ZONE	B/COM	C	D	E	F	G	H	I	J	GENERAL INFORMATION
1	4157	4252	4342	4456	4646	4832	5022	5207	5397	MATERIAL: Maple
2	4259	4354	4444	4558	4748	4934	5124	5309	5499	MOIS. BARR: Included
3	4361	4456	4546	4660	4850	5036	5226	5411	5601	
4	4463	4558	4648	4762	4952	5138	5328	5513	5703	

When ordering, specify table arm location (right or left) as facing the unit. Please use code LT (left table) or RT (right table). Specify material and finish when ordering. Ganging is available. Power is available. See beginning of section for details on standard and optional items and pricing.



64342HC COMPOSE LOVESEAT

W: 69" D: 31" H: 31" SW: 46" SD: 21" SH: 18" AH: 26" WT: 120 lb COM: 8.5 yd WT CAP: 600 lb

ZONE	B/COM	C	D	E	F	G	H	I	J	GENERAL INFORMATION
1	7177	7347	7509	7713	8053	8384	8724	9056	9396	MATERIAL: Maple
2	7353	7523	7685	7889	8229	8560	8900	9232	9572	MOIS. BARR: Included
3	7529	7699	7861	8065	8405	8736	9076	9408	9748	
4	7705	7875	8037	8241	8581	8912	9252	9584	9924	

Specify material and finish when ordering. Ganging is available. Power is available. See beginning of section for details on standard and optional items and pricing.



64142HC COMPOSE LOVESEAT WITH 1 TABLE ARM

W: 57.5" D: 31" H: 31" SW: 46" SD: 21" SH: 18" AH: 26" WT: 94 lb COM: 7 yd WT CAP: 600 lb

ZONE	B/COM	C	D	E	F	G	H	I	J	GENERAL INFORMATION
1	5289	5429	5562	5730	6010	6283	6563	6836	7116	MATERIAL: Maple
2	5418	5558	5691	5859	6139	6412	6692	6965	7245	MOIS. BARR: Included
3	5548	5688	5821	5989	6269	6542	6822	7095	7375	
4	5677	5817	5950	6118	6398	6671	6951	7224	7504	

When ordering, specify table arm location (right or left) as facing the unit. Please use code LT (left table) or RT (right table). Specify material and finish when ordering. Ganging is available. Power is available. See beginning of section for details on standard and optional items and pricing.

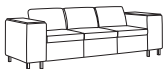

64343HC COMPOSE SOFA

W: 92" D: 31" H: 31" SW: 69" SD: 21" SH: 18" AH: 26" WT: 120 lb COM: 11 yd WT CAP: 700 lb

ZONE	B/COM	C	D	E	F	G	H	I	J	GENERAL INFORMATION
1	8178	8398	8607	8871	9311	9740	10180	10609	11049	MATERIAL: Maple
2	8378	8598	8807	9071	9511	9940	10380	10809	11249	MOIS. BARR: Included
3	8578	8798	9007	9271	9711	10140	10580	11009	11449	
4	8778	8998	9207	9471	9911	10340	10780	11209	11649	

Specify material and finish when ordering. Ganging is available. Power is available. See beginning of section for details on standard and optional items and pricing.

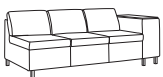

64143HC COMPOSE SOFA WITH 1 TABLE ARM

W: 80.5" D: 31" H: 31" SW: 69" SD: 21" SH: 18" AH: 26" WT: 129 lb COM: 9.5 yd WT CAP: 700 lb

ZONE	B/COM	C	D	E	F	G	H	I	J	GENERAL INFORMATION
1	6290	6480	6661	6889	7269	7639	8019	8390	8770	MATERIAL: Maple
2	6443	6633	6814	7042	7422	7792	8172	8543	8923	MOIS. BARR: Included
3	6597	6787	6968	7196	7576	7946	8326	8697	9077	
4	6750	6940	7121	7349	7729	8099	8479	8850	9230	

When ordering, specify table arm location (right or left) as facing the unit. Please use code LT (left table) or RT (right table). Specify material and finish when ordering. Ganging is available. Power is available. See beginning of section for details on standard and optional items and pricing.

Specify:

- Product Number
- Arm Location
- Fabric Vendor, Pattern and Color
- Thermoform Finish
- Laminate Finish
- Leg Option
- Power Option and Color
- Wood Option Only:
 - Wood Finish

See pages 16 & 17 for material and finish options.

Rally Compose with Embrace

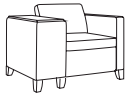

64241HC COMPOSE CHAIR WITH TABLE ARM AND EMBRACE ARM

W: 38" D: 31" H: 31" SW: 23" SD: 21" SH: 18" AH: 26" WT: 89 lb COM: 6.25 yd WT CAP: 400 lb

ZONE	B/COM	C	D	E	F	G	H	I	J	GENERAL INFORMATION
1	4933	5058	5177	5327	5577	5821	6071	6314	6564	MATERIAL: Maple
2	5054	5179	5298	5448	5698	5942	6192	6435	6685	MOIS. BARR: Included
3	5175	5300	5419	5569	5819	6063	6313	6556	6806	
4	5295	5420	5539	5689	5939	6183	6433	6676	6926	

When ordering, specify arm and table location (right or left) as facing the unit. Please use code LART (left arm, right table) or LTRA (left table, right arm). Specify material and finish when ordering. Power is available. See beginning of section for details on standard and optional items and pricing.

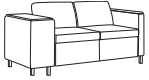

64242HC COMPOSE LOVESEAT WITH TABLE ARM AND EMBRACE ARM

W: 61" D: 31" H: 31" SW: 46" SD: 21" SH: 18" AH: 26" WT: 108 lb COM: 8.5 yd WT CAP: 600 lb

ZONE	B/COM	C	D	E	F	G	H	I	J	GENERAL INFORMATION
1	6049	6219	6381	6585	6925	7256	7596	7928	8268	MATERIAL: Maple
2	6197	6367	6529	6733	7073	7404	7744	8076	8416	MOIS. BARR: Included
3	6345	6515	6677	6881	7221	7552	7892	8224	8564	
4	6492	6662	6824	7028	7368	7699	8039	8371	8711	

When ordering, specify arm and table arm location (right or left) as facing the unit. Please use code LTRA (left table, right arm) or LART (left arm, right table). Specify material and finish when ordering. Ganging is available. Power is available. See beginning of section for details on standard and optional items and pricing.



64243HC COMPOSE SOFA WITH TABLE ARM AND EMBRACE ARM

W: 84" D: 31" H: 31" SW: 69" SD: 21" SH: 18" AH: 26" WT: 143 lb COM: 10.75 yd WT CAP: 700 lb

ZONE	B/COM	C	D	E	F	G	H	I	J	GENERAL INFORMATION
1	7047	7262	7466	7724	8154	8574	9004	9423	9853	MATERIAL: Maple
2	7219	7434	7638	7896	8326	8746	9176	9595	10025	MOIS. BARR: Included
3	7391	7606	7810	8068	8498	8918	9348	9767	10197	
4	7563	7778	7982	8240	8670	9090	9520	9939	10369	

When ordering, specify arm and table arm location (right or left) as facing the unit. Please use code LTRA (left table, right arm) or LART (left arm, right table). Specify material and finish when ordering. Ganging is available. Power is available. See beginning of section for details on standard and optional items and pricing.

Specify:

- Product Number
- Arm Location
- Fabric Vendor, Pattern and Color
- Thermoform Finish
- Laminate Finish
- Leg Option
- Power Option and Color

Wood Option Only:

- Wood Finish

See pages 16 & 17 for material and finish options.

Rally Armless Universal



64401HC ARMLESS CHAIR

		W: 23"	D: 31"	H: 31"	SW: 23"	SD: 21"	SH: 18"	AH: -	WT: 38 lb	COM: 3.5 yd	WT CAP: 400 lb
ZONE		B/COM	C	D	E	F	G	H	I	J	GENERAL INFORMATION
1		2237	2307	2374	2458	2598	2734	2874	3011	3151	MATERIAL: Maple
2		2292	2362	2429	2513	2653	2789	2929	3066	3206	MOIS. BARR: Included
3		2346	2416	2483	2567	2707	2843	2983	3120	3260	
4		2401	2471	2538	2622	2762	2898	3038	3175	3315	

Ganging is available. See beginning of section for details on standard and optional items and pricing.



64402HC ARMLESS LOVESEAT

		W: 46"	D: 31"	H: 31"	SW: 46"	SD: 21"	SH: 18"	AH: -	WT: 68 lb	COM: 5.5 yd	WT CAP: 600 lb
ZONE		B/COM	C	D	E	F	G	H	I	J	GENERAL INFORMATION
1		3491	3606	3715	3853	4083	4308	4538	4762	4992	MATERIAL: Maple
2		3576	3691	3800	3938	4168	4393	4623	4847	5077	MOIS. BARR: Included
3		3661	3776	3885	4023	4253	4478	4708	4932	5162	
4		3746	3861	3970	4108	4338	4563	4793	5017	5247	

Ganging is available. See beginning of section for details on standard and optional items and pricing.



64403HC ARMLESS SOFA

		W: 69"	D: 31"	H: 31"	SW: 69"	SD: 21"	SH: 18"	AH: -	WT: 103 lb	COM: 8 yd	WT CAP: 700 lb
ZONE		B/COM	C	D	E	F	G	H	I	J	GENERAL INFORMATION
1		4509	4669	4821	5013	5333	5645	5965	6277	6597	MATERIAL: Maple
2		4619	4779	4931	5123	5443	5755	6075	6387	6707	MOIS. BARR: Included
3		4728	4888	5040	5232	5552	5864	6184	6496	6816	
4		4838	4998	5150	5342	5662	5974	6294	6606	6926	

Ganging is available. See beginning of section for details on standard and optional items and pricing.

64441HC CORNER CHAIR

		W: 31"	D: 31"	H: 31"	SW: 21"	SD: 21"	SH: 18"	AH: -	WT: 65 lb	COM: 4.75 yd	WT CAP: 400 lb
ZONE		B/COM	C	D	E	F	G	H	I	J	GENERAL INFORMATION
1		3378	3473	3563	3677	3867	4053	4243	4428	4618	MATERIAL: Maple
2		3461	3556	3646	3760	3950	4136	4326	4511	4701	MOIS. BARR: Included
3		3543	3638	3728	3842	4032	4218	4408	4593	4783	
4		3626	3721	3811	3925	4115	4301	4491	4676	4866	

Ganging is available. See beginning of section for details on standard and optional items and pricing. Use of patterned fabric on seat is not recommended.



64454HC INSIDE WEDGE CHAIR, 30-DEGREE ANGLE WITH WIDE BACK

		W: 18-34"	D: 30"	H: 31"	SW: -	SD: -	SH: 18"	AH: -	WT: 44 lb	COM: 4.25 yd	WT CAP: 400 lb
ZONE		B/COM	C	D	E	F	G	H	I	J	GENERAL INFORMATION
1		2792	2877	2958	3060	3230	3396	3566	3731	3901	MATERIAL: Maple
2		2860	2945	3026	3128	3298	3464	3634	3799	3969	MOIS. BARR: Included
3		2928	3013	3094	3196	3366	3532	3702	3867	4037	
4		2996	3081	3162	3264	3434	3600	3770	3935	4105	

Ganging is available. See beginning of section for details on standard and optional items and pricing. Use of patterned fabric on seat is not recommended.



64455HC OUTSIDE WEDGE CHAIR, 30-DEGREE ANGLE WITH NARROW BACK

		W: 18-34"	D: 30"	H: 31"	SW: -	SD: -	SH: 18"	AH: -	WT: 40 lb	COM: 3.75 yd	WT CAP: 400 lb
ZONE		B/COM	C	D	E	F	G	H	I	J	GENERAL INFORMATION
1		2550	2625	2696	2786	2936	3083	3233	3379	3529	MATERIAL: Maple
2		2612	2687	2758	2848	2998	3145	3295	3441	3591	MOIS. BARR: Included
3		2674	2749	2820	2910	3060	3207	3357	3503	3653	
4		2737	2812	2883	2973	3123	3270	3420	3566	3716	

Ganging is available. See beginning of section for details on standard and optional items and pricing. Use of patterned fabric on seat is not recommended.

Specify:

- Product Number
- Fabric Vendor, Pattern and Color
- Leg Option
- Wood Option Only:
- Wood Finish

See pages 16 & 17 for material and finish options.

Rally Ottomans and Tables



64500 INTEGRATED TABLE

W: 22.5" D: 28.5" H: 26.75" SW: - SD: - SH: - AH: - WT: 63 lb COM: 1.75 yd WT CAP: -

ZONE	B/COM	C	D	E	F	G	H	I	J	GENERAL INFORMATION
1	3088	3123	3156	3198	3268	3337	3407	3475	3545	MATERIAL: Maple
2	3164	3199	3232	3274	3344	3413	3483	3551	3621	MOIS. BARR: Included
3	3241	3276	3309	3351	3421	3490	3560	3628	3698	
4	3318	3353	3386	3428	3498	3567	3637	3705	3775	

Table must be permanently attached to 2 units (armless on connection side). Must send in a layout with the order. Specify black or silver table leg when ordering. Casters are not available. Specify material and finish when ordering. Power is available. See beginning of section for details on standard and optional items and pricing.



64-OT OTTOMAN

W: 31" D: 31" H: 18" SW: - SD: - SH: - AH: - WT: 47 lb COM: 3 yd WT CAP: -

ZONE	B/COM	C	D	E	F	G	H	I	J	GENERAL INFORMATION
1	1580	1640	1697	1769	1889	2006	2126	2243	2363	MATERIAL: Maple
2	1618	1678	1735	1807	1927	2044	2164	2281	2401	MOIS. BARR: Included
3	1657	1717	1774	1846	1966	2083	2203	2320	2440	
4	1695	1755	1812	1884	2004	2121	2241	2358	2478	

Ottoman with low table top is available at an additional charge. Specify material and finish when ordering. Ganging is available. See beginning of section for details on standard and optional items and pricing.



64-CT-OT COFFEE TABLE OTTOMAN

W: 31" D: 31" H: 21" SW: - SD: - SH: - AH: - WT: 75 lb COM: 2 yd WT CAP: -

ZONE	B/COM	C	D	E	F	G	H	I	J	GENERAL INFORMATION
1	3831	3871	3909	3957	4037	4115	4195	4273	4353	MATERIAL: Maple
2	3926	3966	4004	4052	4132	4210	4290	4368	4448	MOIS. BARR: Included
3	4021	4061	4099	4147	4227	4305	4385	4463	4543	
4	4116	4156	4194	4242	4322	4400	4480	4558	4638	

Specify material and finish when ordering. Ganging is available. See beginning of section for details on standard and optional items and pricing. Not available with power option.



64-WG-OT WEDGE OTTOMAN, 30-DEGREE ANGLE

W: 18-34" D: 30" H: 18" SW: - SD: - SH: - AH: - WT: 35 lb COM: 3.5 yd WT CAP: -

ZONE	B/COM	C	D	E	F	G	H	I	J	GENERAL INFORMATION
1	1681	1741	1798	1870	1990	2107	2227	2344	2464	MATERIAL: Maple
2	1722	1782	1839	1911	2031	2148	2268	2385	2505	MOIS. BARR: Included
3	1763	1823	1880	1952	2072	2189	2309	2426	2546	
4	1803	1863	1920	1992	2112	2229	2349	2466	2586	

Low table top option available; specify material and finish when ordering. Power options available. Height is 15" with table top. Specify material and finish when ordering. Ganging is available on sides only. See beginning of section for details on standard and optional items and pricing.



64550 WEDGE TABLE, 30-DEGREE ANGLE

W: 18-34" D: 30" H: 26" SW: - SD: - SH: - AH: - WT: 67 lb COM: 2.75 yd WT CAP: -

ZONE	B/COM	C	D	E	F	G	H	I	J	GENERAL INFORMATION
1	2302	2357	2409	2475	2585	2693	2803	2910	3020	MATERIAL: Maple
2	2358	2413	2465	2531	2641	2749	2859	2966	3076	MOIS. BARR: Included
3	2415	2470	2522	2588	2698	2806	2916	3023	3133	
4	2471	2526	2578	2644	2754	2862	2972	3079	3189	

Specify material and finish when ordering. Ganging is available on sides only. See beginning of section for details on standard and optional items and pricing.

Specify:

- Product Number
- Fabric Vendor, Pattern and Color
- Thermoform Finish
- Laminate Finish
- Leg Option
- Power Option and Color

Wood Option Only:

- Wood Finish

See pages 16 & 17 for material and finish options.

Rally Ottomans and Tables



6422-OT 22" ROUND OTTOMAN

W: 22" D: 22" H: 18" SW: - SD: - SH: - AH: - WT: 26 lb COM: 1.5 yd WT CAP: -

ZONE	B/COM	C	D	E	F	G	H	I	J	GENERAL INFORMATION
1	12004	2034	2063	2099	2159	2217	2277	2336	2396	MATERIAL: Maple MOIS. BARR: Included
2	2054	2084	2113	2149	2209	2267	2327	2386	2446	
3	2103	2133	2162	2198	2258	2316	2376	2435	2495	
4	2152	2182	2211	2247	2307	2365	2425	2484	2544	

Low table top option available; specify material and finish when ordering. Height is 15" with table top. Power and ganging options not available. See beginning of section for details on standard and optional items and pricing.



6430-OT 30" ROUND OTTOMAN

W: 30" D: 30" H: 18" SW: - SD: - SH: - AH: - WT: 34 lb COM: 2.75 yd WT CAP: -

ZONE	B/COM	C	D	E	F	G	H	I	J	GENERAL INFORMATION
1	2352	2407	2459	2525	2635	2743	2853	2960	3070	MATERIAL: Maple MOIS. BARR: Included
2	2410	2465	2517	2583	2693	2801	2911	3018	3128	
3	2467	2522	2574	2640	2750	2858	2968	3075	3185	
4	2525	2580	2632	2698	2808	2916	3026	3133	3243	

Low table top option available; specify material and finish when ordering. Height is 15" with table top. Power and ganging options not available. See beginning of section for details on standard and optional items and pricing.

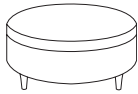

6436-OT 36" ROUND OTTOMAN

W: 36" D: 36" H: 18" SW: - SD: - SH: - AH: - WT: 44 lb COM: 3 yd WT CAP: -

ZONE	B/COM	C	D	E	F	G	H	I	J	GENERAL INFORMATION
1	2687	2747	2804	2876	2996	3113	3233	3350	3470	MATERIAL: Maple MOIS. BARR: Included
2	2753	2813	2870	2942	3062	3179	3299	3416	3536	
3	2819	2879	2936	3008	3128	3245	3365	3482	3602	
4	2885	2945	3002	3074	3194	3311	3431	3548	3668	

Low table top option available; specify material and finish when ordering. Height is 15" with table top. Power and ganging options not available. See beginning of section for details on standard and optional items and pricing.



6422-ET-OT 22" ROUND END TABLE

W: 22" D: 22" H: 22" SW: - SD: - SH: - AH: - WT: 34 lb COM: 1.5 yd WT CAP: -

ZONE	B/COM	C	D	E	F	G	H	I	J	GENERAL INFORMATION
1	2290	2320	2349	2385	2445	2503	2563	2622	2682	MATERIAL: Maple MOIS. BARR: Included
2	2347	2377	2406	2442	2502	2560	2620	2679	2739	
3	2403	2433	2462	2498	2558	2616	2676	2735	2795	
4	2460	2490	2519	2555	2615	2673	2733	2792	2852	

Specify material and finish when ordering. Power and ganging options not available. See beginning of section for details on standard and optional items and pricing.

Specify:

- Product Number
- Fabric Vendor, Pattern and Color
- Thermoform Finish
- Laminate Finish
- Leg Option
- Power Option and Color

Wood Option Only:

- Wood Finish

See pages 16 & 17 for material and finish options.

CLASSIC (FULL FRONT)



621 Series



621T Series

CUSTOM (SEAT CUSHION WITH BASE OPTIONS)



622 Series



622T Series

ARM CAP OPTIONS



Upholstered
(no upcharge)



Wood
(no upcharge)



Thermoform
(no upcharge)



Urethane
(no upcharge)

Specify black, sable or dove.



Solid Surface
\$311

Specify solid surface color.

LEG STYLES



Wood Leg
(standard)

There is no wood trim rail on custom models.



Metal Leg
\$470

Specify silver, black, bronze or gunmetal.



Plinth Base
\$470

Available on Classic models only.



Casters
\$508

For table models only specify wood or metal center feet. Casters are intended to aid housekeeping staff with moving when cleaning.

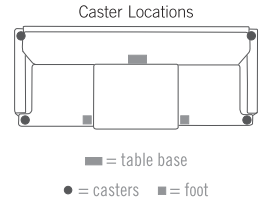

BASE OPTIONS - FOR CUSTOM STYLES ONLY



Ottoman
\$1009

Specify left or right and select wood or urethane handle (as facing).



Drawer - Fabric, Wood or Thermoform
\$404

Specify left, middle or right.

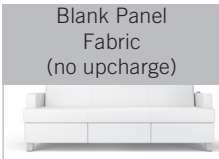

Blank Panel
Fabric
(no upcharge)

Specify left, middle or right.



Blank Panel
Wood or Thermoform
\$107

Specify left, middle or right.

POWER OPTIONS - FOR CLASSIC STYLE WITH TABLE AND CUSTOM STYLE WITH TABLE ONLY



7700001 USB/120V
Outlet \$759

OR



7700002 120V/120V
Outlet \$641



USB/120V Double
Outlet \$1518



120V/120V Double
Outlet \$1282

Available in black or silver. Usable cord length is 9'. Please get facility approval on power options before ordering. Specify right, left, or both. Power units are UL Listed Tamper Resistant outlets.

SLEEP SURFACE OPTIONS

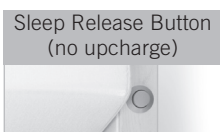

Sleep Release Button
(no upcharge)

Specify dark bronze, light grey or black. Specify right or left (right is default unless otherwise specified).

TABLE OPTIONS

Thermoform Table Top
(no upcharge)



Specify thermoform color.

Solid Surface Table Top



Specify solid surface color.

63"	\$648
66"	\$866
69"	\$1095
72"	\$1232
75"	\$1563
78"	\$1668

Wood Column Skirt
Cap (no upcharge)



Specify wood finish.

Thermoform Column
Skirt Cap (no upcharge)



Specify thermoform color.

Solid Surface Skirt Cap



Specify solid surface color.

63"	\$243
66"	\$319
69"	\$322
72"	\$322
75"	\$398
78"	\$398

Table Release Lever
(no upcharge)



Specify silver, black,
bronze or gunmetal.

OPTIONS LEGEND

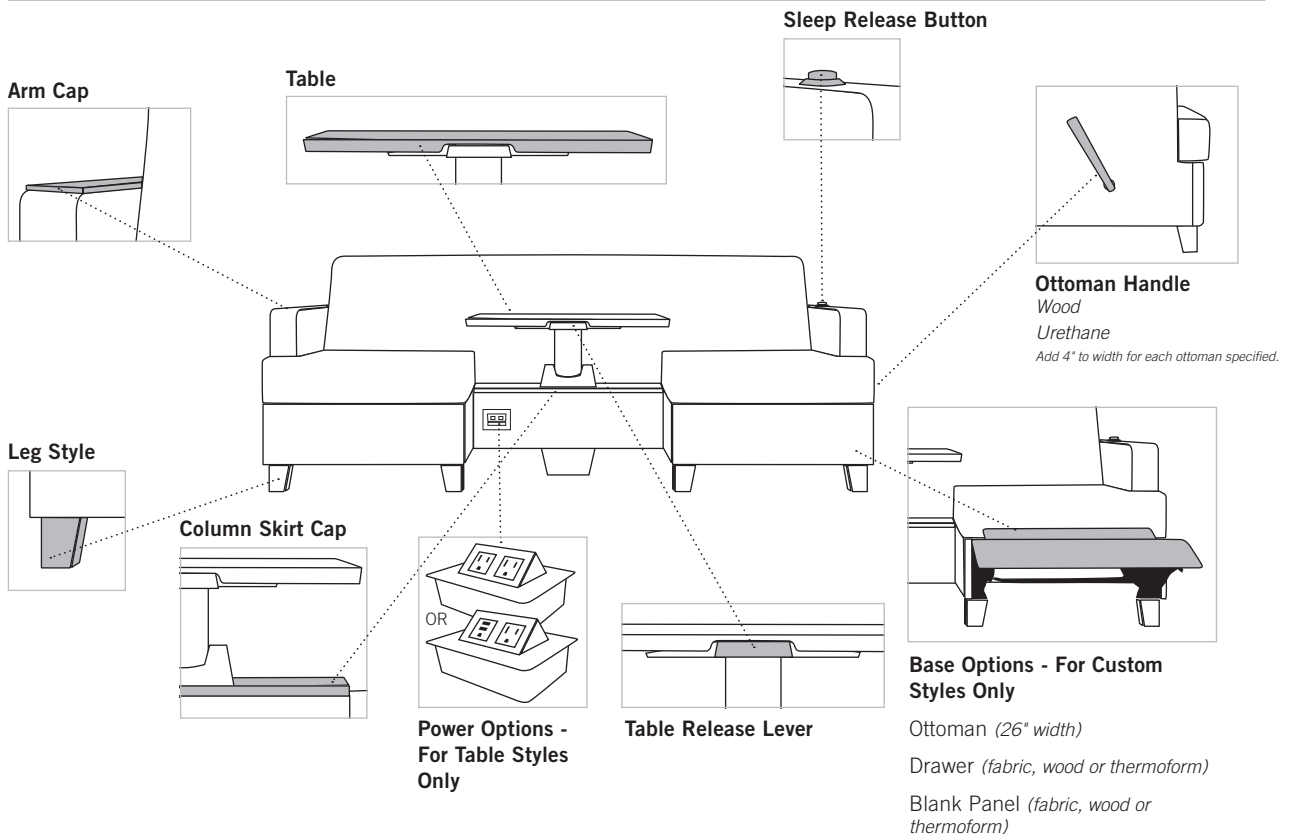

sleepToo® Classic

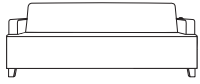

62166 SLEEP SOFA, CLASSIC FRONT, 66" SLEEP SURFACE

W: 74" D: 34" H: 33" SW: 66" SD: 21.5" SH: 18.5" AH: 24.5" WT: 172 lb COM: 8.25 yd WT CAP: 750 lb

ZONE	B/COM	C	D	E	F	G	H	I	J	GENERAL INFORMATION
1	8738	8903	9060	9258	9588	9910	10240	10561	10891	MATERIAL: Maple MOIS. BARR: Included
2	8953	9118	9275	9473	9803	10125	10455	10776	11106	
3	9168	9333	9490	9688	10018	10340	10670	10991	11321	
4	9383	9548	9705	9903	10233	10555	10885	11206	11536	

62169 SLEEP SOFA, CLASSIC FRONT, 69" SLEEP SURFACE

W: 77" D: 34" H: 33" SW: 69" SD: 21.5" SH: 18.5" AH: 24.5" WT: 178 lb COM: 8.25 yd WT CAP: 750 lb

ZONE	B/COM	C	D	E	F	G	H	I	J	GENERAL INFORMATION
1	8852	9017	9174	9372	9702	10024	10354	10675	11005	MATERIAL: Maple MOIS. BARR: Included
2	9070	9235	9392	9590	9920	10242	10572	10893	11223	
3	9288	9453	9610	9808	10138	10460	10790	11111	11441	
4	9506	9671	9828	10026	10356	10678	11008	11329	11659	

62172 SLEEP SOFA, CLASSIC FRONT, 72" SLEEP SURFACE

W: 80" D: 34" H: 33" SW: 72" SD: 21.5" SH: 18.5" AH: 24.5" WT: 184 lb COM: 8.25 yd WT CAP: 750 lb

ZONE	B/COM	C	D	E	F	G	H	I	J	GENERAL INFORMATION
1	8977	9142	9299	9497	9827	10149	10479	10800	11130	MATERIAL: Maple MOIS. BARR: Included
2	9198	9363	9520	9718	10048	10370	10700	11021	11351	
3	9419	9584	9741	9939	10269	10591	10921	11242	11572	
4	9640	9805	9962	10160	10490	10812	11142	11463	11793	

62175 SLEEP SOFA, CLASSIC FRONT, 75" SLEEP SURFACE

W: 83" D: 34" H: 33" SW: 75" SD: 21.5" SH: 18.5" AH: 24.5" WT: 190 lb COM: 8.25 yd WT CAP: 750 lb

ZONE	B/COM	C	D	E	F	G	H	I	J	GENERAL INFORMATION
1	9092	9257	9414	9612	9942	10264	10594	10915	11245	MATERIAL: Maple MOIS. BARR: Included
2	9316	9481	9638	9836	10166	10488	10818	11139	11469	
3	9540	9705	9862	10060	10390	10712	11042	11363	11693	
4	9764	9929	10086	10284	10614	10936	11266	11587	11917	

62178 SLEEP SOFA, CLASSIC FRONT, 78" SLEEP SURFACE

W: 86" D: 34" H: 33" SW: 78" SD: 21.5" SH: 18.5" AH: 24.5" WT: 196 lb COM: 8.25 yd WT CAP: 750 lb

ZONE	B/COM	C	D	E	F	G	H	I	J	GENERAL INFORMATION
1	9213	9378	9535	9733	10063	10385	10715	11036	11366	MATERIAL: Maple MOIS. BARR: Included
2	9440	9605	9762	9960	10290	10612	10942	11263	11593	
3	9667	9832	9989	10187	10517	10839	11169	11490	11820	
4	9894	10059	10216	10414	10744	11066	11396	11717	12047	

Specify:

- Product Number
- Wood Finish
- Urethane Color
- Fabric Vendor, Pattern and Color
- Thermoform Finish
- Metal Finish
- Arm Cap Style
- Leg Style
- Sleep Release Button (Left or Right, Color and Location)
- USB/Power Option

See pages 16 & 17 for material and finish options.

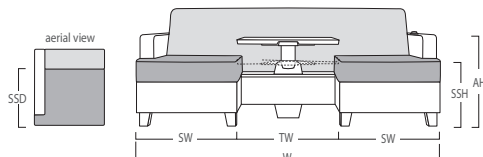

SSH- Sleep surface height 25"
 SSD- Sleep surface depth 30"
 SH- Seat height
 SW- Seat width
 W- Overall width
 Add 4" to overall width for each ottoman space.



sleepToo® Classic with Table

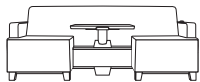

62163T SLEEP SOFA, CLASSIC FRONT, WITH TABLE, 63" SLEEP SURFACE

W: 71" D: 34" H: 33" SW: 22.5" SD: 21.5" SH: 18.5" AH: 24.5" WT: 211 lb COM: 7.75 yd WT CAP: 750 lb

ZONE	B/COM	C	D	E	F	G	H	I	J	GENERAL INFORMATION
1	11500	11655	11802	11988	12298	12601	12911	13213	13523	MATERIAL: Maple MOIS. BARR: Included
2	11784	11939	12086	12272	12582	12885	13195	13497	13807	
3	12069	12224	12371	12557	12867	13170	13480	13782	14092	
4	12353	12508	12655	12841	13151	13454	13764	14066	14376	

Power is not available on 63" model.

62166T SLEEP SOFA, CLASSIC FRONT, WITH TABLE, 66" SLEEP SURFACE

W: 74" D: 34" H: 33" SW: 22.5" SD: 21.5" SH: 18.5" AH: 24.5" WT: 216 lb COM: 7.75 yd WT CAP: 750 lb

ZONE	B/COM	C	D	E	F	G	H	I	J	GENERAL INFORMATION
1	11874	12029	12176	12362	12672	12975	13285	13587	13897	MATERIAL: Maple MOIS. BARR: Included
2	12168	12323	12470	12656	12966	13269	13579	13881	14191	
3	12462	12617	12764	12950	13260	13563	13873	14175	14485	
4	12755	12910	13057	13243	13553	13856	14166	14468	14778	

62169T SLEEP SOFA, CLASSIC FRONT, WITH TABLE, 69" SLEEP SURFACE

W: 77" D: 34" H: 33" SW: 22.5" SD: 21.5" SH: 18.5" AH: 24.5" WT: 221 lb COM: 7.75 yd WT CAP: 750 lb

ZONE	B/COM	C	D	E	F	G	H	I	J	GENERAL INFORMATION
1	11993	12148	12295	12481	12791	13094	13404	13706	14016	MATERIAL: Maple MOIS. BARR: Included
2	12290	12445	12592	12778	13088	13391	13701	14003	14313	
3	12586	12741	12888	13074	13384	13687	13997	14299	14609	
4	12883	13038	13185	13371	13681	13984	14294	14596	14906	

62172T SLEEP SOFA, CLASSIC FRONT, WITH TABLE, 72" SLEEP SURFACE

W: 80" D: 34" H: 33" SW: 22.5" SD: 21.5" SH: 18.5" AH: 24.5" WT: 226 lb COM: 7.75 yd WT CAP: 750 lb

ZONE	B/COM	C	D	E	F	G	H	I	J	GENERAL INFORMATION
1	12118	12273	12420	12606	12916	13219	13529	13831	14141	MATERIAL: Maple MOIS. BARR: Included
2	12418	12573	12720	12906	13216	13519	13829	14131	14441	
3	12718	12873	13020	13206	13516	13819	14129	14431	14741	
4	13018	13173	13320	13506	13816	14119	14429	14731	15041	

62175T SLEEP SOFA, CLASSIC FRONT, WITH TABLE, 75" SLEEP SURFACE

W: 83" D: 34" H: 33" SW: 22.5" SD: 21.5" SH: 18.5" AH: 24.5" WT: 231 lb COM: 7.75 yd WT CAP: 750 lb

ZONE	B/COM	C	D	E	F	G	H	I	J	GENERAL INFORMATION
1	12238	12393	12540	12726	13036	13339	13649	13951	14261	MATERIAL: Maple MOIS. BARR: Included
2	12541	12696	12843	13029	13339	13642	13952	14254	14564	
3	12844	12999	13146	13332	13642	13945	14255	14557	14867	
4	13147	13302	13449	13635	13945	14248	14558	14860	15170	

62178T SLEEP SOFA, CLASSIC FRONT, WITH TABLE, 78" SLEEP SURFACE

W: 86" D: 34" H: 33" SW: 22.5" SD: 21.5" SH: 18.5" AH: 24.5" WT: 236 lb COM: 7.75 yd WT CAP: 750 lb

ZONE	B/COM	C	D	E	F	G	H	I	J	GENERAL INFORMATION
1	12366	12521	12668	12854	13164	13467	13777	14079	14389	MATERIAL: Maple MOIS. BARR: Included
2	12672	12827	12974	13160	13470	13773	14083	14385	14695	
3	12978	13133	13280	13466	13776	14079	14389	14691	15001	
4	13284	13439	13586	13772	14082	14385	14695	14997	15307	

Specify:

- Product Number
- Wood Finish
- Urethane Color
- Fabric Vendor, Pattern and Color
- Thermoform Finish
- Metal Finish
- Arm Cap Style
- Leg Style
- Sleep Release Button (Left or Right, Color and Location)
- USB/Power Option

See pages 16 & 17 for material and finish options.

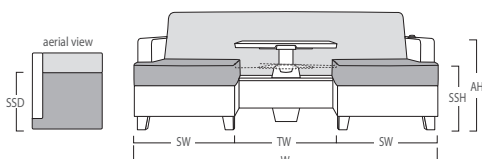

SSH- Sleep surface height 25"
 SSD- Sleep surface depth 30"
 SH- Seat height
 SW- Seat width
 W- Overall width
 Add 4" to overall width for each ottoman specified.

sleepToo® Custom

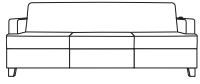

62266 SLEEP SOFA, CUSTOM FRONT, 66" SLEEP SURFACE

W: 74" D: 34" H: 33" SW: 66" SD: 21.5" SH: 18.5" AH: 24.5" WT: 174 lb COM: 9 yd WT CAP: 750 lb

ZONE	B/COM	C	D	E	F	G	H	I	J	GENERAL INFORMATION
1	8760	8940	9111	9327	9687	10038	10398	10749	11109	MATERIAL: Maple MOIS. BARR: Included
2	8975	9155	9326	9542	9902	10253	10613	10964	11324	
3	9191	9371	9542	9758	10118	10469	10829	11180	11540	
4	9406	9586	9757	9973	10333	10684	11044	11395	11755	

62269 SLEEP SOFA, CUSTOM FRONT, 69" SLEEP SURFACE

W: 77" D: 34" H: 33" SW: 69" SD: 21.5" SH: 18.5" AH: 24.5" WT: 180 lb COM: 9 yd WT CAP: 750 lb

ZONE	B/COM	C	D	E	F	G	H	I	J	GENERAL INFORMATION
1	8883	9063	9234	9450	9810	10161	10521	10872	11232	MATERIAL: Maple MOIS. BARR: Included
2	9101	9281	9452	9668	10028	10379	10739	11090	11450	
3	9320	9500	9671	9887	10247	10598	10958	11309	11669	
4	9538	9718	9889	10105	10465	10816	11176	11527	11887	

62272 SLEEP SOFA, CUSTOM FRONT, 72" SLEEP SURFACE

W: 80" D: 34" H: 33" SW: 72" SD: 21.5" SH: 18.5" AH: 24.5" WT: 186 lb COM: 9 yd WT CAP: 750 lb

ZONE	B/COM	C	D	E	F	G	H	I	J	GENERAL INFORMATION
1	9000	9180	9351	9567	9927	10278	10638	10989	11349	MATERIAL: Maple MOIS. BARR: Included
2	9221	9401	9572	9788	10148	10499	10859	11210	11570	
3	9443	9623	9794	10010	10370	10721	11081	11432	11792	
4	9664	9844	10015	10231	10591	10942	11302	11653	12013	

62275 SLEEP SOFA, CUSTOM FRONT, 75" SLEEP SURFACE

W: 83" D: 34" H: 33" SW: 75" SD: 21.5" SH: 18.5" AH: 24.5" WT: 192 lb COM: 9 yd WT CAP: 750 lb

ZONE	B/COM	C	D	E	F	G	H	I	J	GENERAL INFORMATION
1	9119	9299	9470	9686	10046	10397	10757	11108	11468	MATERIAL: Maple MOIS. BARR: Included
2	9343	9523	9694	9910	10270	10621	10981	11332	11692	
3	9568	9748	9919	10135	10495	10846	11206	11557	11917	
4	9792	9972	10143	10359	10719	11070	11430	11781	12141	

62278 SLEEP SOFA, CUSTOM FRONT, 78" SLEEP SURFACE

W: 86" D: 34" H: 33" SW: 78" SD: 21.5" SH: 18.5" AH: 24.5" WT: 198 lb COM: 9 yd WT CAP: 750 lb

ZONE	B/COM	C	D	E	F	G	H	I	J	GENERAL INFORMATION
1	9237	9417	9588	9804	10164	10515	10875	11226	11586	MATERIAL: Maple MOIS. BARR: Included
2	9464	9644	9815	10031	10391	10742	11102	11453	11813	
3	9692	9872	10043	10259	10619	10970	11330	11681	12041	
4	9919	10099	10270	10486	10846	11197	11557	11908	12268	

Specify:

- Product Number
- Wood Finish
- Urethane Color
- Fabric Vendor, Pattern and Color
- Thermoform Finish
- Metal Finish
- Arm Cap Style
- Leg Style
- Sleep Release Button (Left or Right, Color and Location)
- USB/Power Option

See pages 16 & 17 for material and finish options.

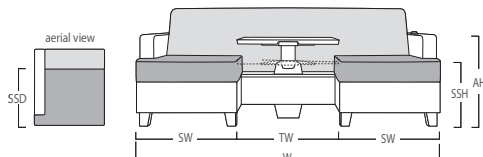

SSH- Sleep surface height 25"
 SSD- Sleep surface depth 30"
 SH- Seat height
 SW- Seat width
 W- Overall width
 Add 4" to overall width for each ottoman specified.

sleepToo® Custom with Table

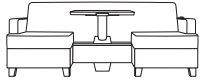

62263T SLEEP SOFA, CUSTOM FRONT, WITH TABLE, 63" SLEEP SURFACE

W: 71" D: 34" H: 33" SW: 22.5" SD: 21.5" SH: 18.5" AH: 24.5" WT: 215 lb COM: 8.5 yd WT CAP: 750 lb

ZONE	B/COM	C	D	E	F	G	H	I	J	GENERAL INFORMATION
1	11512	11682	11844	12048	12388	12719	13059	13391	13731	MATERIAL: Maple MOIS. BARR: Included
2	11796	11966	12128	12332	12672	13003	13343	13675	14015	
3	12081	12251	12413	12617	12957	13288	13628	13960	14300	
4	12365	12535	12697	12901	13241	13572	13912	14244	14584	

Power is not available on 63" model.

62266T SLEEP SOFA, CUSTOM FRONT, WITH TABLE, 66" SLEEP SURFACE

W: 74" D: 34" H: 33" SW: 22.5" SD: 21.5" SH: 18.5" AH: 24.5" WT: 220 lb COM: 8.5 yd WT CAP: 750 lb

ZONE	B/COM	C	D	E	F	G	H	I	J	GENERAL INFORMATION
1	11890	12060	12222	12426	12766	13097	13437	13769	14109	MATERIAL: Maple MOIS. BARR: Included
2	12184	12354	12516	12720	13060	13391	13731	14063	14403	
3	12478	12648	12810	13014	13354	13685	14025	14357	14697	
4	12772	12942	13104	13308	13648	13979	14319	14651	14991	

62269T SLEEP SOFA, CUSTOM FRONT, WITH TABLE, 69" SLEEP SURFACE

W: 77" D: 34" H: 33" SW: 22.5" SD: 21.5" SH: 18.5" AH: 24.5" WT: 225 lb COM: 8.5 yd WT CAP: 750 lb

ZONE	B/COM	C	D	E	F	G	H	I	J	GENERAL INFORMATION
1	12017	12187	12349	12553	12893	13224	13564	13896	14236	MATERIAL: Maple MOIS. BARR: Included
2	12314	12484	12646	12850	13190	13521	13861	14193	14533	
3	12611	12781	12943	13147	13487	13818	14158	14490	14830	
4	12908	13078	13240	13444	13784	14115	14455	14787	15127	

62272T SLEEP SOFA, CUSTOM FRONT, WITH TABLE, 72" SLEEP SURFACE

W: 80" D: 34" H: 33" SW: 22.5" SD: 21.5" SH: 18.5" AH: 24.5" WT: 230 lb COM: 8.5 yd WT CAP: 750 lb

ZONE	B/COM	C	D	E	F	G	H	I	J	GENERAL INFORMATION
1	12136	12306	12468	12672	13012	13343	13683	14015	14355	MATERIAL: Maple MOIS. BARR: Included
2	12436	12606	12768	12972	13312	13643	13983	14315	14655	
3	12736	12906	13068	13272	13612	13943	14283	14615	14955	
4	13036	13206	13368	13572	13912	14243	14583	14915	15255	

62275T SLEEP SOFA, CUSTOM FRONT, WITH TABLE, 75" SLEEP SURFACE

W: 83" D: 34" H: 33" SW: 22.5" SD: 21.5" SH: 18.5" AH: 24.5" WT: 235 lb COM: 8.5 yd WT CAP: 750 lb

ZONE	B/COM	C	D	E	F	G	H	I	J	GENERAL INFORMATION
1	12260	12430	12592	12796	13136	13467	13807	14139	14479	MATERIAL: Maple MOIS. BARR: Included
2	12563	12733	12895	13099	13439	13770	14110	14442	14782	
3	12866	13036	13198	13402	13742	14073	14413	14745	15085	
4	13169	13339	13501	13705	14045	14376	14716	15048	15388	

62278T SLEEP SOFA, CUSTOM FRONT, WITH TABLE, 78" SLEEP SURFACE

W: 86" D: 34" H: 33" SW: 22.5" SD: 21.5" SH: 18.5" AH: 24.5" WT: 240 lb COM: 8.5 yd WT CAP: 750 lb

ZONE	B/COM	C	D	E	F	G	H	I	J	GENERAL INFORMATION
1	12385	12555	12717	12921	13261	13592	13932	14264	14604	MATERIAL: Maple MOIS. BARR: Included
2	12691	12861	13023	13227	13567	13898	14238	14570	14910	
3	12997	13167	13329	13533	13873	14204	14544	14876	15216	
4	13304	13474	13636	13840	14180	14511	14851	15183	15523	

Specify:

- Product Number
- Wood Finish
- Urethane Color
- Fabric Vendor, Pattern and Color
- Thermoform Finish
- Metal Finish
- Arm Cap Style
- Leg Style
- Sleep Release Button (Left or Right, Color and Location)
- USB/Power Option

See pages 16 & 17 for material and finish options.

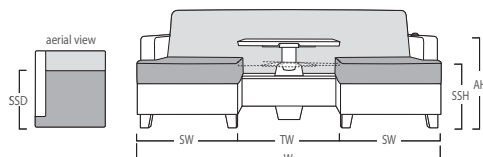

SSH- Sleep surface height 25"
SSD- Sleep surface depth 30"
SH- Seat height
SW- Seat width
W- Overall width
Add 4" to overall width for each ottoman specified.

Soul Sleep Sofa + Mate

ARM STYLES

Upholstered Arm Cap
(no upcharge)



Select from Momentum Silica Cumulus or Lotus; Momentum Silica Etch Almond, Flint, Nickel, Wetstone or Wistful; Momentum Silica Leather Almond, Dove, Pewter, Shadow or Eclipse.

Solid Surface Arm Cap \$1029



Select from Glacier White, Cameo White or Bisque only.

ACCESSORIES

1700001 USB/USBc Outlet \$525 each



Available in black or silver. Usable cord length is 9'. Please get facility approval on power options before ordering. Specify right, left, or both. Power units are UL Listed Tamper Resistant outlets.

Backstop \$263



Available in silver only. If ordering Soul Mate, specify this option to prevent the mate from hitting the wall when stowed.

FINISH OPTIONS

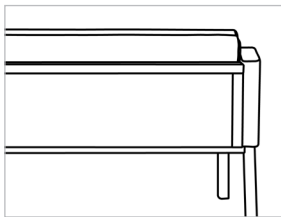

Back Panel

Wilsonart Silver Oak Ply
8203k-28 only

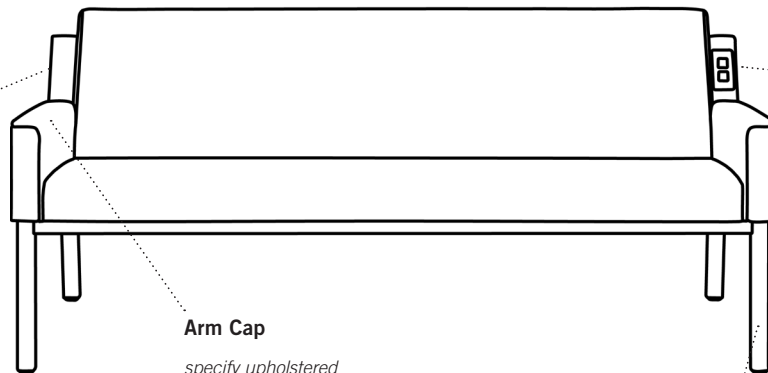

Arm Cap

specify upholstered or solid surface

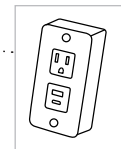

Power

specify black or silver

Frame/Legs

silver only

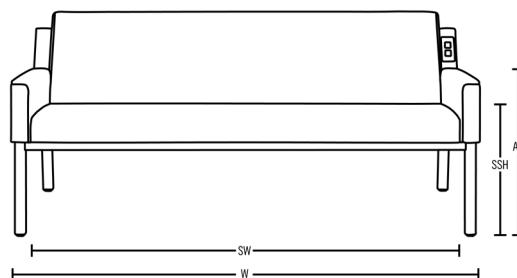
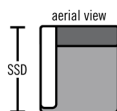
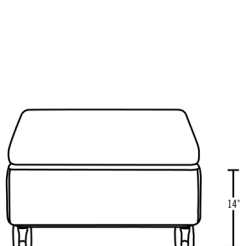

SSH- Sleep surface height 24"
SSD- Sleep surface depth 30"
SH- Seat height
SW- Seat width
W- Overall width
Mate is 14" from ground when closed (ottoman position).

Soul Sleep Sofa + Mate



17024 SOUL MATE, CONVERTIBLE CUBE, 24" SEAT

W: 24.5" D: 24.5" H: 38.5" SW: 24.25" SD: 19.5" SH: 17.25" AH: – WT: 67 lb COM: 2.5 yd WT CAP: 400 lb

ZONE	B/COM	C	D	E	F	G	H	I	J	GENERAL INFORMATION
1	3888	3938	3986	4046	4146	4243	4343	4441	4541	MATERIAL: Various MOIS. BARR: Included
2	3984	4034	4082	4142	4242	4339	4439	4537	4637	
3	4080	4130	4178	4238	4338	4435	4535	4633	4733	
4	4177	4227	4275	4335	4435	4532	4632	4730	4830	



17166 SLEEP SOFA, 66" SLEEP SURFACE, 72" WIDE

W: 72" D: 32" H: 34" SW: 66" SD: 20" SH: 19.5" AH: 25.5" WT: 200 lb COM: 5 yd WT CAP: 750 lb

ZONE	B/COM	C	D	E	F	G	H	I	J	GENERAL INFORMATION
1	9024	9124	9219	9339	9539	9734	9934	10129	10329	MATERIAL: Various MOIS. BARR: Included
2	9248	9348	9443	9563	9763	9958	10158	10353	10553	
3	9471	9571	9666	9786	9986	10181	10381	10576	10776	
4	9695	9795	9890	10010	10210	10405	10605	10800	11000	

17169 SLEEP SOFA, 69" SLEEP SURFACE, 75" WIDE

W: 75" D: 32" H: 34" SW: 69" SD: 20" SH: 19.5" AH: 25.5" WT: 205 lb COM: 5 yd WT CAP: 750 lb

ZONE	B/COM	C	D	E	F	G	H	I	J	GENERAL INFORMATION
1	9149	9249	9344	9464	9664	9859	10059	10254	10454	MATERIAL: Various MOIS. BARR: Included
2	9376	9476	9571	9691	9891	10086	10286	10481	10681	
3	9602	9702	9797	9917	10117	10312	10512	10707	10907	
4	9829	9929	10024	10144	10344	10539	10739	10934	11134	

17172 SLEEP SOFA, 72" SLEEP SURFACE, 78" WIDE

W: 78" D: 32" H: 34" SW: 72" SD: 20" SH: 19.5" AH: 25.5" WT: 210 lb COM: 5.25 yd WT CAP: 750 lb

ZONE	B/COM	C	D	E	F	G	H	I	J	GENERAL INFORMATION
1	9278	9383	9483	9609	9819	10024	10234	10438	10648	MATERIAL: Various MOIS. BARR: Included
2	9508	9613	9713	9839	10049	10254	10464	10668	10878	
3	9738	9843	9943	10069	10279	10484	10694	10898	11108	
4	9968	10073	10173	10299	10509	10714	10924	11128	11338	

17175 SLEEP SOFA, 75" SLEEP SURFACE, 81" WIDE

W: 81" D: 32" H: 34" SW: 75" SD: 20" SH: 19.5" AH: 25.5" WT: 215 lb COM: 5.25 yd WT CAP: 750 lb

ZONE	B/COM	C	D	E	F	G	H	I	J	GENERAL INFORMATION
1	9402	9507	9607	9733	9943	10148	10358	10562	10772	MATERIAL: Various MOIS. BARR: Included
2	9635	9740	9840	9966	10176	10381	10591	10795	11005	
3	9868	9973	10073	10199	10409	10614	10824	11028	11238	
4	10101	10206	10306	10432	10642	10847	11057	11261	11471	

17178 SLEEP SOFA, 78" SLEEP SURFACE, 84" WIDE

W: 84" D: 32" H: 34" SW: 78" SD: 20" SH: 19.5" AH: 25.5" WT: 220 lb COM: 6 yd WT CAP: 750 lb

ZONE	B/COM	C	D	E	F	G	H	I	J	GENERAL INFORMATION
1	9539	9659	9773	9917	10157	10391	10631	10865	11105	MATERIAL: Various MOIS. BARR: Included
2	9775	9895	10009	10153	10393	10627	10867	11101	11341	
3	10011	10131	10245	10389	10629	10863	11103	11337	11577	
4	10247	10367	10481	10625	10865	11099	11339	11573	11813	

Specify:

- Product Number
- Fabric, Vendor, Pattern and Color
- Arm Cap Style
- Solid Surface Color
- Power Option
- Backstop Option

See pages 16 & 17 for material and finish options.



804020 CHILDREN'S STOOL

GENERAL INFORMATION

W: 18" L: 18" H: 12" WT: 14 lb

MATERIAL: Metal
MOIS. BARR: -

Zone	1	2	3	4
	358	367	376	385

Laminate top with smooth metal base. Specify laminate and metal colors when ordering - see Finish by Product chart in Ordering Information section for available selections.



803030SQ CHILDREN'S TABLE, SQUARE, 30 X 30 INCH

GENERAL INFORMATION

W: 30" L: 30" H: 21" WT: 38 lb

MATERIAL: Metal
MOIS. BARR: -

Zone	1	2	3	4
	897	919	942	964

Laminate top with smooth metal base. Specify laminate and metal colors when ordering - see Finish by Product chart in Ordering Information section for available selections.



803232BN CHILDREN'S TABLE, KIDNEY

GENERAL INFORMATION

W: 32" L: 32" H: 21" WT: 35 lb

MATERIAL: Metal
MOIS. BARR: -

Zone	1	2	3	4
	897	919	942	964

Laminate top with smooth metal base. Specify laminate and metal colors when ordering - see Finish by Product chart in Ordering Information section for available selections.

Edge Style Options



FLAT PVC EDGE

Available in 7 colors to match metal finishes.

Specify:

- Product Number
- Metal Finish
- Edge Finish
- Laminate Vendor, Pattern and Finish

See pages 16 & 17 for material and finish options.

ARM CAP OPTIONS



Standard.



Specify black, sable or dove.



See ordering information for color options.



Specify solid surface color.

SEAT OPTIONS



Standard.



Call for COM yardage.

BACK OPTIONS



Standard.



Call for COM yardage.
Standard on Motion Chairs
at no upcharge.

ACCESSORIES

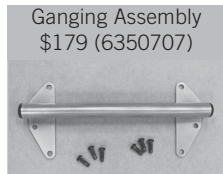

Adds 1.75" between chairs.
One required between each
seat.



Trace Metal Waiting and Motion



6351122 CHAIR, 22" SEAT, METAL FRAME

W: 26" D: 24.5" H: 32.75" SW: 22" SD: 18" SH: 18.5" AH: 25" WT: 33 lb COM: 1.75 yd WT CAP: 550 lb

ZONE	B/COM	C	D	E	F	G	H	I	J	GENERAL INFORMATION
1	2470	2505	2538	2580	2650	2719	2789	2857	2927	MATERIAL: Metal MOIS. BARR: \$21
2	2531	2566	2599	2641	2711	2780	2850	2918	2988	
3	2592	2627	2660	2702	2772	2841	2911	2979	3049	
4	2653	2688	2721	2763	2833	2902	2972	3040	3110	

COM yardage includes standard wood reveal seat and wood outer back only.



63511M22 MOTION CHAIR, 22" SEAT, METAL FRAME

W: 26" D: 24.5" H: 32.75" SW: 22" SD: 18" SH: 18.5" AH: 25" WT: 43 lb COM: 2 yd WT CAP: 550 lb

ZONE	B/COM	C	D	E	F	G	H	I	J	GENERAL INFORMATION
1	3252	3292	3330	3378	3458	3536	3616	3694	3774	MATERIAL: Metal MOIS. BARR: \$24
2	3332	3372	3410	3458	3538	3616	3696	3774	3854	
3	3413	3453	3491	3539	3619	3697	3777	3855	3935	
4	3494	3534	3572	3620	3700	3778	3858	3936	4016	

Only available with fully upholstered seat and outer back (no upcharge).

6351130 CHAIR, 30" SEAT, METAL FRAME

W: 34" D: 24.5" H: 32.75" SW: 30" SD: 18" SH: 18.5" AH: 25" WT: 40 lb COM: 2 yd WT CAP: 750 lb

ZONE	B/COM	C	D	E	F	G	H	I	J	GENERAL INFORMATION
1	2782	2822	2860	2908	2988	3066	3146	3224	3304	MATERIAL: Metal MOIS. BARR: \$24
2	2851	2891	2929	2977	3057	3135	3215	3293	3373	
3	2920	2960	2998	3046	3126	3204	3284	3362	3442	
4	2988	3028	3066	3114	3194	3272	3352	3430	3510	

COM yardage includes standard wood reveal seat and wood outer back only.

63511M30 MOTION CHAIR, 30" SEAT, METAL FRAME

W: 34" D: 24.5" H: 32.75" SW: 30" SD: 18" SH: 18.5" AH: 25" WT: 50 lb COM: 2.75 yd WT CAP: 750 lb

ZONE	B/COM	C	D	E	F	G	H	I	J	GENERAL INFORMATION
1	3556	3611	3663	3729	3839	3947	4057	4164	4274	MATERIAL: Metal MOIS. BARR: \$33
2	3644	3699	3751	3817	3927	4035	4145	4252	4362	
3	3732	3787	3839	3905	4015	4123	4233	4340	4450	
4	3819	3874	3926	3992	4102	4210	4320	4427	4537	

Only available with fully upholstered seat and outer back (no upcharge).

6351140 CHAIR, 40" SEAT, METAL FRAME

W: 44" D: 24.5" H: 32.75" SW: 40" SD: 18" SH: 18.5" AH: 25" WT: 50 lb COM: 2 yd WT CAP: 750 lb

ZONE	B/COM	C	D	E	F	G	H	I	J	GENERAL INFORMATION
1	3117	3157	3195	3243	3323	3401	3481	3559	3639	MATERIAL: Metal MOIS. BARR: \$24
2	3194	3234	3272	3320	3400	3478	3558	3636	3716	
3	3271	3311	3349	3397	3477	3555	3635	3713	3793	
4	3348	3388	3426	3474	3554	3632	3712	3790	3870	

COM yardage includes standard wood reveal seat and wood outer back only.

Specify:

- Product Number
- Wood Finish
- Back Style
- Seat Style
- Arm Cap Style
- Arm Cap Color
- Fabric Vendor,
Pattern and Color

See pages 16 & 17 for material and finish options.

Trace Wood Waiting



6341122 CHAIR, 22" SEAT, WOOD FRAME

W: 26" D: 24.5" H: 32.75" SW: 22" SD: 18" SH: 18.5" AH: 25" WT: 39 lb COM: 1.75 yd WT CAP: 550 lb

ZONE	B/COM	C	D	E	F	G	H	I	J	GENERAL INFORMATION
1	2470	2505	2538	2580	2650	2719	2789	2857	2927	MATERIAL: Beech MOIS. BARR: \$21
2	2531	2566	2599	2641	2711	2780	2850	2918	2988	
3	2592	2627	2660	2702	2772	2841	2911	2979	3049	
4	2653	2688	2721	2763	2833	2902	2972	3040	3110	

COM yardage includes standard wood reveal seat and wood outer back only.

6341130 CHAIR, 30" SEAT, WOOD FRAME

W: 34" D: 24.5" H: 32.75" SW: 30" SD: 18" SH: 18.5" AH: 25" WT: 53 lb COM: 2 yd WT CAP: 750 lb

ZONE	B/COM	C	D	E	F	G	H	I	J	GENERAL INFORMATION
1	2782	2822	2860	2908	2988	3066	3146	3224	3304	MATERIAL: Beech MOIS. BARR: \$24
2	2851	2891	2929	2977	3057	3135	3215	3293	3373	
3	2920	2960	2998	3046	3126	3204	3284	3362	3442	
4	2988	3028	3066	3114	3194	3272	3352	3430	3510	

COM yardage includes standard wood reveal seat and wood outer back only.

6341140 CHAIR, 40" SEAT, WOOD FRAME

W: 44" D: 24.5" H: 32.75" SW: 40" SD: 18" SH: 18.5" AH: 25" WT: 65 lb COM: 2 yd WT CAP: 750 lb

ZONE	B/COM	C	D	E	F	G	H	I	J	GENERAL INFORMATION
1	3117	3157	3195	3243	3323	3401	3481	3559	3639	MATERIAL: Beech MOIS. BARR: \$24
2	3194	3234	3272	3320	3400	3478	3558	3636	3716	
3	3271	3311	3349	3397	3477	3555	3635	3713	3793	
4	3348	3388	3426	3474	3554	3632	3712	3790	3870	

COM yardage includes standard wood reveal seat and wood outer back only.

Specify:

- Product Number
- Wood Finish
- Back Style
- Seat Style
- Arm Cap Style
- Arm Cap Color
- Fabric Vendor, Pattern and Color

See pages 16 & 17 for material and finish options.

Trace Metal Patient and Motion



6357122 PATIENT CHAIR, 22" SEAT, METAL FRAME, HIGH BACK

W: 26" D: 24.5" H: 43" SW: 22" SD: 18" SH: 18.5" AH: 25" WT: 37 lb COM: 1.75 yd WT CAP: 550 lb

ZONE	B/COM	C	D	E	F	G	H	I	J	GENERAL INFORMATION
1	2804	2839	2872	2914	2984	3053	3123	3191	3261	MATERIAL: Metal MOIS. BARR: \$21
2	2873	2908	2941	2983	3053	3122	3192	3260	3330	
3	2943	2978	3011	3053	3123	3192	3262	3330	3400	
4	3012	3047	3080	3122	3192	3261	3331	3399	3469	

COM yardage includes standard wood reveal seat and wood outer back only.

6357130 PATIENT CHAIR, 30" SEAT, METAL FRAME, HIGH BACK

W: 34" D: 24.5" H: 43" SW: 30" SD: 18" SH: 18.5" AH: 25" WT: 48 lb COM: 2.25 yd WT CAP: 750 lb

ZONE	B/COM	C	D	E	F	G	H	I	J	GENERAL INFORMATION
1	3496	3541	3584	3638	3728	3816	3906	3993	4083	MATERIAL: Metal MOIS. BARR: \$27
2	3582	3627	3670	3724	3814	3902	3992	4079	4169	
3	3669	3714	3757	3811	3901	3989	4079	4166	4256	
4	3756	3801	3844	3898	3988	4076	4166	4253	4343	

COM yardage includes standard wood reveal seat and wood outer back only.



6350100 OTTOMAN, 13" HEIGHT, METAL FRAME

W: 18.5" D: 17" H: 13" SW: - SD: - SH: - AH: - WT: 10 lb COM: 1.5 yd WT CAP: 300 lb

ZONE	B/COM	C	D	E	F	G	H	I	J	GENERAL INFORMATION
1	1242	1272	1301	1337	1397	1455	1515	1574	1634	MATERIAL: Metal MOIS. BARR: \$18
2	1272	1302	1331	1367	1427	1485	1545	1604	1664	
3	1303	1333	1362	1398	1458	1516	1576	1635	1695	
4	1333	1363	1392	1428	1488	1546	1606	1665	1725	

COM yardage includes standard wood reveal seat and wood outer back only.



63571M22 MOTION PATIENT CHAIR, 22" SEAT, METAL FRAME

W: 26" D: 24.5" H: 43" SW: 22" SD: 18" SH: 18.5" AH: 25" WT: 47 lb COM: 2.25 yd WT CAP: 550 lb

ZONE	B/COM	C	D	E	F	G	H	I	J	GENERAL INFORMATION
1	3576	3621	3664	3718	3808	3896	3986	4073	4163	MATERIAL: Metal MOIS. BARR: \$27
2	3664	3709	3752	3806	3896	3984	4074	4161	4251	
3	3753	3798	3841	3895	3985	4073	4163	4250	4340	
4	3842	3887	3930	3984	4074	4162	4252	4339	4429	

Only available with fully upholstered seat and outer back (no upcharge).

63571M30 MOTION PATIENT CHAIR, 30" SEAT, METAL FRAME

W: 34" D: 24.5" H: 43" SW: 30" SD: 18" SH: 18.5" AH: 25" WT: 58 lb COM: 3.25 yd WT CAP: 750 lb

ZONE	B/COM	C	D	E	F	G	H	I	J	GENERAL INFORMATION
1	4237	4302	4364	4442	4572	4699	4829	4955	5085	MATERIAL: Metal MOIS. BARR: \$39
2	4342	4407	4469	4547	4677	4804	4934	5060	5190	
3	4446	4511	4573	4651	4781	4908	5038	5164	5294	
4	4551	4616	4678	4756	4886	5013	5143	5269	5399	

Only available with fully upholstered seat and outer back (no upcharge).



6350100M OTTOMAN, 11" HEIGHT, METAL FRAME, MOTION

W: 18.5" D: 17" H: 11" SW: - SD: - SH: - AH: - WT: 10.5 lb COM: 1.5 yd WT CAP: 300 lb

ZONE	B/COM	C	D	E	F	G	H	I	J	GENERAL INFORMATION
1	1242	1272	1301	1337	1397	1455	1515	1574	1634	MATERIAL: Metal MOIS. BARR: \$18
2	1272	1302	1331	1367	1427	1485	1545	1604	1664	
3	1303	1333	1362	1398	1458	1516	1576	1635	1695	
4	1333	1363	1392	1428	1488	1546	1606	1665	1725	

Designed to nest under motion chairs. Comes standard as fully upholstered.

Specify:

- Product Number
- Wood Finish
- Back Style
- Seat Style
- Arm Cap Style
- Arm Cap Color
- Fabric Vendor, Pattern and Color

See pages 16 & 17 for material and finish options.

Trace Wood Patient



6347122 PATIENT CHAIR, 22" SEAT, WOOD FRAME, HIGH BACK

W: 26"	D: 24.25"	H: 43"	SW: 22"	SD: 18"	SH: 18.5"	AH: 25"	WT: 46 lb	COM: 1.75 yd	WT CAP: 550 lb	
ZONE	B/COM	C	D	E	F	G	H	I	J	GENERAL INFORMATION
1	2804	2839	2872	2914	2984	3053	3123	3191	3261	MATERIAL: Beech MOIS. BARR: \$21
2	2873	2908	2941	2983	3053	3122	3192	3260	3330	
3	2943	2978	3011	3053	3123	3192	3262	3330	3400	
4	3012	3047	3080	3122	3192	3261	3331	3399	3469	

COM yardage includes standard wood reveal seat and wood outer back only.

6347130 PATIENT CHAIR, 30" SEAT, WOOD FRAME, HIGH BACK

W: 34"	D: 24.25"	H: 43"	SW: 30"	SD: 18"	SH: 18.5"	AH: 25"	WT: 58 lb	COM: 2.25 yd	WT CAP: 750 lb	
ZONE	B/COM	C	D	E	F	G	H	I	J	GENERAL INFORMATION
1	3496	3541	3584	3638	3728	3816	3906	3993	4083	MATERIAL: Beech MOIS. BARR: \$27
2	3582	3627	3670	3724	3814	3902	3992	4079	4169	
3	3669	3714	3757	3811	3901	3989	4079	4166	4256	
4	3756	3801	3844	3898	3988	4076	4166	4253	4343	

COM yardage includes standard wood reveal seat and wood outer back only.



6340100 OTTOMAN, WOOD FRAME, 13" HEIGHT

W: 18.5"	D: 17"	H: 13"	SW: -	SD: -	SH: -	AH: -	WT: 18 lb	COM: 1.5 yd	WT CAP: 300 lb	
ZONE	B/COM	C	D	E	F	G	H	I	J	GENERAL INFORMATION
1	1242	1272	1301	1337	1397	1455	1515	1574	1634	MATERIAL: Beech MOIS. BARR: \$18
2	1272	1302	1331	1367	1427	1485	1545	1604	1664	
3	1303	1333	1362	1398	1458	1516	1576	1635	1695	
4	1333	1363	1392	1428	1488	1546	1606	1665	1725	

COM yardage includes standard wood reveal seat and wood outer back only.

Specify:

- Product Number
- Wood Finish
- Back Style
- Seat Style
- Arm Cap Style
- Arm Cap Color
- Fabric Vendor, Pattern and Color

See pages 16 & 17 for material and finish options.

Trace Easy Access Chairs



63541H22 EASY ACCESS CHAIR, 22" SEAT, METAL FRAME

W: 26" D: 24.25" H: 36" SW: 22" SD: 16" SH: 21.5" AH: 27.75" WT: 36 lb COM: 1.75 yd WT CAP: 550 lb

ZONE	B/COM	C	D	E	F	G	H	I	J	GENERAL INFORMATION
1	3039	3074	3107	3149	3219	3288	3358	3426	3496	MATERIAL: Metal MOIS. BARR: \$21
2	3114	3149	3182	3224	3294	3363	3433	3501	3571	
3	3190	3225	3258	3300	3370	3439	3509	3577	3647	
4	3265	3300	3333	3375	3445	3514	3584	3652	3722	

COM yardage includes standard wood reveal seat and wood outer back only.

63541H30 EASY ACCESS CHAIR, 30" SEAT, METAL FRAME

W: 34" D: 24.25" H: 36" SW: 30" SD: 16" SH: 21.5" AH: 27.75" WT: 43 lb COM: 2 yd WT CAP: 750 lb

ZONE	B/COM	C	D	E	F	G	H	I	J	GENERAL INFORMATION
1	3298	3338	3376	3424	3504	3582	3662	3740	3820	MATERIAL: Metal MOIS. BARR: \$24
2	3380	3420	3458	3506	3586	3664	3744	3822	3902	
3	3461	3501	3539	3587	3667	3745	3825	3903	3983	
4	3543	3583	3621	3669	3749	3827	3907	3985	4065	

COM yardage includes standard wood reveal seat and wood outer back only.

63441H22 EASY ACCESS CHAIR, 22" SEAT, WOOD FRAME

W: 26" D: 24.25" H: 36" SW: 22" SD: 16" SH: 21.5" AH: 27.75" WT: 36 lb COM: 1.75 yd WT CAP: 550 lb

ZONE	B/COM	C	D	E	F	G	H	I	J	GENERAL INFORMATION
1	3039	3074	3107	3149	3219	3288	3358	3426	3496	MATERIAL: Beech MOIS. BARR: \$21
2	3114	3149	3182	3224	3294	3363	3433	3501	3571	
3	3190	3225	3258	3300	3370	3439	3509	3577	3647	
4	3265	3300	3333	3375	3445	3514	3584	3652	3722	

COM yardage includes standard wood reveal seat and wood outer back only.

63441H30 EASY ACCESS CHAIR, 30" SEAT, WOOD FRAME

W: 34" D: 24.25" H: 36" SW: 30" SD: 16" SH: 21.5" AH: 27.75" WT: 43 lb COM: 2 yd WT CAP: 750 lb

ZONE	B/COM	C	D	E	F	G	H	I	J	GENERAL INFORMATION
1	3298	3338	3376	3424	3504	3582	3662	3740	3820	MATERIAL: Beech MOIS. BARR: \$24
2	3380	3420	3458	3506	3586	3664	3744	3822	3902	
3	3461	3501	3539	3587	3667	3745	3825	3903	3983	
4	3543	3583	3621	3669	3749	3827	3907	3985	4065	

COM yardage includes standard wood reveal seat and wood outer back only.

Specify:

- Product Number
- Wood Finish
- Back Style
- Seat Style
- Arm Cap Style
- Arm Cap Color
- Fabric Vendor,
Pattern and Color

**See pages 16 & 17
for material and finish
options.**

Trace Tables



6300001 WOOD END TABLE

W: 20" D: 20" H: 21" WT: 27 lb

GENERAL INFORMATION

MATERIAL: Beech
MOIS. BARR: -

ZONE	Thermoform	Laminate/Wood Edge	Veneer Top/Wood Edge
1	1231	1730	1929
2	1262	1773	1977
3	1293	1816	2025
4	1323	1860	2074

Available with thermoform, laminate or wood veneer top. Solid surface top available on metal end table model only.

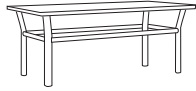

6300002 WOOD COFFEE TABLE

W: 40" D: 20" H: 16" WT: 42 lb

GENERAL INFORMATION

MATERIAL: Beech
MOIS BARR: -

ZONE	Thermoform	Laminate/Wood Edge	Veneer Top/Wood Edge
1	1539	2158	2468
2	1577	2212	2530
3	1616	2266	2591
4	1654	2320	2653

Available with thermoform, laminate or wood veneer top. Solid surface top available on metal end table model only.

6300051 METAL END TABLE

W: 20" D: 20" H: 21" WT: 20 lb

GENERAL INFORMATION

MATERIAL: Metal
MOIS BARR: -

ZONE	Thermoform	Solid Surface	Laminate/Wood Edge	Veneer Top/Wood Edge
1	1231	1929	1730	1929
2	1262	1977	1773	1977
3	1293	2025	1816	2025
4	1323	2074	1860	2074

Available with thermoform, solid surface, laminate, or wood veneer top. Solid surface pricing is for standard colors only. See Ordering Information for additional details.



Thermoform edge



Solid surface edge



Laminate edge



Wood edge

Specify:

- Product Number
- Edge Profile
- Wood Finish
- Thermoform Finish
- Solid Surface Color
- Edge Style and Finish
- Laminate Vendor, Pattern and Finish

See pages 16 & 17 for material and finish options.

SEAT OPTIONS



Specify black or sterling grey.



BACK OPTIONS



Specify black, light grey or white.



Available on poly and upholstered seat models. Specify wood finish (Maple) and design.

PLASTIC BACK PANEL COLORS



WOOD BACK DESIGNS



Specify wood finish (Maple).

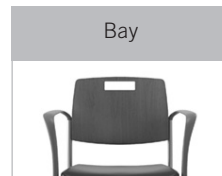

Specify wood finish (Maple).

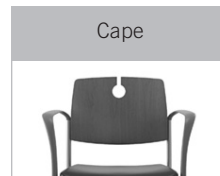

Specify wood finish (Maple).

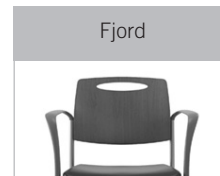

Specify wood finish (Maple).

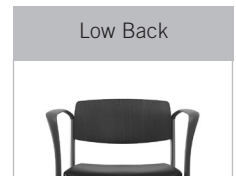

Specify wood finish (Maple). Low back style only available on four-leg models without arms.

ARM OPTIONS



FRAME OPTIONS



Specify color. Frame options available in 7 colors to match metal finishes.



Available on four-leg chairs only.

OPTIONS



Upland Poly Seat/Plastic Back



69UP01 ARM CHAIR, POLY SEAT, PLASTIC BACK

W: 24" D: 22" H: 32.5" SW: 18" SD: - SH: 18" AH: 27" WT: 16 lb COM: - WT CAP: 500 lb

Zone	1	2	3	4	GENERAL INFORMATION
	572	586	601	615	MATERIAL: Metal MOIS. BARR: -

Wood back option available. Chairs stack 8 high with dolly.



69UP11 SIDE CHAIR, POLY SEAT, PLASTIC BACK

W: 20.25" D: 22" H: 32.5" SW: 18" SD: - SH: 18" AH: - WT: 15 lb COM: - WT CAP: 500 lb

Zone	1	2	3	4	GENERAL INFORMATION
	572	586	601	615	MATERIAL: Metal MOIS. BARR: -

Wood back option available, including low back. Chairs stack 8 high with dolly.

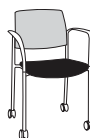

69UP02 ARM CHAIR, POLY SEAT, PLASTIC BACK, CASTERS

W: 24" D: 22" H: 32.5" SW: 18" SD: - SH: 18" AH: 27" WT: 17 lb COM: - WT CAP: 250 lb

Zone	1	2	3	4	GENERAL INFORMATION
	786	806	825	845	MATERIAL: Metal MOIS. BARR: -

Wood back option available. Chairs stack 5 high with dolly.



69UP31 ARM CHAIR, POLY SEAT, PLASTIC BACK, SLED BASE

W: 24" D: 22" H: 32.5" SW: 18" SD: - SH: 18" AH: 27" WT: 18 lb COM: - WT CAP: 500 lb

Zone	1	2	3	4	GENERAL INFORMATION
	727	745	763	782	MATERIAL: Metal MOIS. BARR: -

Wood back option available. Sled base models do not stack.



69UP41 SIDE CHAIR, POLY SEAT, PLASTIC BACK, SLED BASE

W: 20.25" D: 22" H: 32.5" SW: 18" SD: - SH: 18" AH: - WT: 17 lb COM: - WT CAP: 500 lb

Zone	1	2	3	4	GENERAL INFORMATION
	727	745	763	782	MATERIAL: Metal MOIS. BARR: -

Wood back option available. Sled base models do not stack.

Specify:

- Product Number
- Seat Finish
- Back Finish
- Back Panel Finish
- Arm Cap Color
- Metal Finish

See pages 16 & 17 for material and finish options.

Upland Poly Seat/Plastic Back



69UP04 ARM CHAIR, WIDE, POLY SEAT, PLASTIC BACK

W: 27.75" D: 22" H: 32.5" SW: 22" SD: - SH: 18" AH: 27" WT: 18 lb COM: - WT CAP: 500 lb

Zone	1	2	3	4	GENERAL INFORMATION
	804	824	844	864	MATERIAL: Metal MOIS. BARR: -

Wood back option available. Chairs stack 4 high with dolly.



69UP14 SIDE CHAIR, WIDE, POLY SEAT, PLASTIC BACK

W: 24" D: 22" H: 32.5" SW: 22" SD: - SH: 18" AH: - WT: 17 lb COM: - WT CAP: 500 lb

Zone	1	2	3	4	GENERAL INFORMATION
	804	824	844	864	MATERIAL: Metal MOIS. BARR: -

Wood back option available, including low back. Chairs stack 4 high with dolly.



69UP34 ARM CHAIR, WIDE, POLY SEAT, PLASTIC BACK, SLED BASE

W: 27.75" D: 22" H: 32.5" SW: 22" SD: - SH: 18" AH: 27" WT: 20 lb COM: - WT CAP: 500 lb

Zone	1	2	3	4	GENERAL INFORMATION
	959	983	1007	1031	MATERIAL: Metal MOIS. BARR: -

Wood back option available. Sled base models do not stack.



69UP44 SIDE CHAIR, WIDE, POLY SEAT, PLASTIC BACK, SLED BASE

W: 24" D: 22" H: 32.5" SW: 22" SD: - SH: 18" AH: - WT: 19 lb COM: - WT CAP: 500 lb

Zone	1	2	3	4	GENERAL INFORMATION
	959	983	1007	1031	MATERIAL: Metal MOIS. BARR: -

Wood back option available. Sled base models do not stack.

Specify:

- Product Number
- Seat Finish
- Back Finish
- Back Panel Finish
- Arm Cap Color
- Metal Finish

See pages 16 & 17 for material and finish options.

Upland Poly Seat/Uph Back



69UP01UB ARM CHAIR, POLY SEAT, UPH BACK

W: 24"	D: 22"	H: 32.5"	SW: 18"	SD: -	SH: 18"	AH: 27"	WT: 16 lb	COM: .5 yd	WT CAP: 500 lb	
ZONE	B/COM	C	D	E	F	G	H	I	J	GENERAL INFORMATION
1	647	657	667	679	699	718	738	758	778	MATERIAL: Metal
2	663	673	683	695	715	734	754	774	794	MOIS. BARR: -
3	679	689	699	711	731	750	770	790	810	
4	695	705	715	727	747	766	786	806	826	

Chairs stack 8 high with dolly.



69UP11UB SIDE CHAIR, POLY SEAT, UPH BACK

W: 20.25"	D: 22"	H: 32.5"	SW: 18"	SD: -	SH: 18"	AH: -	WT: 15 lb	COM: .5 yd	WT CAP: 500 lb	
ZONE	B/COM	C	D	E	F	G	H	I	J	GENERAL INFORMATION
1	647	657	667	679	699	718	738	758	778	MATERIAL: Metal
2	663	673	683	695	715	734	754	774	794	MOIS. BARR: -
3	679	689	699	711	731	750	770	790	810	
4	695	705	715	727	747	766	786	806	826	

Chairs stack 8 high with dolly.



69UP02UB ARM CHAIR, POLY SEAT, UPH BACK, CASTERS

W: 24"	D: 22"	H: 32.5"	SW: 18"	SD: -	SH: 18"	AH: 27"	WT: 17 lb	COM: .5 yd	WT CAP: 250 lb	
ZONE	B/COM	C	D	E	F	G	H	I	J	GENERAL INFORMATION
1	860	870	880	892	912	931	951	971	991	MATERIAL: Metal
2	881	891	901	913	933	952	972	992	1012	MOIS. BARR: -
3	903	913	923	935	955	974	994	1014	1034	
4	924	934	944	956	976	995	1015	1035	1055	

Chairs stack 5 high with dolly.



69UP31UB ARM CHAIR, POLY SEAT, UPH BACK, SLED BASE

W: 24"	D: 22"	H: 32.5"	SW: 18"	SD: -	SH: 18"	AH: 27"	WT: 18 lb	COM: .5 yd	WT CAP: 500 lb	
ZONE	B/COM	C	D	E	F	G	H	I	J	GENERAL INFORMATION
1	800	810	820	832	852	871	891	911	931	MATERIAL: Metal
2	820	830	840	852	872	891	911	931	951	MOIS. BARR: -
3	840	850	860	872	892	911	931	951	971	
4	859	869	879	891	911	930	950	970	990	

Sled base models do not stack.



69UP41UB SIDE CHAIR, POLY SEAT, UPH BACK, SLED BASE

W: 20.25"	D: 22"	H: 32.5"	SW: 18"	SD: -	SH: 18"	AH: -	WT: 17 lb	COM: .5 yd	WT CAP: 500 lb	
ZONE	B/COM	C	D	E	F	G	H	I	J	GENERAL INFORMATION
1	800	810	820	832	852	871	891	911	931	MATERIAL: Metal
2	820	830	840	852	872	891	911	931	951	MOIS. BARR: -
3	840	850	860	872	892	911	931	951	971	
4	859	869	879	891	911	930	950	970	990	

Sled base models do not stack.

Specify:

- Product Number
- Seat Finish
- Back Finish
- Back Panel Finish
- Arm Cap Color
- Fabric Vendor, Pattern and Color
- Metal Finish

See pages 16 & 17 for material and finish options.

Upland Poly Seat/Uph Back



69UP04UB ARM CHAIR, WIDE, POLY SEAT, UPH BACK

W: 27.75" D: 22" H: 32.5" SW: 22" SD: - SH: 18" AH: 27" WT: 18 lb COM: .75 yd WT CAP: 500 lb

ZONE	B/COM	C	D	E	F	G	H	I	J	GENERAL INFORMATION
1	934	949	963	981	1011	1041	1071	1100	1130	MATERIAL: Metal MOIS. BARR: -
2	957	972	986	1004	1034	1064	1094	1123	1153	
3	980	995	1009	1027	1057	1087	1117	1146	1176	
4	1003	1018	1032	1050	1080	1110	1140	1169	1199	

Chairs stack 4 high with dolly.



69UP14UB SIDE CHAIR, WIDE, POLY SEAT, UPH BACK

W: 24" D: 22" H: 32.5" SW: 22" SD: - SH: 18" AH: - WT: 17 lb COM: .75 yd WT CAP: 500 lb

ZONE	B/COM	C	D	E	F	G	H	I	J	GENERAL INFORMATION
1	934	949	963	981	1011	1041	1071	1100	1130	MATERIAL: Metal MOIS. BARR: -
2	957	972	986	1004	1034	1064	1094	1123	1153	
3	980	995	1009	1027	1057	1087	1117	1146	1176	
4	1003	1018	1032	1050	1080	1110	1140	1169	1199	

Chairs stack 4 high with dolly.



69UP34UB ARM CHAIR, WIDE, POLY SEAT, UPH BACK, SLED BASE

W: 27.75" D: 22" H: 32.5" SW: 22" SD: - SH: 18" AH: 27" WT: 21 lb COM: .75 yd WT CAP: 500 lb

ZONE	B/COM	C	D	E	F	G	H	I	J	GENERAL INFORMATION
1	1089	1104	1118	1136	1166	1196	1226	1255	1285	MATERIAL: Metal MOIS. BARR: -
2	1116	1131	1145	1163	1193	1223	1253	1282	1312	
3	1143	1158	1172	1190	1220	1250	1280	1309	1339	
4	1170	1185	1199	1217	1247	1277	1307	1336	1366	

Sled base models do not stack.



69UP44UB SIDE CHAIR, WIDE, POLY SEAT, UPH BACK, SLED BASE

W: 24" D: 22" H: 32.5" SW: 22" SD: - SH: 18" AH: - WT: 20 lb COM: .75 yd WT CAP: 500 lb

ZONE	B/COM	C	D	E	F	G	H	I	J	GENERAL INFORMATION
1	1089	1104	1118	1136	1166	1196	1226	1255	1285	MATERIAL: Metal MOIS. BARR: -
2	1116	1131	1145	1163	1193	1223	1253	1282	1312	
3	1143	1158	1172	1190	1220	1250	1280	1309	1339	
4	1170	1185	1199	1217	1247	1277	1307	1336	1366	

Sled base models do not stack.

Specify:

- Product Number
- Seat Finish
- Back Finish
- Back Panel Finish
- Arm Cap Color
- Fabric Vendor, Pattern and Color
- Metal Finish

See pages 16 & 17 for material and finish options.

Upland Uph Seat/Plastic Back



69UP01US ARM CHAIR, UPH SEAT, PLASTIC BACK

W: 24"	D: 22"	H: 32.5"	SW: 18"	SD: -	SH: 18"	AH: 27"	WT: 16 lb	COM: .5 yd	WT CAP: 500 lb	
ZONE	B/COM	C	D	E	F	G	H	I	J	GENERAL INFORMATION
1	665	675	685	697	717	736	756	776	796	MATERIAL: Metal
2	681	691	701	713	733	752	772	792	812	MOIS. BARR: -
3	698	708	718	730	750	769	789	809	829	ADD'L 1"
4	714	724	734	746	766	785	805	825	845	SEAT FOAM: \$23

Wood back option available. Chairs stack 8 high with dolly.



69UP11US SIDE CHAIR, UPH SEAT, PLASTIC BACK

W: 20.25"	D: 22"	H: 32.5"	SW: 18"	SD: -	SH: 18"	AH: -	WT: 15 lb	COM: .5 yd	WT CAP: 500 lb	
ZONE	B/COM	C	D	E	F	G	H	I	J	GENERAL INFORMATION
1	665	675	685	697	717	736	756	776	796	MATERIAL: Metal
2	681	691	701	713	733	752	772	792	812	MOIS. BARR: -
3	698	708	718	730	750	769	789	809	829	ADD'L 1"
4	714	724	734	746	766	785	805	825	845	SEAT FOAM: \$23

Wood back option available, including low back. Chairs stack 8 high with dolly.



69UP02US ARM CHAIR, UPH SEAT, PLASTIC BACK, CASTERS

W: 24"	D: 22"	H: 32.5"	SW: 18"	SD: -	SH: 18"	AH: 27"	WT: 17 lb	COM: .5 yd	WT CAP: 250 lb	
ZONE	B/COM	C	D	E	F	G	H	I	J	GENERAL INFORMATION
1	883	893	903	915	935	954	974	994	1014	MATERIAL: Metal
2	905	915	925	937	957	976	996	1016	1036	MOIS. BARR: -
3	927	937	947	959	979	998	1018	1038	1058	ADD'L 1"
4	949	959	969	981	1001	1020	1040	1060	1080	SEAT FOAM: \$23

Wood back option available. Chairs stack 5 high with dolly.



69UP31US ARM CHAIR, UPH SEAT, PLASTIC BACK, SLED BASE

W: 24"	D: 22"	H: 32.5"	SW: 18"	SD: -	SH: 18"	AH: 27"	WT: 18 lb	COM: .5 yd	WT CAP: 500 lb	
ZONE	B/COM	C	D	E	F	G	H	I	J	GENERAL INFORMATION
1	821	831	841	853	873	892	912	932	952	MATERIAL: Metal
2	841	851	861	873	893	912	932	952	972	MOIS. BARR: -
3	862	872	882	894	914	933	953	973	993	ADD'L 1"
4	882	892	902	914	934	953	973	993	1013	SEAT FOAM: \$23

Wood back option available. Sled base models do not stack.

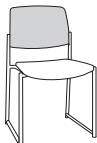

69UP41US SIDE CHAIR, UPH SEAT, PLASTIC BACK, SLED BASE

W: 20.25"	D: 22"	H: 32.5"	SW: 18"	SD: -	SH: 18"	AH: -	WT: 17 lb	COM: .5 yd	WT CAP: 500 lb	
ZONE	B/COM	C	D	E	F	G	H	I	J	GENERAL INFORMATION
1	821	831	841	853	873	892	912	932	952	MATERIAL: Metal
2	841	851	861	873	893	912	932	952	972	MOIS. BARR: -
3	862	872	882	894	914	933	953	973	993	ADD'L 1"
4	882	892	902	914	934	953	973	993	1013	SEAT FOAM: \$23

Wood back option available, including low back. Sled base models do not stack.

Specify:

- Product Number
- Seat Finish
- Back Finish
- Back Panel Finish
- Arm Cap Color
- Fabric Vendor, Pattern and Color
- Metal Finish

See pages 16 & 17 for material and finish options.

Upland Uph Seat/Plastic Back



69UP04US ARM CHAIR, WIDE, UPH SEAT, PLASTIC BACK

W: 27.75" D: 22" H: 32.5" SW: 22" SD: - SH: 18" AH: 27" WT: 18 lb COM: .75 yd WT CAP: 500 lb

ZONE	B/COM	C	D	E	F	G	H	I	J	GENERAL INFORMATION
1	857	872	886	904	934	964	994	1023	1053	MATERIAL: Metal
2	878	893	907	925	955	985	1015	1044	1074	MOIS. BARR: - ADD'L 1"
3	899	914	928	946	976	1006	1036	1065	1095	SEAT FOAM: \$36
4	920	935	949	967	997	1027	1057	1086	1116	

Wood back option available. Chairs stack 4 high with dolly.



69UP14US SIDE CHAIR, WIDE, UPH SEAT, PLASTIC BACK

W: 24" D: 22" H: 32.5" SW: 22" SD: - SH: 18" AH: - WT: 17 lb COM: .75 yd WT CAP: 500 lb

ZONE	B/COM	C	D	E	F	G	H	I	J	GENERAL INFORMATION
1	857	872	886	904	934	964	994	1023	1053	MATERIAL: Metal
2	878	893	907	925	955	985	1015	1044	1074	MOIS. BARR: - ADD'L 1"
3	899	914	928	946	976	1006	1036	1065	1095	SEAT FOAM: \$36
4	920	935	949	967	997	1027	1057	1086	1116	

Wood back option available. Chairs stack 4 high with dolly.



69UP34US ARM CHAIR, WIDE, UPH SEAT, PLASTIC BACK, SLED BASE

W: 27.75" D: 22" H: 32.5" SW: 22" SD: - SH: 18" AH: 27" WT: 21 lb COM: .75 yd WT CAP: 500 lb

ZONE	B/COM	C	D	E	F	G	H	I	J	GENERAL INFORMATION
1	1013	1028	1042	1060	1090	1120	1150	1179	1209	MATERIAL: Metal
2	1038	1053	1067	1085	1115	1145	1175	1204	1234	MOIS. BARR: - ADD'L 1"
3	1063	1078	1092	1110	1140	1170	1200	1229	1259	SEAT FOAM: \$36
4	1088	1103	1117	1135	1165	1195	1225	1254	1284	

Wood back option available. Sled base models do not stack.

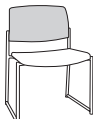

69UP44US SIDE CHAIR, WIDE, UPH SEAT, PLASTIC BACK, SLED BASE

W: 24" D: 22" H: 32.5" SW: 22" SD: - SH: 18" AH: - WT: 20 lb COM: .75 yd WT CAP: 500 lb

ZONE	B/COM	C	D	E	F	G	H	I	J	GENERAL INFORMATION
1	1013	1028	1042	1060	1090	1120	1150	1179	1209	MATERIAL: Metal
2	1038	1053	1067	1085	1115	1145	1175	1204	1234	MOIS. BARR: - ADD'L 1"
3	1063	1078	1092	1110	1140	1170	1200	1229	1259	SEAT FOAM: \$36
4	1088	1103	1117	1135	1165	1195	1225	1254	1284	

Wood back option available. Sled base models do not stack.

Specify:

- Product Number
- Seat Finish
- Back Finish
- Back Panel Finish
- Arm Cap Color
- Fabric Vendor, Pattern and Color
- Metal Finish

See pages 16 & 17 for material and finish options.

Upland Uph Seat/Uph Back



69UP01UP ARM CHAIR, UPH SEAT AND BACK

W: 24"	D: 22"	H: 32.5"	SW: 18"	SD: -	SH: 18"	AH: 27"	WT: 16 lb	COM: 1 yd	WT CAP: 500 lb	
ZONE	B/COM	C	D	E	F	G	H	I	J	GENERAL INFORMATION
1	739	759	778	802	842	881	921	960	1000	MATERIAL: Metal
2	757	777	796	820	860	899	939	978	1018	MOIS. BARR: \$5
3	775	795	814	838	878	917	957	996	1036	ADD'L 1"
4	793	813	832	856	896	935	975	1014	1054	SEAT FOAM: \$23

Chairs stack 8 high with dolly.



69UP11UP SIDE CHAIR, UPH SEAT AND BACK

W: 20.25"	D: 22"	H: 32.5"	SW: 18"	SD: -	SH: 18"	AH: -	WT: 15 lb	COM: 1 yd	WT CAP: 500 lb	
ZONE	B/COM	C	D	E	F	G	H	I	J	GENERAL INFORMATION
1	739	759	778	802	842	881	921	960	1000	MATERIAL: Metal
2	757	777	796	820	860	899	939	978	1018	MOIS. BARR: \$5
3	775	795	814	838	878	917	957	996	1036	ADD'L 1"
4	793	813	832	856	896	935	975	1014	1054	SEAT FOAM: \$23

Chairs stack 8 high with dolly.



69UP02UP ARM CHAIR, UPH SEAT AND BACK, CASTERS

W: 24"	D: 22"	H: 32.5"	SW: 18"	SD: -	SH: 18"	AH: 27"	WT: 17 lb	COM: 1 yd	WT CAP: 250 lb	
ZONE	B/COM	C	D	E	F	G	H	I	J	GENERAL INFORMATION
1	949	969	988	1012	1052	1091	1131	1170	1210	MATERIAL: Metal
2	972	992	1011	1035	1075	1114	1154	1193	1233	MOIS. BARR: \$5
3	996	1016	1035	1059	1099	1138	1178	1217	1257	ADD'L 1"
4	1019	1039	1058	1082	1122	1161	1201	1240	1280	SEAT FOAM: \$23

Chairs stack 5 high with dolly.



69UP31UP ARM CHAIR, UPH SEAT AND BACK, SLED BASE

W: 24"	D: 22"	H: 32.5"	SW: 18"	SD: -	SH: 18"	AH: 27"	WT: 18 lb	COM: 1 yd	WT CAP: 500 lb	
ZONE	B/COM	C	D	E	F	G	H	I	J	GENERAL INFORMATION
1	894	914	933	957	997	1036	1076	1115	1155	MATERIAL: Metal
2	916	936	955	979	1019	1058	1098	1137	1177	MOIS. BARR: \$5
3	938	958	977	1001	1041	1080	1120	1159	1199	ADD'L 1"
4	960	980	999	1023	1063	1102	1142	1181	1221	SEAT FOAM: \$23

Sled base models do not stack.



69UP41UP SIDE CHAIR, UPH SEAT AND BACK, SLED BASE

W: 20.25"	D: 22"	H: 32.5"	SW: 18"	SD: -	SH: 18"	AH: -	WT: 17 lb	COM: 1 yd	WT CAP: 500 lb	
ZONE	B/COM	C	D	E	F	G	H	I	J	GENERAL INFORMATION
1	894	914	933	957	997	1036	1076	1115	1155	MATERIAL: Metal
2	916	936	955	979	1019	1058	1098	1137	1177	MOIS. BARR: \$5
3	938	958	977	1001	1041	1080	1120	1159	1199	ADD'L 1"
4	960	980	999	1023	1063	1102	1142	1181	1221	SEAT FOAM: \$23

Sled base models do not stack.

Specify:

- Product Number
- Back Panel Finish
- Arm Cap Color
- Fabric Vendor, Pattern and Color
- Metal Finish

See pages 16 & 17 for material and finish options.

Upland Uph Seat/Uph Back



69UP04UP ARM CHAIR, WIDE, UPH SEAT AND BACK

W: 27.75" D: 22" H: 32.5" SW: 22" SD: - SH: 18" AH: 27" WT: 18 lb COM: 1.5 yd WT CAP: 500 lb

ZONE	B/COM	C	D	E	F	G	H	I	J	GENERAL INFORMATION
1	988	1018	1047	1083	1143	1201	1261	1320	1380	MATERIAL: Metal
2	1012	1042	1071	1107	1167	1225	1285	1344	1404	MOIS. BARR: \$5
3	1036	1066	1095	1131	1191	1249	1309	1368	1428	ADD'L 1"
4	1060	1090	1119	1155	1215	1273	1333	1392	1452	SEAT FOAM: \$36

Chairs stack 4 high with dolly.



69UP14UP SIDE CHAIR, WIDE, UPH SEAT AND BACK

W: 24" D: 22" H: 32.5" SW: 22" SD: - SH: 18" AH: - WT: 17 lb COM: 1.5 yd WT CAP: 500 lb

ZONE	B/COM	C	D	E	F	G	H	I	J	GENERAL INFORMATION
1	988	1018	1047	1083	1143	1201	1261	1320	1380	MATERIAL: Metal
2	1012	1042	1071	1107	1167	1225	1285	1344	1404	MOIS. BARR: \$5
3	1036	1066	1095	1131	1191	1249	1309	1368	1428	ADD'L 1"
4	1060	1090	1119	1155	1215	1273	1333	1392	1452	SEAT FOAM: \$36

Chairs stack 4 high with dolly.



69UPCSTM26 ARM CHAIR, BARIATRIC, UPH SEAT AND BACK

W: 32" D: 22" H: 32.5" SW: 26" SD: - SH: 18" AH: 27" WT: 22 lb COM: 2 yd WT CAP: 500 lb

ZONE	B/COM	C	D	E	F	G	H	I	J	GENERAL INFORMATION
1	1418	1458	1496	1544	1624	1702	1782	1860	1940	MATERIAL: Metal
2	1453	1493	1531	1579	1659	1737	1817	1895	1975	MOIS. BARR: \$5
3	1487	1527	1565	1613	1693	1771	1851	1929	2009	ADD'L 1"
4	1522	1562	1600	1648	1728	1806	1886	1964	2044	SEAT FOAM: \$34

Chairs stack 4 high with dolly.



69UP34UP ARM CHAIR, WIDE, UPH SEAT AND BACK, SLED BASE

W: 27.75" D: 22" H: 32.5" SW: 22" SD: - SH: 18" AH: 27" WT: 20 lb COM: 1.5 yd WT CAP: 500 lb

ZONE	B/COM	C	D	E	F	G	H	I	J	GENERAL INFORMATION
1	1142	1172	1201	1237	1297	1355	1415	1474	1534	MATERIAL: Metal
2	1170	1200	1229	1265	1325	1383	1443	1502	1562	MOIS. BARR: \$5
3	1198	1228	1257	1293	1353	1411	1471	1530	1590	ADD'L 1"
4	1226	1256	1285	1321	1381	1439	1499	1558	1618	SEAT FOAM: \$36

Sled base models do not stack.



69UP44UP SIDE CHAIR, WIDE, UPH SEAT AND BACK, SLED BASE

W: 24" D: 22" H: 32.5" SW: 22" SD: - SH: 18" AH: - WT: 19 lb COM: 1.5 yd WT CAP: 500 lb

ZONE	B/COM	C	D	E	F	G	H	I	J	GENERAL INFORMATION
1	1142	1172	1201	1237	1297	1355	1415	1474	1534	MATERIAL: Metal
2	1170	1200	1229	1265	1325	1383	1443	1502	1562	MOIS. BARR: \$5
3	1198	1228	1257	1293	1353	1411	1471	1530	1590	ADD'L 1"
4	1226	1256	1285	1321	1381	1439	1499	1558	1618	SEAT FOAM: \$36

Sled base models do not stack.

Specify:

- Product Number
- Back Panel Finish
- Arm Cap Color
- Fabric Vendor, Pattern and Color
- Metal Finish

See pages 16 & 17 for material and finish options.

Upland Easy Access Poly Seat

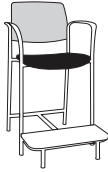

69UP21E EASY ACCESS ARM CHAIR, POLY SEAT, PLASTIC BACK

W: 24" D: 32" H: 38.5" SW: 18" SD: - SH: 24" AH: 33" WT: 21 lb COM: - WT CAP: 500 lb

Zone	1	2	3	4	GENERAL INFORMATION
	837	858	879	900	MATERIAL: Metal MOIS. BARR: -

Wood back option available. Foot rest offered in black only.



69UP24E EASY ACCESS ARM CHAIR, WIDE, POLY SEAT, PLASTIC BACK

W: 27.5" D: 32" H: 38.5" SW: 22" SD: - SH: 24" AH: 33" WT: 23 lb COM: - WT CAP: 500 lb

Zone	1	2	3	4	GENERAL INFORMATION
	1066	1093	1119	1146	MATERIAL: Metal MOIS. BARR: -

Wood back option available. Foot rest offered in black only.



69UP21EUB EASY ACCESS ARM CHAIR, POLY SEAT, UPH BACK

W: 24" D: 32" H: 38.5" SW: 18" SD: - SH: 24" AH: 33" WT: 21 lb COM: .5 yd WT CAP: 500 lb

ZONE	B/COM	C	D	E	F	G	H	I	J	GENERAL INFORMATION
1	913	923	933	945	965	984	1004	1024	1044	MATERIAL: Metal MOIS. BARR: -
2	936	946	956	968	988	1007	1027	1047	1067	
3	958	968	978	990	1010	1029	1049	1069	1089	
4	981	991	1001	1013	1033	1052	1072	1092	1112	

Foot rest offered in black only.



69UP24EUB EASY ACCESS ARM CHAIR, WIDE, POLY SEAT, UPH BACK

W: 27.5" D: 32" H: 38.5" SW: 22" SD: - SH: 24" AH: 33" WT: 23 lb COM: .75 yd WT CAP: 500 lb

ZONE	B/COM	C	D	E	F	G	H	I	J	GENERAL INFORMATION
1	1201	1216	1230	1248	1278	1308	1338	1367	1397	MATERIAL: Metal MOIS. BARR: -
2	1231	1246	1260	1278	1308	1338	1368	1397	1427	
3	1260	1275	1289	1307	1337	1367	1397	1426	1456	
4	1290	1305	1319	1337	1367	1397	1427	1456	1486	

Foot rest offered in black only.

Specify:

- Product Number
- Seat Finish
- Back Finish
- Back Panel Finish
- Arm Cap Color
- Metal Finish

See pages 16 & 17 for material and finish options.

Upland Easy Access Uph Seat



69UP21EUS EASY ACCESS ARM CHAIR, UPH SEAT, PLASTIC BACK

W: 24" D: 32" H: 38.5" SW: 18" SD: - SH: 24" AH: 33" WT: 21 lb COM: .5 yd WT CAP: 500 lb

ZONE	B/COM	C	D	E	F	G	H	I	J	GENERAL INFORMATION
1	929	939	949	961	981	1000	1020	1040	1060	MATERIAL: Metal MOIS. BARR: \$5
2	952	962	972	984	1004	1023	1043	1063	1083	
3	975	985	995	1007	1027	1046	1066	1086	1106	
4	998	1008	1018	1030	1050	1069	1089	1109	1129	

Wood back option available. Foot rest offered in black only.



69UP24EUS EASY ACCESS ARM CHAIR, WIDE, UPH SEAT, PLASTIC BACK

W: 27.75" D: 32" H: 38.5" SW: 22" SD: - SH: 24" AH: 33" WT: 23 lb COM: .75 yd WT CAP: 500 lb

ZONE	B/COM	C	D	E	F	G	H	I	J	GENERAL INFORMATION
1	1124	1139	1153	1171	1201	1231	1261	1290	1320	MATERIAL: Metal MOIS. BARR: \$5
2	1152	1167	1181	1199	1229	1259	1289	1318	1348	
3	1180	1195	1209	1227	1257	1287	1317	1346	1376	
4	1207	1222	1236	1254	1284	1314	1344	1373	1403	

Wood back option available. Foot rest offered in black only.



69UP21EUP EASY ACCESS ARM CHAIR, UPH SEAT AND BACK

W: 24" D: 32" H: 38.5" SW: 18" SD: - SH: 24" AH: 33" WT: 21 lb COM: 1 yd WT CAP: 500 lb

ZONE	B/COM	C	D	E	F	G	H	I	J	GENERAL INFORMATION
1	1003	1023	1042	1066	1106	1145	1185	1224	1264	MATERIAL: Metal MOIS. BARR: \$5
2	1028	1048	1067	1091	1131	1170	1210	1249	1289	
3	1052	1072	1091	1115	1155	1194	1234	1273	1313	
4	1077	1097	1116	1140	1180	1219	1259	1298	1338	

Foot rest offered in black only.



69UP24EUP EASY ACCESS ARM CHAIR, WIDE, UPH SEAT AND BACK

W: 27.75" D: 32" H: 38.5" SW: 22" SD: - SH: 24" AH: 33" WT: 23 lb COM: 1.5 yd WT CAP: 500 lb

ZONE	B/COM	C	D	E	F	G	H	I	J	GENERAL INFORMATION
1	1254	1284	1313	1349	1409	1467	1527	1586	1646	MATERIAL: Metal MOIS. BARR: \$5
2	1285	1315	1344	1380	1440	1498	1558	1617	1677	
3	1316	1346	1375	1411	1471	1529	1589	1648	1708	
4	1346	1376	1405	1441	1501	1559	1619	1678	1738	

Foot rest offered in black only.

Specify:

- Product Number
- Seat Finish
- Back Finish
- Back Panel Finish
- Arm Cap Color
- Fabric Vendor, Pattern and Color
- Metal Finish

See pages 16 & 17 for material and finish options.

Upland Poly Seat/Plastic Back Bar Stools



69UP21 BAR STOOL W/ ARMS, POLY SEAT, PLASTIC BACK

W: 24"	D: 22"	H: 43.5"	SW: 18"	SD: -	SH: 28"	AH: 37"	WT: 21 lb	COM: -	WT CAP: 500 lb
Zone		1	2	3	4	GENERAL INFORMATION			
		770	789	808	828	MATERIAL: Metal MOIS. BARR: -			

Wood back option available.



69UP25 BAR STOOL, POLY SEAT, PLASTIC BACK

W: 20.25"	D: 22"	H: 43.5"	SW: 18"	SD: -	SH: 28"	AH: -	WT: 20 lb	COM: -	WT CAP: 500 lb
Zone		1	2	3	4	GENERAL INFORMATION			
		770	789	808	828	MATERIAL: Metal MOIS. BARR: -			

Wood back option available, including low back.



69UP24 BAR STOOL W/ ARMS, WIDE, POLY SEAT, PLASTIC BACK

W: 27.75"	D: 22"	H: 43.5"	SW: 22"	SD: -	SH: 28"	AH: 36"	WT: 23 lb	COM: -	WT CAP: 500 lb
Zone		1	2	3	4	GENERAL INFORMATION			
		999	1024	1049	1074	MATERIAL: Metal MOIS. BARR: -			

Wood back option available.



69UP26 BAR STOOL, WIDE, POLY SEAT, PLASTIC BACK

W: 24"	D: 22"	H: 43.5"	SW: 22"	SD: -	SH: 28"	AH: -	WT: 22 lb	COM: -	WT CAP: 500 lb
Zone		1	2	3	4	GENERAL INFORMATION			
		999	1024	1049	1074	MATERIAL: Metal MOIS. BARR: -			

Wood back option available, including low back.

Specify:

- Product Number
- Seat Finish
- Back Finish
- Back Panel Finish
- Arm Cap Color
- Metal Finish

See pages 16 & 17 for material and finish options.

Upland Poly Seat/Uph Back Bar Stools



69UP21UB BAR STOOL W/ ARMS, POLY SEAT, UPH BACK

W: 24" D: 22" H: 43.5" SW: 18" SD: - SH: 28" AH: 37" WT: 21 lb COM: .5 yd WT CAP: 500 lb

ZONE	B/COM	C	D	E	F	G	H	I	J	GENERAL INFORMATION
1	844	854	864	876	896	915	935	955	975	MATERIAL: Metal MOIS. BARR: -
2	865	875	885	897	917	936	956	976	996	
3	886	896	906	918	938	957	977	997	1017	
4	907	917	927	939	959	978	998	1018	1038	



69UP25UB BAR STOOL, POLY SEAT, UPH BACK

W: 20.25" D: 22" H: 43.5" SW: 18" SD: - SH: 28" AH: - WT: 20 lb COM: .5 yd WT CAP: 500 lb

ZONE	B/COM	C	D	E	F	G	H	I	J	GENERAL INFORMATION
1	844	854	864	876	896	915	935	955	975	MATERIAL: Metal MOIS. BARR: -
2	865	875	885	897	917	936	956	976	996	
3	886	896	906	918	938	957	977	997	1017	
4	907	917	927	939	959	978	998	1018	1038	



69UP24UB BAR STOOL, WIDE W/ ARMS, POLY SEAT, UPH BACK

W: 27.75" D: 22" H: 43.5" SW: 22" SD: - SH: 28" AH: 37" WT: 21 lb COM: .75 yd WT CAP: 500 lb

ZONE	B/COM	C	D	E	F	G	H	I	J	GENERAL INFORMATION
1	1131	1146	1160	1178	1208	1238	1268	1297	1327	MATERIAL: Metal MOIS. BARR: -
2	1159	1174	1188	1206	1236	1266	1296	1325	1355	
3	1187	1202	1216	1234	1264	1294	1324	1353	1383	
4	1215	1230	1244	1262	1292	1322	1352	1381	1411	



69UP26UB BAR STOOL, WIDE, POLY SEAT, UPH BACK

W: 24" D: 22" H: 43.5" SW: 22" SD: - SH: 28" AH: - WT: 20 lb COM: .75 yd WT CAP: 500 lb

ZONE	B/COM	C	D	E	F	G	H	I	J	GENERAL INFORMATION
1	1131	1146	1160	1178	1208	1238	1268	1297	1327	MATERIAL: Metal MOIS. BARR: -
2	1159	1174	1188	1206	1236	1266	1296	1325	1355	
3	1187	1202	1216	1234	1264	1294	1324	1353	1383	
4	1215	1230	1244	1262	1292	1322	1352	1381	1411	

Specify:

- Product Number
- Seat Finish
- Back Panel Finish
- Arm Cap Color
- Fabric Vendor, Pattern and Color
- Metal Finish

See pages 16 & 17 for material and finish options.

Upland Uph Seat/Plastic Back Bar Stools



69UP21US BAR STOOL W/ ARMS, UPH SEAT, PLASTIC BACK

W: 24"	D: 22"	H: 43.5"	SW: 18"	SD: -	SH: 28"	AH: 37"	WT: 21 lb	COM: .5 yd	WT CAP: 500 lb	
ZONE	B/COM	C	D	E	F	G	H	I	J	GENERAL INFORMATION
1	862	872	882	894	914	933	953	973	993	MATERIAL: Metal
2	883	893	903	915	935	954	974	994	1014	MOIS. BARR: -
3	905	915	925	937	957	976	996	1016	1036	ADD'L 1"
4	926	936	946	958	978	997	1017	1037	1057	SEAT FOAM: \$23

Wood back option available.



69UP25US BAR STOOL, UPH SEAT, PLASTIC BACK

W: 20.25"	D: 22"	H: 43.5"	SW: 18"	SD: -	SH: 28"	AH: -	WT: 20 lb	COM: .5 yd	WT CAP: 500 lb	
ZONE	B/COM	C	D	E	F	G	H	I	J	GENERAL INFORMATION
1	862	872	882	894	914	933	953	973	993	MATERIAL: Metal
2	883	893	903	915	935	954	974	994	1014	MOIS. BARR: -
3	905	915	925	937	957	976	996	1016	1036	ADD'L 1"
4	926	936	946	958	978	997	1017	1037	1057	SEAT FOAM: \$23

Wood back option available, including low back.



69UP24US BAR STOOL W/ ARMS, WIDE, UPH SEAT, PLASTIC BACK

W: 27.75"	D: 22"	H: 43.5"	SW: 22"	SD: -	SH: 28"	AH: 37"	WT: 23 lb	COM: .75 yd	WT CAP: 500 lb	
ZONE	B/COM	C	D	E	F	G	H	I	J	GENERAL INFORMATION
1	1056	1071	1085	1103	1133	1163	1193	1222	1252	MATERIAL: Metal
2	1082	1097	1111	1129	1159	1189	1219	1248	1278	MOIS. BARR: -
3	1108	1123	1137	1155	1185	1215	1245	1274	1304	ADD'L 1"
4	1134	1149	1163	1181	1211	1241	1271	1300	1330	SEAT FOAM: \$36

Wood back option available.



69UP26US BAR STOOL, WIDE, UPH SEAT, PLASTIC BACK

W: 24"	D: 22"	H: 43.5"	SW: 22"	SD: -	SH: 28"	AH: -	WT: 22 lb	COM: .75 yd	WT CAP: 500 lb	
ZONE	B/COM	C	D	E	F	G	H	I	J	GENERAL INFORMATION
1	1056	1071	1085	1103	1133	1163	1193	1222	1252	MATERIAL: Metal
2	1082	1097	1111	1129	1159	1189	1219	1248	1278	MOIS. BARR: -
3	1108	1123	1137	1155	1185	1215	1245	1274	1304	ADD'L 1"
4	1134	1149	1163	1181	1211	1241	1271	1300	1330	SEAT FOAM: \$36

Wood back option available, including low back.

Specify:

- Product Number
- Back Finish
- Back Panel Finish
- Arm Cap Color
- Fabric Vendor, Pattern and Color
- Metal Finish

See pages 16 & 17 for material and finish options.

Upland Uph Seat/Uph Back Bar Stools



69UP21UP BAR STOOL W/ ARMS, UPH SEAT AND BACK

W: 24" D: 22" H: 43.5" SW: 18" SD: - SH: 28" AH: 37" WT: 21 lb COM: 1 yd WT CAP: 500 lb

ZONE	B/COM	C	D	E	F	G	H	I	J	GENERAL INFORMATION
1	935	955	974	998	1038	1077	1117	1156	1196	MATERIAL: Metal
2	958	978	997	1021	1061	1100	1140	1179	1219	MOIS. BARR: \$5
3	981	1001	1020	1044	1084	1123	1163	1202	1242	ADD'L 1"
4	1004	1024	1043	1067	1107	1146	1186	1225	1265	SEAT FOAM: \$23

Wood back option available.



69UP25UP BAR STOOL, UPH SEAT AND BACK

W: 20.25" D: 22" H: 43.5" SW: 18" SD: - SH: 28" AH: - WT: 20 lb COM: 1 yd WT CAP: 500 lb

ZONE	B/COM	C	D	E	F	G	H	I	J	GENERAL INFORMATION
1	935	955	974	998	1038	1077	1117	1156	1196	MATERIAL: Metal
2	958	978	997	1021	1061	1100	1140	1179	1219	MOIS. BARR: \$5
3	981	1001	1020	1044	1084	1123	1163	1202	1242	ADD'L 1"
4	1004	1024	1043	1067	1107	1146	1186	1225	1265	SEAT FOAM: \$23

Wood back option available.



69UP24UP BAR STOOL W/ ARMS, WIDE, UPH SEAT AND BACK

W: 27.75" D: 22" H: 43.5" SW: 22" SD: - SH: 28" AH: 37" WT: 23 lb COM: 1.5 yd WT CAP: 500 lb

ZONE	B/COM	C	D	E	F	G	H	I	J	GENERAL INFORMATION
1	1185	1215	1244	1280	1340	1398	1458	1517	1577	MATERIAL: Metal
2	1214	1244	1273	1309	1369	1427	1487	1546	1606	MOIS. BARR: \$5
3	1243	1273	1302	1338	1398	1456	1516	1575	1635	ADD'L 1"
4	1272	1302	1331	1367	1427	1485	1545	1604	1664	SEAT FOAM: \$36

Wood back option available.



69UP26UP BAR STOOL, WIDE, UPH SEAT AND BACK

W: 24" D: 22" H: 43.5" SW: 22" SD: - SH: 28" AH: - WT: 22 lb COM: 1.5 yd WT CAP: 500 lb

ZONE	B/COM	C	D	E	F	G	H	I	J	GENERAL INFORMATION
1	1185	1215	1244	1280	1340	1398	1458	1517	1577	MATERIAL: Metal
2	1214	1244	1273	1309	1369	1427	1487	1546	1606	MOIS. BARR: \$5
3	1243	1273	1302	1338	1398	1456	1516	1575	1635	ADD'L 1"
4	1272	1302	1331	1367	1427	1485	1545	1604	1664	SEAT FOAM: \$36

Wood back option available.

Accessories



69UP99 DOLLY, STANDARD

W: 22.5" D: 34" H: 37" WT: 20 lb

Zone 1	Zone 2	Zone 3	Zone 4
\$552	\$566	\$580	\$593

69UP99M DOLLY, WIDE

W: 32.5" D: 34" H: 37" WT: 25 lb

Zone 1	Zone 2	Zone 3	Zone 4
\$791	\$811	\$831	\$850



69UP14CON CONNECTING BAR - GANGING

\$129

Add one bar for each chair. Connecting bar will match frame color.

Specify:

- Product Number
- Back Panel Finish
- Arm Cap Color
- Fabric Vendor, Pattern and Color
- Metal Finish
- Edge Style and Finish
- Laminate Vendor, Pattern and Finish

See pages 16 & 17 for material and finish options.

Upland Tables



69UP14RC CORNER TABLE, MODULAR

W: 25" D: 25" H: 17.5" WT: 13 lb

GENERAL INFORMATION

MATERIAL: Laminate
MOIS. BARR: -

	All Zones
	529

Specify edge style and finish when ordering.



69UP14ST SPACER TABLE, MODULAR

W: 17" D: 17" H: 17.5" WT: 8 lb

GENERAL INFORMATION

MATERIAL: Laminate
MOIS. BARR: -

	All Zones
	364

Specify edge style and finish when ordering.



69UP14MT MINI SPACER TABLE, MODULAR

W: 4.5" D: 14.5" H: 17.5" WT: 3 lb

GENERAL INFORMATION

MATERIAL: Laminate
MOIS. BARR: -

	All Zones
	216

Specify edge style and finish when ordering.



69UP14ET END TABLE, MODULAR

W: 17" D: 17" H: 17.5" WT: 13 lb

GENERAL INFORMATION

MATERIAL: Laminate
MOIS. BARR: -

	All Zones
	377

Specify edge style and finish when ordering.

Edge Style Options



FLAT PVC EDGE

Available in 7 colors to match metal finishes.



SELF EDGE

Matches top laminate.



2MM BIO EDGE

Available in 7 colors to match metal finishes.



2MM PVC WOOD GRAIN EDGE

Available in 9 wood grain colors to match standard laminates.

Specify:

- Product Number
- Metal Finish
- Edge Style and Finish
- Laminate Vendor, Pattern and Finish

See pages 16 & 17 for material and finish options.

Versant Glider



54151WG20 GLIDER, 20" SEAT, UPH ARM, WOOD CAP, SHORT SKIRT

W: 27.5" D: 30" H: 42" SW: 20" SD: 19.5" SH: 18.5" AH: 24.75" WT: 63 lb COM: 4 yd WT CAP: 350 lb

ZONE	B/COM	C	D	E	F	G	H	I	J	GENERAL INFORMATION
1	4301	4381	4457	4553	4713	4869	5029	5185	5345	MATERIAL: Maple
2	4407	4487	4563	4659	4819	4975	5135	5291	5451	MOIS. BARR: Included
3	4513	4593	4669	4765	4925	5081	5241	5397	5557	
4	4619	4699	4775	4871	5031	5187	5347	5503	5663	

54151WG22 GLIDER, 22" SEAT, UPH ARM, WOOD CAP, SHORT SKIRT

W: 29.5" D: 30" H: 42" SW: 22" SD: 19.5" SH: 18.5" AH: 24.75" WT: 66 lb COM: 4 yd WT CAP: 350 lb

ZONE	B/COM	C	D	E	F	G	H	I	J	GENERAL INFORMATION
1	4477	4557	4633	4729	4889	5045	5205	5361	5521	MATERIAL: Maple
2	4587	4667	4743	4839	4999	5155	5315	5471	5631	MOIS. BARR: Included
3	4698	4778	4854	4950	5110	5266	5426	5582	5742	
4	4808	4888	4964	5060	5220	5376	5536	5692	5852	

54151WG24 GLIDER, 24" SEAT, UPH ARM, WOOD CAP, SHORT SKIRT

W: 31.5" D: 30" H: 42" SW: 24" SD: 19.5" SH: 18.5" AH: 24.75" WT: 69 lb COM: 4.25 yd WT CAP: 350 lb

ZONE	B/COM	C	D	E	F	G	H	I	J	GENERAL INFORMATION
1	4670	4755	4836	4938	5108	5274	5444	5609	5779	MATERIAL: Maple
2	4785	4870	4951	5053	5223	5389	5559	5724	5894	MOIS. BARR: Included
3	4900	4985	5066	5168	5338	5504	5674	5839	6009	
4	5015	5100	5181	5283	5453	5619	5789	5954	6124	



54151UG20 GLIDER, 20" SEAT, UPH ARM, URETHANE CAP, SHORT SKIRT

W: 27.5" D: 30" H: 42" SW: 20" SD: 19.5" SH: 18.5" AH: 24.75" WT: 63 lb COM: 4 yd WT CAP: 350 lb

ZONE	B/COM	C	D	E	F	G	H	I	J	GENERAL INFORMATION
1	4301	4381	4457	4553	4713	4869	5029	5185	5345	MATERIAL: -
2	4407	4487	4563	4659	4819	4975	5135	5291	5451	MOIS. BARR: Included
3	4513	4593	4669	4765	4925	5081	5241	5397	5557	
4	4619	4699	4775	4871	5031	5187	5347	5503	5663	

Urethane arm caps are available in black, sable or dove.

54151UG22 GLIDER, 22" SEAT, UPH ARM, URETHANE CAP, SHORT SKIRT

W: 29.5" D: 30" H: 42" SW: 22" SD: 19.5" SH: 18.5" AH: 24.75" WT: 66 lb COM: 4 yd WT CAP: 350 lb

ZONE	B/COM	C	D	E	F	G	H	I	J	GENERAL INFORMATION
1	4477	4557	4633	4729	4889	5045	5205	5361	5521	MATERIAL: -
2	4587	4667	4743	4839	4999	5155	5315	5471	5631	MOIS. BARR: Included
3	4698	4778	4854	4950	5110	5266	5426	5582	5742	
4	4808	4888	4964	5060	5220	5376	5536	5692	5852	

Urethane arm caps are available in black, sable or dove.

54151UG24 GLIDER, 24" SEAT, UPH ARM, URETHANE CAP, SHORT SKIRT

W: 31.5" D: 30" H: 42" SW: 24" SD: 19.5" SH: 18.5" AH: 24.75" WT: 69 lb COM: 4.25 yd WT CAP: 350 lb

ZONE	B/COM	C	D	E	F	G	H	I	J	GENERAL INFORMATION
1	4670	4755	4836	4938	5108	5274	5444	5609	5779	MATERIAL: -
2	4785	4870	4951	5053	5223	5389	5559	5724	5894	MOIS. BARR: Included
3	4900	4985	5066	5168	5338	5504	5674	5839	6009	
4	5015	5100	5181	5283	5453	5619	5789	5954	6124	

Urethane arm caps are available in black, sable or dove.

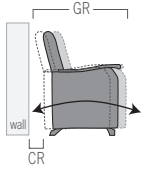

GR- Glider range from forward point to rear point is 41"

CR- Clearance required when placed against a wall is 7"

Specify:

- Product Number
- Wood Finish
- Urethane Cap Color
- Fabric Vendor, Pattern and Color

See pages 16 & 17 for material and finish options.

Versant Glider



54151WLG20 GLIDER, 20" SEAT, UPH ARM, WOOD CAP, SHORT SKIRT, LOCKING MECHANISM

W: 27.5" D: 30" H: 42" SW: 20" SD: 19.5" SH: 18.5" AH: 24.75" WT: 65 lb COM: 4 yd WT CAP: 350 lb

ZONE	B/COM	C	D	E	F	G	H	I	J	GENERAL INFORMATION
1	4574	4654	4730	4826	4986	5142	5302	5458	5618	MATERIAL: Maple MOIS. BARR: Included
2	4687	4767	4843	4939	5099	5255	5415	5571	5731	
3	4800	4880	4956	5052	5212	5368	5528	5684	5844	
4	4912	4992	5068	5164	5324	5480	5640	5796	5956	

54151WLG22 GLIDER, 22" SEAT, UPH ARM, WOOD CAP, SHORT SKIRT, LOCKING MECHANISM

W: 29.5" D: 30" H: 42" SW: 22" SD: 19.5" SH: 18.5" AH: 24.75" WT: 68 lb COM: 4 yd WT CAP: 350 lb

ZONE	B/COM	C	D	E	F	G	H	I	J	GENERAL INFORMATION
1	4764	4844	4920	5016	5176	5332	5492	5648	5808	MATERIAL: Maple MOIS. BARR: Included
2	4882	4962	5038	5134	5294	5450	5610	5766	5926	
3	4999	5079	5155	5251	5411	5567	5727	5883	6043	
4	5116	5196	5272	5368	5528	5684	5844	6000	6160	

54151WLG24 GLIDER, 24" SEAT, UPH ARM, WOOD CAP, SHORT SKIRT, LOCKING MECHANISM

W: 31.5" D: 30" H: 42" SW: 24" SD: 19.5" SH: 18.5" AH: 24.75" WT: 71 lb COM: 4.25 yd WT CAP: 350 lb

ZONE	B/COM	C	D	E	F	G	H	I	J	GENERAL INFORMATION
1	4969	5054	5135	5237	5407	5573	5743	5908	6078	MATERIAL: Maple MOIS. BARR: Included
2	5092	5177	5258	5360	5530	5696	5866	6031	6201	
3	5214	5299	5380	5482	5652	5818	5988	6153	6323	
4	5337	5422	5503	5605	5775	5941	6111	6276	6446	



54151ULG20 GLIDER, 20" SEAT, UPH ARM, URETHANE CAP, SHORT SKIRT, LOCKING MECHANISM

W: 27.5" D: 30" H: 42" SW: 20" SD: 19.5" SH: 18.5" AH: 24.75" WT: 65 lb COM: 4 yd WT CAP: 350 lb

ZONE	B/COM	C	D	E	F	G	H	I	J	GENERAL INFORMATION
1	4574	4654	4730	4826	4986	5142	5302	5458	5618	MATERIAL: - MOIS. BARR: Included
2	4687	4767	4843	4939	5099	5255	5415	5571	5731	
3	4800	4880	4956	5052	5212	5368	5528	5684	5844	
4	4912	4992	5068	5164	5324	5480	5640	5796	5956	

Urethane arm caps are available in black, sable or dove.

54151ULG22 GLIDER, 22" SEAT, UPH ARM, URETHANE CAP, SHORT SKIRT, LOCKING MECHANISM

W: 29.5" D: 30" H: 42" SW: 22" SD: 19.5" SH: 18.5" AH: 24.75" WT: 68 lb COM: 4 yd WT CAP: 350 lb

ZONE	B/COM	C	D	E	F	G	H	I	J	GENERAL INFORMATION
1	4764	4844	4920	5016	5176	5332	5492	5648	5808	MATERIAL: - MOIS. BARR: Included
2	4882	4962	5038	5134	5294	5450	5610	5766	5926	
3	4999	5079	5155	5251	5411	5567	5727	5883	6043	
4	5116	5196	5272	5368	5528	5684	5844	6000	6160	

Urethane arm caps are available in black, sable or dove.

54151ULG24 GLIDER, 24" SEAT, UPH ARM, URETHANE CAP, SHORT SKIRT, LOCKING MECHANISM

W: 31.5" D: 30" H: 42" SW: 24" SD: 19.5" SH: 18.5" AH: 24.75" WT: 71 lb COM: 4.25 yd WT CAP: 350 lb

ZONE	B/COM	C	D	E	F	G	H	I	J	GENERAL INFORMATION
1	4969	5054	5135	5237	5407	5573	5743	5908	6078	MATERIAL: - MOIS. BARR: Included
2	5092	5177	5258	5360	5530	5696	5866	6031	6201	
3	5214	5299	5380	5482	5652	5818	5988	6153	6323	
4	5337	5422	5503	5605	5775	5941	6111	6276	6446	

Urethane arm caps are available in black, sable or dove.

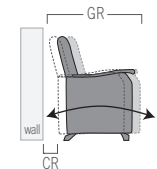

GR- Glider range from forward point to rear point is 41"

CR- Clearance required when placed against a wall is 7"

Specify:

- Product Number
- Wood Finish
- Urethane Cap Color
- Fabric Vendor, Pattern and Color

See pages 16 & 17 for material and finish options.

Versant Glider

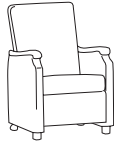

54251WG20 GLIDER, 20" SEAT, UPH ARM, WOOD CAP, LONG SKIRT

W: 27.5" D: 30" H: 42" SW: 20" SD: 19.5" SH: 18.5" AH: 24.75" WT: 63 lb COM: 4 yd WT CAP: 350 lb

ZONE	B/COM	C	D	E	F	G	H	I	J	GENERAL INFORMATION
1	4365	4445	4521	4617	4777	4933	5093	5249	5409	MATERIAL: Maple
2	4473	4553	4629	4725	4885	5041	5201	5357	5517	MOIS. BARR: Included
3	4580	4660	4736	4832	4992	5148	5308	5464	5624	
4	4688	4768	4844	4940	5100	5256	5416	5572	5732	

54251WG22 GLIDER, 22" SEAT, UPH ARM, WOOD CAP, LONG SKIRT

W: 29.5" D: 30" H: 42" SW: 22" SD: 19.5" SH: 18.5" AH: 24.75" WT: 66 lb COM: 4.25 yd WT CAP: 350 lb

ZONE	B/COM	C	D	E	F	G	H	I	J	GENERAL INFORMATION
1	4549	4634	4715	4817	4987	5153	5323	5488	5658	MATERIAL: Maple
2	4661	4746	4827	4929	5099	5265	5435	5600	5770	MOIS. BARR: Included
3	4773	4858	4939	5041	5211	5377	5547	5712	5882	
4	4885	4970	5051	5153	5323	5489	5659	5824	5994	

54251WG24 GLIDER, 24" SEAT, UPH ARM, WOOD CAP, LONG SKIRT

W: 31.5" D: 30" H: 42" SW: 24" SD: 19.5" SH: 18.5" AH: 24.75" WT: 69 lb COM: 4.5 yd WT CAP: 350 lb

ZONE	B/COM	C	D	E	F	G	H	I	J	GENERAL INFORMATION
1	4743	4833	4919	5027	5207	5382	5562	5738	5918	MATERIAL: Maple
2	4860	4950	5036	5144	5324	5499	5679	5855	6035	MOIS. BARR: Included
3	4977	5067	5153	5261	5441	5616	5796	5972	6152	
4	5093	5183	5269	5377	5557	5732	5912	6088	6268	



54251UG20 GLIDER, 20" SEAT, UPH ARM, URETHANE CAP, LONG SKIRT

W: 27.5" D: 30" H: 42" SW: 20" SD: 19.5" SH: 18.5" AH: 24.75" WT: 63 lb COM: 4 yd WT CAP: 350 lb

ZONE	B/COM	C	D	E	F	G	H	I	J	GENERAL INFORMATION
1	4365	4445	4521	4617	4777	4933	5093	5249	5409	MATERIAL: -
2	4473	4553	4629	4725	4885	5041	5201	5357	5517	MOIS. BARR: Included
3	4580	4660	4736	4832	4992	5148	5308	5464	5624	
4	4688	4768	4844	4940	5100	5256	5416	5572	5732	

Urethane arm caps are available in black, sable or dove.

54251UG22 GLIDER, 22" SEAT, UPH ARM, URETHANE CAP, LONG SKIRT

W: 29.5" D: 30" H: 42" SW: 22" SD: 19.5" SH: 18.5" AH: 24.75" WT: 66 lb COM: 4.25 yd WT CAP: 350 lb

ZONE	B/COM	C	D	E	F	G	H	I	J	GENERAL INFORMATION
1	4549	4634	4715	4817	4987	5153	5323	5488	5658	MATERIAL: -
2	4661	4746	4827	4929	5099	5265	5435	5600	5770	MOIS. BARR: Included
3	4773	4858	4939	5041	5211	5377	5547	5712	5882	
4	4885	4970	5051	5153	5323	5489	5659	5824	5994	

Urethane arm caps are available in black, sable or dove.

54251UG24 GLIDER, 24" SEAT, UPH ARM, URETHANE CAP, LONG SKIRT

W: 31.5" D: 30" H: 42" SW: 24" SD: 19.5" SH: 18.5" AH: 24.75" WT: 69 lb COM: 4.5 yd WT CAP: 350 lb

ZONE	B/COM	C	D	E	F	G	H	I	J	GENERAL INFORMATION
1	4743	4833	4919	5027	5207	5382	5562	5738	5918	MATERIAL: -
2	4860	4950	5036	5144	5324	5499	5679	5855	6035	MOIS. BARR: Included
3	4977	5067	5153	5261	5441	5616	5796	5972	6152	
4	5093	5183	5269	5377	5557	5732	5912	6088	6268	

Urethane arm caps are available in black, sable or dove.

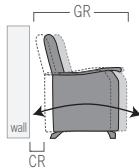

GR- Glider range from forward point to rear point is 41"

CR- Clearance required when placed against a wall is 7"

Specify:

- Product Number
- Wood Finish
- Urethane Cap Color
- Fabric Vendor, Pattern and Color

See pages 16 & 17 for material and finish options.

Versant Glider



54251WLG20 GLIDER, 20" SEAT, UPH ARM, WOOD CAP, LONG SKIRT, LOCKING MECHANISM

W: 27.5" D: 30" H: 42" SW: 20" SD: 19.5" SH: 18.5" AH: 24.75" WT: 65 lb COM: 4 yd WT CAP: 350 lb

ZONE	B/COM	C	D	E	F	G	H	I	J	GENERAL INFORMATION
1	4640	4720	4796	4892	5052	5208	5368	5524	5684	MATERIAL: Maple
2	4754	4834	4910	5006	5166	5322	5482	5638	5798	MOIS. BARR: Included
3	4869	4949	5025	5121	5281	5437	5597	5753	5913	
4	4983	5063	5139	5235	5395	5551	5711	5867	6027	

54251WLG22 GLIDER, 22" SEAT, UPH ARM, WOOD CAP, LONG SKIRT, LOCKING MECHANISM

W: 29.5" D: 30" H: 42" SW: 22" SD: 19.5" SH: 18.5" AH: 24.75" WT: 68 lb COM: 4.25 yd WT CAP: 350 lb

ZONE	B/COM	C	D	E	F	G	H	I	J	GENERAL INFORMATION
1	4836	4921	5002	5104	5274	5440	5610	5775	5945	MATERIAL: Maple
2	4955	5040	5121	5223	5393	5559	5729	5894	6064	MOIS. BARR: Included
3	5074	5159	5240	5342	5512	5678	5848	6013	6183	
4	5194	5279	5360	5462	5632	5798	5968	6133	6303	

54251WLG24 GLIDER, 24" SEAT, UPH ARM, WOOD CAP, LONG SKIRT, LOCKING MECHANISM

W: 31.5" D: 30" H: 42" SW: 24" SD: 19.5" SH: 18.5" AH: 24.75" WT: 71 lb COM: 4.5 yd WT CAP: 350 lb

ZONE	B/COM	C	D	E	F	G	H	I	J	GENERAL INFORMATION
1	5044	5134	5220	5328	5508	5683	5863	6039	6219	MATERIAL: Maple
2	5168	5258	5344	5452	5632	5807	5987	6163	6343	MOIS. BARR: Included
3	5293	5383	5469	5577	5757	5932	6112	6288	6468	
4	5417	5507	5593	5701	5881	6056	6236	6412	6592	



54251ULG20 GLIDER, 20" SEAT, UPH ARM, URETHANE CAP, LONG SKIRT, LOCKING MECHANISM

W: 27.5" D: 30" H: 42" SW: 20" SD: 19.5" SH: 18.5" AH: 24.75" WT: 65 lb COM: 4 yd WT CAP: 350 lb

ZONE	B/COM	C	D	E	F	G	H	I	J	GENERAL INFORMATION
1	4640	4720	4796	4892	5052	5208	5368	5524	5684	MATERIAL: -
2	4754	4834	4910	5006	5166	5322	5482	5638	5798	MOIS. BARR: Included
3	4869	4949	5025	5121	5281	5437	5597	5753	5913	
4	4983	5063	5139	5235	5395	5551	5711	5867	6027	

Urethane arm caps are available in black, sable or dove.

54251ULG22 GLIDER, 22" SEAT, UPH ARM, URETHANE CAP, LONG SKIRT, LOCKING MECHANISM

W: 29.5" D: 30" H: 42" SW: 22" SD: 19.5" SH: 18.5" AH: 24.75" WT: 68 lb COM: 4.25 yd WT CAP: 350 lb

ZONE	B/COM	C	D	E	F	G	H	I	J	GENERAL INFORMATION
1	4836	4921	5002	5104	5274	5440	5610	5775	5945	MATERIAL: -
2	4955	5040	5121	5223	5393	5559	5729	5894	6064	MOIS. BARR: Included
3	5074	5159	5240	5342	5512	5678	5848	6013	6183	
4	5194	5279	5360	5462	5632	5798	5968	6133	6303	

Urethane arm caps are available in black, sable or dove.

54251ULG24 GLIDER, 24" SEAT, UPH ARM, URETHANE CAP, LONG SKIRT, LOCKING MECHANISM

W: 31.5" D: 30" H: 42" SW: 24" SD: 19.5" SH: 18.5" AH: 24.75" WT: 71 lb COM: 4.5 yd WT CAP: 350 lb

ZONE	B/COM	C	D	E	F	G	H	I	J	GENERAL INFORMATION
1	5044	5134	5220	5328	5508	5683	5863	6039	6219	MATERIAL: -
2	5168	5258	5344	5452	5632	5807	5987	6163	6343	MOIS. BARR: Included
3	5293	5383	5469	5577	5757	5932	6112	6288	6468	
4	5417	5507	5593	5701	5881	6056	6236	6412	6592	

Urethane arm caps are available in black, sable or dove.

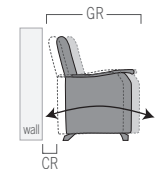

GR- Glider range from forward point to rear point is 41"

CR- Clearance required when placed against a wall is 7"

Specify:

- Product Number
- Wood Finish
- Urethane Cap Color
- Fabric Vendor, Pattern and Color

See pages 16 & 17 for material and finish options.

Versant Sleep Chairs



54841W24 SLEEP CHAIR, 24" SEAT, WOOD CAP

W: 32.5" D: 39" H: 31.25" SW: 24" SD: 21.75" SH: 17.5" AH: 24.5" WT: 130 lb COM: 6.75 yd WT CAP: 600 lb

ZONE	B/COM	C	D	E	F	G	H	I	J	GENERAL INFORMATION
1	7523	7658	7786	7948	8218	8482	8752	9015	9285	MATERIAL: Maple
2	7708	7843	7971	8133	8403	8667	8937	9200	9470	MOIS. BARR: Included
3	7894	8029	8157	8319	8589	8853	9123	9386	9656	
4	8079	8214	8342	8504	8774	9038	9308	9571	9841	

Versant sleep chairs are wallsavers designed with 0" clearance required to open the sleep surface if placed against a wall. Casters are standard. Glides are available at no upcharge.

54841W30 SLEEP CHAIR, 30" SEAT, WOOD CAP

W: 38.5" D: 39" H: 31.25" SW: 30" SD: 21.75" SH: 17.5" AH: 24.5" WT: 148 lb COM: 9.5 yd WT CAP: 600 lb

ZONE	B/COM	C	D	E	F	G	H	I	J	GENERAL INFORMATION
1	8133	8323	8504	8732	9112	9482	9862	10233	10613	MATERIAL: Maple
2	8333	8523	8704	8932	9312	9682	10062	10433	10813	MOIS. BARR: Included
3	8532	8722	8903	9131	9511	9881	10261	10632	11012	
4	8732	8922	9103	9331	9711	10081	10461	10832	11212	

Versant sleep chairs are wallsavers designed with 0" clearance required to open the sleep surface if placed against a wall. Casters are standard. Glides are available at no upcharge.

54841W48 SLEEP CHAIR, 48" SEAT, WOOD CAP

W: 56.5" D: 39" H: 31.25" SW: 48" SD: 21.75" SH: 17.5" AH: 24.5" WT: 202 lb COM: 10 yd WT CAP: 600 lb

ZONE	B/COM	C	D	E	F	G	H	I	J	GENERAL INFORMATION
1	9304	9504	9694	9934	10334	10724	11124	11514	11914	MATERIAL: Maple
2	9533	9733	9923	10163	10563	10953	11353	11743	12143	MOIS. BARR: Included
3	9761	9961	10151	10391	10791	11181	11581	11971	12371	
4	9990	10190	10380	10620	11020	11410	11810	12200	12600	

Versant sleep chairs are wallsavers designed with 0" clearance required to open the sleep surface if placed against a wall. Casters are standard. Glides are available at no upcharge.



54841U24 SLEEP CHAIR, 24" SEAT, URETHANE CAP

W: 32.5" D: 39" H: 31.25" SW: 24" SD: 21.75" SH: 17.5" AH: 24.5" WT: 133 lb COM: 6.75 yd WT CAP: 600 lb

ZONE	B/COM	C	D	E	F	G	H	I	J	GENERAL INFORMATION
1	7523	7658	7786	7948	8218	8482	8752	9015	9285	MATERIAL: -
2	7708	7843	7971	8133	8403	8667	8937	9200	9470	MOIS. BARR: Included
3	7894	8029	8157	8319	8589	8853	9123	9386	9656	
4	8079	8214	8342	8504	8774	9038	9308	9571	9841	

Versant sleep chairs are wallsavers designed with 0" clearance required to open the sleep surface if placed against a wall. Casters are standard. Glides are available at no upcharge. Urethane arm caps are available in black, sable or dove.

54841U30 SLEEP CHAIR, 30" SEAT, URETHANE CAP

W: 38.5" D: 39" H: 31.25" SW: 30" SD: 21.75" SH: 17.5" AH: 24.5" WT: 151 lb COM: 9.5 yd WT CAP: 600 lb

ZONE	B/COM	C	D	E	F	G	H	I	J	GENERAL INFORMATION
1	8133	8323	8504	8732	9112	9482	9862	10233	10613	MATERIAL: -
2	8333	8523	8704	8932	9312	9682	10062	10433	10813	MOIS. BARR: Included
3	8532	8722	8903	9131	9511	9881	10261	10632	11012	
4	8732	8922	9103	9331	9711	10081	10461	10832	11212	

Versant sleep chairs are wallsavers designed with 0" clearance required to open the sleep surface if placed against a wall. Casters are standard. Glides are available at no upcharge. Urethane arm caps are available in black, sable or dove.

54841U48 SLEEP CHAIR, 48" SEAT, URETHANE CAP

W: 56.5" D: 39" H: 31.25" SW: 48" SD: 21.75" SH: 17.5" AH: 24.5" WT: 205 lb COM: 10 yd WT CAP: 600 lb

ZONE	B/COM	C	D	E	F	G	H	I	J	GENERAL INFORMATION
1	9304	9504	9694	9934	10334	10724	11124	11514	11914	MATERIAL: -
2	9533	9733	9923	10163	10563	10953	11353	11743	12143	MOIS. BARR: Included
3	9761	9961	10151	10391	10791	11181	11581	11971	12371	
4	9990	10190	10380	10620	11020	11410	11810	12200	12600	

Versant sleep chairs are wallsavers designed with 0" clearance required to open the sleep surface if placed against a wall. Casters are standard. Glides are available at no upcharge. Urethane arm caps are available in black, sable or dove.

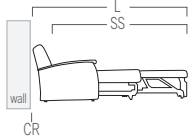

SS- Sleep surface 77"

CR- Clearance required to open sleep surface when placed against a wall is 0"

L- Overall length is 92"

Specify:

- Product Number
- Wood Finish
- Urethane Cap Color
- Fabric Vendor, Pattern and Color

See pages 16 & 17 for material and finish options.

Versant Sleep Chairs



54841WM24 SLEEP CHAIR, 24" SEAT, MODERN WOOD CAP

W: 32.5" D: 39" H: 31.25" SW: 24" SD: 21.75" SH: 17.5" AH: 24.5" WT: 130 lb COM: 6.75 yd WT CAP: 600 lb

ZONE	B/COM	C	D	E	F	G	H	I	J	GENERAL INFORMATION
1	7523	7658	7786	7948	8218	8482	8752	9015	9285	MATERIAL: Maple
2	7708	7843	7971	8133	8403	8667	8937	9200	9470	MOIS. BARR: Included
3	7894	8029	8157	8319	8589	8853	9123	9386	9656	
4	8079	8214	8342	8504	8774	9038	9308	9571	9841	

Versant sleep chairs are wallsavers designed with 0" clearance required to open the sleep surface if placed against a wall. Casters are standard. Glides are available at no upcharge.

54841WM30 SLEEP CHAIR, 30" SEAT, MODERN WOOD CAP

W: 38.5" D: 39" H: 31.25" SW: 30" SD: 21.75" SH: 17.5" AH: 24.5" WT: 148 lb COM: 9.5 yd WT CAP: 600 lb

ZONE	B/COM	C	D	E	F	G	H	I	J	GENERAL INFORMATION
1	8133	8323	8504	8732	9112	9482	9862	10233	10613	MATERIAL: Maple
2	8333	8523	8704	8932	9312	9682	10062	10433	10813	MOIS. BARR: Included
3	8532	8722	8903	9131	9511	9881	10261	10632	11012	
4	8732	8922	9103	9331	9711	10081	10461	10832	11212	

Versant sleep chairs are wallsavers designed with 0" clearance required to open the sleep surface if placed against a wall. Casters are standard. Glides are available at no upcharge.

54841WM48 SLEEP CHAIR, 48" SEAT, MODERN WOOD CAP

W: 56.5" D: 39" H: 31.25" SW: 48" SD: 21.75" SH: 17.5" AH: 24.5" WT: 202 lb COM: 10 yd WT CAP: 600 lb

ZONE	B/COM	C	D	E	F	G	H	I	J	GENERAL INFORMATION
1	9304	9504	9694	9934	10334	10724	11124	11514	11914	MATERIAL: Maple
2	9533	9733	9923	10163	10563	10953	11353	11743	12143	MOIS. BARR: Included
3	9761	9961	10151	10391	10791	11181	11581	11971	12371	
4	9990	10190	10380	10620	11020	11410	11810	12200	12600	

Versant sleep chairs are wallsavers designed with 0" clearance required to open the sleep surface if placed against a wall. Casters are standard. Glides are available at no upcharge.



54841UM24 SLEEP CHAIR, 24" SEAT, MODERN URETHANE CAP

W: 32.5" D: 39" H: 31.25" SW: 24" SD: 21.75" SH: 17.5" AH: 24.5" WT: 130 lb COM: 6.75 yd WT CAP: 600 lb

ZONE	B/COM	C	D	E	F	G	H	I	J	GENERAL INFORMATION
1	7523	7658	7786	7948	8218	8482	8752	9015	9285	MATERIAL: -
2	7708	7843	7971	8133	8403	8667	8937	9200	9470	MOIS. BARR: Included
3	7894	8029	8157	8319	8589	8853	9123	9386	9656	
4	8079	8214	8342	8504	8774	9038	9308	9571	9841	

Versant sleep chairs are wallsavers designed with 0" clearance required to open the sleep surface if placed against a wall. Casters are standard. Glides are available at no upcharge. Urethane arm caps are available in black, sable or dove.

54841UM30 SLEEP CHAIR, 30" SEAT, MODERN URETHANE CAP

W: 38.5" D: 39" H: 31.25" SW: 30" SD: 21.75" SH: 17.5" AH: 24.5" WT: 151 lb COM: 9.5 yd WT CAP: 600 lb

ZONE	B/COM	C	D	E	F	G	H	I	J	GENERAL INFORMATION
1	8133	8323	8504	8732	9112	9482	9862	10233	10613	MATERIAL: -
2	8333	8523	8704	8932	9312	9682	10062	10433	10813	MOIS. BARR: Included
3	8532	8722	8903	9131	9511	9881	10261	10632	11012	
4	8732	8922	9103	9331	9711	10081	10461	10832	11212	

Versant sleep chairs are wallsavers designed with 0" clearance required to open the sleep surface if placed against a wall. Casters are standard. Glides are available at no upcharge. Urethane arm caps are available in black, sable or dove.

54841UM48 SLEEP CHAIR, 48" SEAT, MODERN URETHANE CAP

W: 56.5" D: 39" H: 31.25" SW: 48" SD: 21.75" SH: 17.5" AH: 24.5" WT: 205 lb COM: 10 yd WT CAP: 600 lb

ZONE	B/COM	C	D	E	F	G	H	I	J	GENERAL INFORMATION
1	9304	9504	9694	9934	10334	10724	11124	11514	11914	MATERIAL: -
2	9533	9733	9923	10163	10563	10953	11353	11743	12143	MOIS. BARR: Included
3	9761	9961	10151	10391	10791	11181	11581	11971	12371	
4	9990	10190	10380	10620	11020	11410	11810	12200	12600	

Versant sleep chairs are wallsavers designed with 0" clearance required to open the sleep surface if placed against a wall. Casters are standard. Glides are available at no upcharge. Urethane arm caps are available in black, sable or dove.

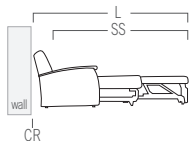

SS- Sleep surface 77"

CR- Clearance required to open sleep surface when placed against a wall is 0"

L- Overall length is 92"

Specify:

- Product Number
- Wood Finish
- Urethane Cap Color
- Fabric Vendor, Pattern and Color

See pages 16 & 17 for material and finish options.



7324004 CHAIR, WOOD ARM, LOW BACK

W: 24" D: 25.5" H: 33" SW: 20" SD: 18.75" SH: 18" AH: 25.75" WT: 28 lb COM: 1.5 yd WT CAP: 300 lb

ZONE	B/COM	C	D	E	F	G	H	I	J	GENERAL INFORMATION
1	1989	2019	2048	2084	2144	2202	2262	2321	2381	MATERIAL: Beech
2	2038	2068	2097	2133	2193	2251	2311	2370	2430	MOIS. BARR: \$8
3	2087	2117	2146	2182	2242	2300	2360	2419	2479	
4	2136	2166	2195	2231	2291	2349	2409	2468	2528	



7324005 CHAIR, WOOD ARM, MID BACK

W: 24" D: 25.5" H: 39" SW: 20" SD: 18.75" SH: 18" AH: 25.75" WT: 31 lb COM: 1.5 yd WT CAP: 300 lb

ZONE	B/COM	C	D	E	F	G	H	I	J	GENERAL INFORMATION
1	2082	2112	2141	2177	2237	2295	2355	2414	2474	MATERIAL: Beech
2	2133	2163	2192	2228	2288	2346	2406	2465	2525	MOIS. BARR: \$8
3	2185	2215	2244	2280	2340	2398	2458	2517	2577	
4	2236	2266	2295	2331	2391	2449	2509	2568	2628	

Accessories

URETHANE ARM CAPS

\$215 2 Arms Available in black, sable or dove.

Specify:

- Product Number
- Wood Finish
- Urethane Finish
- Fabric Vendor, Pattern and Color

See pages 16 & 17 for material and finish options.

Wedgewood Patient and Motion



7324006 PATIENT CHAIR, WOOD ARM, HIGH BACK

W: 24"	D: 25.5"	H: 43"	SW: 20"	SD: 18.75"	SH: 18"	AH: 25.75"	WT: 33 lb	COM: 2.2 yd	WT CAP: 300 lb	
ZONE	B/COM	C	D	E	F	G	H	I	J	GENERAL INFORMATION
1	2197	2241	2283	2336	2424	2510	2598	2683	2771	MATERIAL: Beech
2	2251	2295	2337	2390	2478	2564	2652	2737	2825	MOIS. BARR: \$8
3	2305	2349	2391	2444	2532	2618	2706	2791	2879	
4	2359	2403	2445	2498	2586	2672	2760	2845	2933	



7324009 MOTION CHAIR, WOOD ARM, MID BACK

W: 25"	D: 26.5"	H: 39"	SW: 20.25"	SD: 18.75"	SH: 18"	AH: 25.75"	WT: 50 lb	COM: 2.2 yd	WT CAP: 300 lb	
ZONE	B/COM	C	D	E	F	G	H	I	J	GENERAL INFORMATION
1	2957	3001	3043	3096	3184	3270	3358	3443	3531	MATERIAL: Beech
2	3030	3074	3116	3169	3257	3343	3431	3516	3604	MOIS. BARR: \$6
3	3103	3147	3189	3242	3330	3416	3504	3589	3677	
4	3176	3220	3262	3315	3403	3489	3577	3662	3750	

Leg extensions are not available on motion chairs. Casters (7144002) are available on rear legs only. Specify locking or non-locking. Non-skid glides are provided on the front legs



7324010 MOTION PATIENT CHAIR, WOOD ARM, HIGH BACK

W: 25"	D: 26.5"	H: 45"	SW: 20.25"	SD: 18.75"	SH: 18"	AH: 25.75"	WT: 52 lb	COM: 2.2 yd	WT CAP: 300 lb	
ZONE	B/COM	C	D	E	F	G	H	I	J	GENERAL INFORMATION
1	3053	3097	3139	3192	3280	3366	3454	3539	3627	MATERIAL: Beech
2	3128	3172	3214	3267	3355	3441	3529	3614	3702	MOIS. BARR: \$6
3	3204	3248	3290	3343	3431	3517	3605	3690	3778	
4	3279	3323	3365	3418	3506	3592	3680	3765	3853	

Leg extensions are not available on motion chairs. Casters (7144002) are available on rear legs only. Specify locking or non-locking. Non-skid glides are provided on the front legs



7024007 OTTOMAN, 10" HEIGHT

W: 19"	D: 16"	H: 10"	SW: -	SD: -	SH: -	AH: -	WT: 9 lb	COM: .4 yd	WT CAP: 300 lb	
ZONE	B/COM	C	D	E	F	G	H	I	J	GENERAL INFORMATION
1	963	971	979	989	1005	1020	1036	1052	1068	MATERIAL: Beech
2	987	995	1003	1013	1029	1044	1060	1076	1092	MOIS. BARR: \$5
3	1011	1019	1027	1037	1053	1068	1084	1100	1116	
4	1035	1043	1051	1061	1077	1092	1108	1124	1140	



7024008 OTTOMAN, 18" HEIGHT

W: 19"	D: 16.75"	H: 18"	SW: -	SD: -	SH: -	AH: -	WT: 15 lb	COM: .4 yd	WT CAP: 300 lb	
ZONE	B/COM	C	D	E	F	G	H	I	J	GENERAL INFORMATION
1	963	971	979	989	1005	1020	1036	1052	1068	MATERIAL: Beech
2	987	995	1003	1013	1029	1044	1060	1076	1092	MOIS. BARR: \$5
3	1011	1019	1027	1037	1053	1068	1084	1100	1116	
4	1035	1043	1051	1061	1077	1092	1108	1124	1140	

Cannot be used with motion chairs.

Accessories

URETHANE ARM CAPS

\$226 2 Arms Available in black, sable or dove.

Specify:

- Product Number
- Wood Finish
- Urethane Cap Color
- Fabric Vendor, Pattern and Color

See pages 16 & 17 for material and finish options.

Wedgewood Bariatric



7324058 BARIATRIC CHAIR, 20" SEAT, WOOD ARM

W: 24" D: 24.75" H: 35" SW: 20" SD: 18.75" SH: 18" AH: 25.75" WT: 30 lb COM: 1.5 yd WT CAP: 750 lb

ZONE	B/COM	C	D	E	F	G	H	I	J	GENERAL INFORMATION
1	2082	2112	2141	2177	2237	2295	2355	2414	2474	MATERIAL: Beech MOIS. BARR: \$8
2	2133	2163	2192	2228	2288	2346	2406	2465	2525	
3	2185	2215	2244	2280	2340	2398	2458	2517	2577	
4	2236	2266	2295	2331	2391	2449	2509	2568	2628	

7324054 BARIATRIC CHAIR, 25" SEAT, WOOD ARM

W: 29" D: 24.75" H: 35" SW: 25" SD: 18.75" SH: 18" AH: 25.75" WT: 36 lb COM: 2.3 yd WT CAP: 750 lb

ZONE	B/COM	C	D	E	F	G	H	I	J	GENERAL INFORMATION
1	2663	2709	2753	2808	2900	2989	3081	3171	3263	MATERIAL: Beech MOIS. BARR: \$16
2	2729	2775	2819	2874	2966	3055	3147	3237	3329	
3	2794	2840	2884	2939	3031	3120	3212	3302	3394	
4	2860	2906	2950	3005	3097	3186	3278	3368	3460	



7324055 BARIATRIC CHAIR, 30" SEAT, WOOD ARM

W: 34" D: 24.75" H: 35" SW: 30" SD: 18.75" SH: 18" AH: 25.75" WT: 40 lb COM: 2.3 yd WT CAP: 750 lb

ZONE	B/COM	C	D	E	F	G	H	I	J	GENERAL INFORMATION
1	2813	2859	2903	2958	3050	3139	3231	3321	3413	MATERIAL: Beech MOIS. BARR: \$17
2	2882	2928	2972	3027	3119	3208	3300	3390	3482	
3	2952	2998	3042	3097	3189	3278	3370	3460	3552	
4	3021	3067	3111	3166	3258	3347	3439	3529	3621	

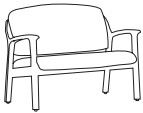

7324056 BARIATRIC LOVESEAT, 40" SEAT, WOOD ARM

W: 44" D: 24.75" H: 35" SW: 40" SD: 18.75" SH: 18" AH: 25.75" WT: 46 lb COM: 2.7 yd WT CAP: 750 lb

ZONE	B/COM	C	D	E	F	G	H	I	J	GENERAL INFORMATION
1	2966	3020	3072	3136	3244	3350	3458	3563	3671	MATERIAL: Beech MOIS. BARR: \$17
2	3039	3093	3145	3209	3317	3423	3531	3636	3744	
3	3112	3166	3218	3282	3390	3496	3604	3709	3817	
4	3185	3239	3291	3355	3463	3569	3677	3782	3890	



7324063 BARIATRIC CHAIR, 25" SEAT, WOOD ARM, MID-BACK

W: 29" D: 24.75" H: 39" SW: 25" SD: 18.75" SH: 18" AH: 25.75" WT: 39 lb COM: 2.5 yd WT CAP: 750 lb

ZONE	B/COM	C	D	E	F	G	H	I	J	GENERAL INFORMATION
1	2767	2817	2865	2925	3025	3122	3222	3320	3420	MATERIAL: Beech MOIS. BARR: \$17
2	2835	2885	2933	2993	3093	3190	3290	3388	3488	
3	2903	2953	3001	3061	3161	3258	3358	3456	3556	
4	2972	3022	3070	3130	3230	3327	3427	3525	3625	

7324064 BARIATRIC CHAIR, 30" SEAT, WOOD ARM, MID-BACK

W: 34" D: 24.75" H: 39" SW: 30" SD: 18.75" SH: 18" AH: 25.75" WT: 45 lb COM: 2.5 yd WT CAP: 750 lb

ZONE	B/COM	C	D	E	F	G	H	I	J	GENERAL INFORMATION
1	2916	2966	3014	3074	3174	3271	3371	3469	3569	MATERIAL: Beech MOIS. BARR: \$17
2	2988	3038	3086	3146	3246	3343	3443	3541	3641	
3	3060	3110	3158	3218	3318	3415	3515	3613	3713	
4	3132	3182	3230	3290	3390	3487	3587	3685	3785	

Specify:

- Product Number
- Wood Finish
- Urethane Cap Color
- Fabric Vendor, Pattern and Color

See pages 16 & 17 for material and finish options.

Wedgewood Bariatric



7324065 BARIATRIC LOVESEAT, 40" SEAT, WOOD ARM, MID-BACK

W: 44" D: 24.75" H: 39" SW: 40" SD: 18.75" SH: 18" AH: 25.75" WT: 51 lb COM: 2.7 yd WT CAP: 750 lb

ZONE	B/COM	C	D	E	F	G	H	I	J	GENERAL INFORMATION
1	3064	3118	3170	3234	3342	3448	3556	3661	3769	MATERIAL: Beech
2	3140	3194	3246	3310	3418	3524	3632	3737	3845	MOIS. BARR: \$17
3	3215	3269	3321	3385	3493	3599	3707	3812	3920	
4	3291	3345	3397	3461	3569	3675	3783	3888	3996	

Accessories



7070009 LEG EXTENSIONS (SET OF FOUR)

\$454 per chair WT: 2 lb

Price includes glides. Adjusts height from 1" to 5". Standard color is Champagne Bronze. Leg extensions are not available on motion chairs, loveseats or sofas.



7144001 REAR LOCKING CASTERS, FRONT NON-LOCKING CARPET SURFACE (SET OF FOUR)

STEM SIZE: 50 mm CASTER SIZE: 2"
LOAD CAP: 110 lb p/caster WT: 1 lb

\$135

Includes two front non-locking casters and two rear locking casters.



7144002 CASTERS, CARPET SURFACE (SET OF TWO)

STEM SIZE: 50 mm CASTER SIZE: 2"
LOAD CAP: 110 lb p/caster WT: 0.5 lb

\$108

Specify locking or non-locking for front or rear legs when ordering.



7144003 REAR LOCKING CASTERS, FRONT NON-LOCKING, HARD SURFACE (SET OF FOUR)

STEM SIZE: 50 mm CASTER SIZE: 2"
LOAD CAP: 110 lb p/caster WT: 1 lb

\$135

Includes two front non-locking casters and two rear locking casters.



7144004 CASTERS, HARD SURFACE (SET OF TWO)

STEM SIZE: 50 mm CASTER SIZE: 2"
LOAD CAP: 110 lb p/caster WT: 0.5 lb

\$108

Specify locking or non-locking for front or rear legs when ordering.



7144100 TIP BACK CASTERS (SET OF TWO)

\$122 per chair WT: 0.5 lb

URETHANE ARM CAPS

\$226 2 Arms Available in black, sable or dove.

Specify:

- Product Number
- Wood Finish
- Urethane Cap Color
- Fabric Vendor, Pattern and Color

See pages 16 & 17 for material and finish options.

Tables

4700 Series Occasional Tables



4700-01 END TABLE, 22H 24W 24D

W: 24" D: 24" H: 22" WT: 57 lb

Zone	1	2	3	4
	1720	1763	1806	1849

GENERAL INFORMATION

TOP MATERIAL: Thermoform or Solid Surface
BASE MATERIAL: Silver Metal



4700-03 COFFEE TABLE, 17H 42W 24D

W: 42" D: 24" H: 17" WT: 76 lb

Zone	1	2	3	4
	2101	2154	2206	2259

GENERAL INFORMATION

TOP MATERIAL: Thermoform or Solid Surface
BASE MATERIAL: Silver Metal



4700-13 COFFEE TABLE WITH SHELF, 17H 42W 24D

W: 42" D: 24" H: 17" WT: 100 lb

Zone	1	2	3	4
	2819	2889	2960	3030

GENERAL INFORMATION

TOP MATERIAL: Thermoform or Solid Surface
BASE MATERIAL: Silver Metal



4700-05 CONSOLE TABLE, 29H 48W 18D

W: 48" D: 18" H: 29" WT: 75 lb

Zone	1	2	3	4
	2194	2249	2304	2359

GENERAL INFORMATION

TOP MATERIAL: Thermoform or Solid Surface
BASE MATERIAL: Silver Metal



4700-15 CONSOLE TABLE WITH SHELF, 29H 48W 18D

W: 48" D: 18" H: 29" WT: 83 lb

Zone	1	2	3	4
	2723	2791	2859	2927

GENERAL INFORMATION

TOP MATERIAL: Thermoform or Solid Surface
BASE MATERIAL: Silver Metal

Table Top Options

SOLID SURFACE

\$679 Table

\$1086 Table w/Shelf

Specify solid surface color.

Specify:

- Product Number
- Thermoform Finish
- Solid Surface Name and Number

See pages 16 & 17 for material and finish options.

Drum and Cube Occasional Tables

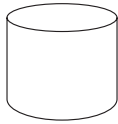

DRUM

Product Number	Dimensions	Shape	Weight	Zone 1	Zone 2	Zone 3	Zone 4	2" Aluminum Laminate Kickplate Upcharge
0118D16H	18" DIA x 16" H	Round	34 lb	1172	1201	1231	1260	74
0118D18H	18" DIA x 18" H	Round	35 lb	1172	1201	1231	1260	74
0118D20H	18" DIA x 20" H	Round	36 lb	1172	1201	1231	1260	74
0118D22H	18" DIA x 22" H	Round	37 lb	1172	1201	1231	1260	74
0124D16H	24" DIA x 16" H	Round	48 lb	1237	1268	1299	1330	74
0124D18H	24" DIA x 18" H	Round	49 lb	1237	1268	1299	1330	74
0124D20H	24" DIA x 20" H	Round	50 lb	1237	1268	1299	1330	74
0124D22H	24" DIA x 22" H	Round	51 lb	1237	1268	1299	1330	74
0130D16H	30" DIA x 16" H	Round	62 lb	1554	1593	1632	1671	74
0130D18H	30" DIA x 18" H	Round	63 lb	1554	1593	1632	1671	74
0130D20H	30" DIA x 20" H	Round	64 lb	1554	1593	1632	1671	74
0130D22H	30" DIA x 22" H	Round	65 lb	1554	1593	1632	1671	74
0136D16H	36" DIA x 16" H	Round	77 lb	1760	1804	1848	1892	74
0136D18H	36" DIA x 18" H	Round	78 lb	1760	1804	1848	1892	74
0136D20H	36" DIA x 20" H	Round	79 lb	1760	1804	1848	1892	74
0136D22H	36" DIA x 22" H	Round	80 lb	1760	1804	1848	1892	74
0142D16H	42" DIA x 16" H	Round	94 lb	1953	2002	2051	2099	74
0142D18H	42" DIA x 18" H	Round	95 lb	1953	2002	2051	2099	74
0142D20H	42" DIA x 20" H	Round	96 lb	1953	2002	2051	2099	74
0142D22H	42" DIA x 22" H	Round	97 lb	1953	2002	2051	2099	74

Laminate with optional aluminum kickplate. Specify laminate and kickplate option if desired.

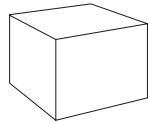

CUBE

Product Number	Dimensions	Shape	Weight	Zone 1	Zone 2	Zone 3	Zone 4	2" Aluminum Laminate Kickplate Upcharge
0118SQ16H	16" H x 18" W x 18" L	Square	37 lb	889	911	933	956	74
0118SQ18H	18" H x 18" W x 18" L	Square	39 lb	889	911	933	956	74
0118SQ20H	20" H x 18" W x 18" L	Square	41 lb	889	911	933	956	74
0118SQ22H	22" H x 18" W x 18" L	Square	43 lb	889	911	933	956	74
0124SQ16H	16" H x 24" W x 24" L	Square	56 lb	938	961	985	1008	74
0124SQ18H	18" H x 24" W x 24" L	Square	58 lb	938	961	985	1008	74
0124SQ20H	20" H x 24" W x 24" L	Square	60 lb	938	961	985	1008	74
0124SQ22H	22" H x 24" W x 24" L	Square	62 lb	938	961	985	1008	74
0130SQ16H	16" H x 30" W x 30" L	Square	69 lb	1177	1206	1236	1265	74
0130SQ18H	18" H x 30" W x 30" L	Square	71 lb	1177	1206	1236	1265	74
0130SQ20H	20" H x 30" W x 30" L	Square	73 lb	1177	1206	1236	1265	74
0130SQ22H	22" H x 30" W x 30" L	Square	75 lb	1177	1206	1236	1265	74
0136SQ16H	16" H x 36" W x 36" L	Square	106 lb	1369	1403	1437	1472	74
0136SQ18H	18" H x 36" W x 36" L	Square	108 lb	1369	1403	1437	1472	74
0136SQ20H	20" H x 36" W x 36" L	Square	110 lb	1369	1403	1437	1472	74
0136SQ22H	22" H x 36" W x 36" L	Square	112 lb	1369	1403	1437	1472	74

Laminate with optional aluminum kickplate. Specify laminate and kickplate option if desired.

Accessories

Specify:

- Product Number
- Laminate Vendor, Pattern and Finish
- Kickplate Option
- Power Option and Color
- Cord Opening Option



COVC2P2U-B POWER, CLAMP MOUNTED

Black, 2 Power, 2 USB

COVC2P2U-S POWER, CLAMP MOUNTED

Silver Pearl, 2 Power, 2 USB

COVC2P2U-W POWER, CLAMP MOUNTED

Gloss White, 2 Power, 2 USB

\$629 All Colors

Cord is 108" long.



COVS2P2U-B POWER, SCREW MOUNTED

Black, 2 Power, 2 USB

COVS2P2U-S POWER, SCREW MOUNTED

Silver Pearl, 2 Power, 2 USB

COVS2P2U-W POWER, SCREW MOUNTED

Gloss White, 2 Power, 2 USB

\$629 All Colors

Cord is 108" long.

Fuse Occasional Tables

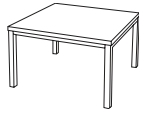

FUSE

Product Number	Dimensions	Shape	Weight	Zone 1	Zone 2	Zone 3	Zone 4
882424SQFVST118	18" H x 24" W x 24" L	Square	54 lb	1281	1313	1345	1377
883030SQFVST118	18" H x 30" W x 30" L	Square	64 lb	1440	1476	1512	1548
882448REFVST118	18" H x 48" W x 24" L	Rectangle	72 lb	1518	1556	1594	1632

Laminate top with metal base. Specify laminate, edge style and metal finish when ordering. Table ships unassembled.

Edge Style Options



2MM BIO EDGE

Available in 7 colors to match metal finishes.



SELF EDGE

Matches top laminate.



2MM PVC WOOD GRAIN EDGE

Available in 9 wood grain colors to match standard laminates.

Accessories



HARD CASTERS (FOR SOFT SURFACES)

\$133 per table

All bases are standard with floor-leveling glides. Casters are available on select models. See notes below product chart for availability.



VSC SEAM CONNECTOR

W: 2" H: 5" WT: .5 lb

\$142

To join and level tops. Includes 2 connectors, 4 thumb screws, 4 counter sunk threaded metal inserts. Standard in black.



SOFT CASTERS (FOR HARD SURFACES)

\$289 per table

All bases are standard with floor-leveling glides. Casters are available on select models. See notes below product chart for availability.

Specify:

- Product Number
- Finish
- Edge Style
- Laminate Vendor, Pattern and Finish

Trumpet and Disc Occasional Tables



TRUMPET ROUND

Product Number	Dimensions	Weight	Zone 1	Zone 2	Zone 3	Zone 4
8724DTR18	OCCASIONAL TABLE, 18" H x 24" L	61 lb	973	997	1022	1046
8730DTR18	OCCASIONAL TABLE, 18" H x 30" L	71 lb	1128	1156	1184	1213
8736DTR18	OCCASIONAL TABLE, 18" H x 36" L	82 lb	1275	1307	1339	1371
8742DTR18	OCCASIONAL TABLE, 18" H x 42" L	96 lb	1696	1738	1781	1823

Round laminate top with metal base. Specify laminate, edge style and metal finish when ordering. Table ships unassembled.



TRUMPET SQUARE

Product Number	Dimensions	Weight	Zone 1	Zone 2	Zone 3	Zone 4
8718SQTR18	OCCASIONAL TABLE, 18" H x 18" W	54 lb	1004	1029	1054	1079
8724SQTR18	OCCASIONAL TABLE, 18" H x 24" W	61 lb	1019	1044	1070	1095
8730SQTR18	OCCASIONAL TABLE, 18" H x 30" W	71 lb	1177	1206	1236	1265
8736SQTR18	OCCASIONAL TABLE, 18" H x 36" W	82 lb	1302	1335	1367	1400

Square laminate top with metal base. Specify laminate, edge style finish and metal finish when ordering. Table ships unassembled.



DISC ROUND

Product Number	Dimensions	Weight	Zone 1	Zone 2	Zone 3	Zone 4
8724DDISC18	END TABLE, 18" H x 24" L	71 lb	1441	1477	1513	1549
8730DDISC18	END TABLE, 18" H x 30" L	81 lb	1593	1633	1673	1712
8736DDISC18	END TABLE, 18" H x 36" L	92 lb	1740	1784	1827	1870
8742DDISC18	END TABLE, 18" H x 42" L	116 lb	2163	2217	2271	2325

Round laminate top with metal base. Specify laminate, edge style and metal finish when ordering. Table ships unassembled.



DISC SQUARE

Product Number	Dimensions	Weight	Zone 1	Zone 2	Zone 3	Zone 4
8718SQDISC18	END TABLE, 18" H x 18" W	54 lb	1468	1505	1541	1578
8724SQDISC18	END TABLE, 18" H x 24" W	61 lb	1485	1522	1559	1596
8730SQDISC18	END TABLE, 18" H x 30" W	91 lb	1644	1685	1726	1767
8736SQDISC18	END TABLE, 18" H x 36" W	102 lb	1740	1784	1827	1870

Square laminate top with metal base. Specify laminate, edge style and metal finish when ordering. Table ships unassembled.

Edge Style Options



FLAT PVC EDGE

Available in 7 colors to match metal finishes.



SELF EDGE

Matches top laminate.



2MM BIO EDGE

Available in 7 colors to match metal finishes.



2MM PVC WOOD GRAIN EDGE

Available in 9 wood grain colors to match standard laminates.

Specify:

- Product Number
- Finish
- Edge Style
- Laminate Vendor, Pattern and Finish

Fuse Multi-purpose Tables



FUSE

Product Number	Dimensions	Shape	Weight	Zone 1	Zone 2	Zone 3	Zone 4
882424SQFVST129	24" W x 24" L	Square	54 lb	1281	1313	1345	1377
883030SQFVST129	30" W x 30" L	Square	64 lb	1441	1477	1513	1549
883636SQFVST129	36" W x 36" L	Square	76 lb	1561	1600	1639	1678
881848REFVST129	48" W x 18" L	Rectangle	64 lb	1451	1487	1524	1560
881860REFVST129	60" W x 18" L	Rectangle	72 lb	1518	1556	1594	1632
881872REFVST129	72" W x 18" L	Rectangle	79 lb	1609	1649	1689	1730
882430REFVST129	30" W x 24" L	Rectangle	58 lb	1421	1457	1492	1528
882436REFVST129	36" W x 24" L	Rectangle	63 lb	1421	1457	1492	1528
882442REFVST129	42" W x 24" L	Rectangle	68 lb	1518	1556	1594	1632
882448REFVST129	48" W x 24" L	Rectangle	72 lb	1518	1556	1594	1632
882460REFVST129	60" W x 24" L	Rectangle	82 lb	1609	1649	1689	1730
882472REFVST129	72" W x 24" L	Rectangle	91 lb	1829	1875	1920	1966
883036REFVST129	36" W x 30" L	Rectangle	69 lb	1561	1600	1639	1678
883042REFVST129	42" W x 30" L	Rectangle	75 lb	1594	1634	1674	1714
883048REFVST129	48" W x 30" L	Rectangle	81 lb	1594	1634	1674	1714
883060REFVST129	60" W x 30" L	Rectangle	92 lb	1683	1725	1767	1809
883072REFVST129	72" W x 30" L	Rectangle	103 lb	2030	2081	2132	2182
883642REFVST129	42" W x 36" L	Rectangle	82 lb	1745	1789	1832	1876
883648REFVST129	48" W x 36" L	Rectangle	89 lb	1782	1827	1871	1916
883660REFVST129	60" W x 36" L	Rectangle	102 lb	1927	1975	2023	2072
883672REFVST129	72" W x 36" L	Rectangle	115 lb	2119	2172	2225	2278

Overall height is 29". Casters are available on all sizes. See accessories section for accessory pricing. Table ships unassembled.

Edge Style Options



2MM BIO EDGE

Available in 7 colors to match metal finishes.



SELF EDGE

Matches top laminate.



2MM PVC WOOD GRAIN EDGE

Available in 9 wood grain colors to match standard laminates.

Accessories



HARD CASTERS (FOR SOFT SURFACES)

\$133 per table

All bases are standard with floor-leveling glides. Casters are available on select models. See notes below product chart for availability.



VSC SEAM CONNECTOR

W: 2" H: 5" WT: .5 lb

\$142

To join and level tops. Includes 2 connectors, 4 thumb screws, 4 counter sunk threaded metal inserts. Standard in black.



SOFT CASTERS (FOR HARD SURFACES)

\$289 per table

All bases are standard with floor-leveling glides. Casters are available on select models. See notes below product chart for availability.

Specify:

- Product Number
- Finish
- Edge Style
- Laminate Vendor, Pattern and Finish

Trumpet and Disc Multi-purpose Tables



TRUMPET

Product Number	Dimensions	Shape	Weight	Zone 1	Zone 2	Zone 3	Zone 4
8724DTR29	24" DIA x 29" H	Round	61 lb	973	997	1022	1046
8730DTR29	30" DIA x 29" H	Round	71 lb	1128	1156	1184	1213
8736DTR29	36" DIA x 29" H	Round	82 lb	1275	1307	1339	1371
8742DTR29	42" DIA x 29" H	Round	96 lb	1696	1738	1781	1823
8748DTR29	48" DIA x 29" H	Round	112 lb	1731	1774	1818	1861
8724SQTR29	24" W x 29" H	Square	61 lb	1019	1044	1070	1095
8730SQTR29	30" W x 29" H	Square	71 lb	1120	1148	1176	1204
8736SQTR29	36" W x 29" H	Square	82 lb	1302	1335	1367	1400

Round or square laminate top with metal base. Specify laminate, edge style and metal finish when ordering. Table ships unassembled.



DISC

Product Number	Dimensions	Shape	Weight	Zone 1	Zone 2	Zone 3	Zone 4
8724DDISC29	24" DIA x 29" H	Round	71 lb	1441	1477	1513	1549
8730DDISC29	30" DIA x 29" H	Round	81 lb	1593	1633	1673	1712
8736DDISC29	36" DIA x 29" H	Round	92 lb	1644	1685	1726	1767
8742DDISC29	42" DIA x 29" H	Round	116 lb	1740	1784	1827	1870
8748DDISC29	48" DIA x 29" H	Round	132 lb	1768	1812	1856	1901
8730SQDISC29	30" W x 29" H	Square	91 lb	2163	2217	2271	2325
8736SQDISC29	36" W x 29" H	Square	102 lb	2197	2252	2307	2362

Round or square laminate top with metal base. Specify laminate, edge style and metal finish when ordering. Table ships unassembled.

Edge Style Options



FLAT PVC EDGE

Available in 7 colors to match metal finishes.



SELF EDGE

Matches top laminate.



2MM BIO EDGE

Available in 7 colors to match metal finishes.



2MM PVC WOOD GRAIN EDGE

Available in 9 wood grain colors to match standard laminates.

Specify:

- Product Number
- Metal Finish
- Edge Style and Finish
- Laminate Vendor, Pattern and Finish

See pages 16 & 17 for material and finish options.

Tubular Multi-purpose Tables

X-BASE



Product Number	Flip-Top Option	Dimensions	Shape	Weight	Zone 1	Zone 2	Zone 3	Zone 4
8624DX	•	24" DIA	Round	37 lb	783	803	822	842
8630DX	•	30" DIA	Round	47 lb	940	964	987	1010
8636DX	•	36" DIA	Round	58 lb	1089	1116	1143	1171
8642DX	•	42" DIA	Round	72 lb	1517	1555	1593	1631
8648DX	•	48" DIA	Round	88 lb	1554	1593	1632	1671
8624SQX	•	24" W x 24" L	Square	37 lb	830	851	872	892
8630SQX	•	30" W x 30" L	Square	47 lb	992	1017	1042	1066
8636SQX	•	36" W x 36" L	Square	58 lb	1117	1145	1173	1201
8642SQX	•	42" W x 42" L	Square	92 lb	1773	1817	1862	1906
862430REX	•	24" W x 30" L	Rectangle	46 lb	975	999	1024	1048
862436REX	•	24" W x 36" L	Rectangle	46 lb	975	999	1024	1048
863036REX	•	30" W x 36" L	Rectangle	52 lb	1117	1145	1173	1201
863042REX	•	30" W x 42" L	Rectangle	62 lb	1150	1179	1208	1236
863048REX	•	30" W x 48" L	Rectangle	62 lb	1150	1179	1208	1236

One base per table; overall height is 29". Flip-top option is available in all sizes. Casters are available on 48" round and 24", 30", and 36" square table only. See accessories section for accessory pricing. Table ships unassembled.

X-BASE, BAR HEIGHT

Product Number	Dimensions	Shape	Weight	Zone 1	Zone 2	Zone 3	Zone 4
8624DX41	24" DIA	Round	39 lb	842	863	884	905
8630DX41	30" DIA	Round	49 lb	999	1024	1049	1074
8636DX41	36" DIA	Round	60 lb	1149	1178	1206	1235
8624SQX41	24" W x 24" L	Square	39 lb	889	911	933	956
8630SQX41	30" W x 30" L	Square	49 lb	1052	1078	1105	1131
8636SQX41	36" W x 36" L	Square	60 lb	1177	1206	1236	1265

One base per table; overall height is 41". Flip-top option and casters are not available. Table ships unassembled.

4-COLUMN, X-BASE



Product Number	Dimensions	Shape	Weight	Zone 1	Zone 2	Zone 3	Zone 4
8642DX4	42" DIA	Round	87 lb	1813	1858	1904	1949
8648DX4	48" DIA	Round	103 lb	1849	1895	1941	1988
8654DX4	54" DIA	Round	121 lb	2286	2343	2400	2457
8660DX4	60" DIA	Round	140 lb	2355	2414	2473	2532
8642SQX4	42" W x 42" L	Square	87 lb	1836	1882	1928	1974
8648SQX4	48" W x 48" L	Square	103 lb	2069	2121	2172	2224
8654SQX4	54" W x 54" L	Square	121 lb	2290	2347	2404	2462
8660SQX4	60" W x 60" L	Square	140 lb	2338	2396	2455	2513

One base per table; overall height is 29". Flip-top option not available. Casters are available on 42" and 48" tables only. See accessories section for accessory pricing. Table ships unassembled.

Specify:

- Product Number
- Metal Finish
- Edge Style and Finish
- Grommet Position
- Laminated Vendor, Pattern and Finish
- Modesty Panel Finish
- Power Option and Color
- Flip-Top Option

See pages 16 & 17 for material and finish options.

Tubular Multi-purpose Tables



T-BASE

Product Number	Flip-Top Option	Folding Option	Dimensions	Shape	Weight	Zone 1	Zone 2	Zone 3	Zone 4
862430RET	•		24" W x 30" L	Rectangle	54 lb	1142	1171	1199	1228
862436RET	•		24" W x 36" L	Rectangle	54 lb	1142	1171	1199	1228
862442RET	•		24" W x 42" L	Rectangle	62 lb	1241	1272	1303	1334
862448RET	•		24" W x 48" L	Rectangle	62 lb	1241	1272	1303	1334
862454RET	•		24" W x 54" L	Rectangle	70 lb	1332	1365	1399	1432
862460RET	•	•	24" W x 60" L	Rectangle	70 lb	1332	1365	1399	1432
862466RET	•	•	24" W x 66" L	Rectangle	79 lb	1557	1596	1635	1674
862472RET	•	•	24" W x 72" L	Rectangle	79 lb	1557	1596	1635	1674
863036RET	•		30" W x 36" L	Rectangle	60 lb	1285	1317	1349	1381
863042RET	•		30" W x 42" L	Rectangle	70 lb	1318	1351	1384	1417
863048RET	•		30" W x 48" L	Rectangle	70 lb	1318	1351	1384	1417
863054RET	•		30" W x 54" L	Rectangle	81 lb	1405	1440	1475	1510
863060RET	•	•	30" W x 60" L	Rectangle	81 lb	1405	1440	1475	1510
863066RET	•	•	30" W x 66" L	Rectangle	91 lb	1674	1716	1758	1800
863072RET	•	•	30" W x 72" L	Rectangle	91 lb	1762	1806	1850	1894
863078RET	•	•	30" W x 78" L	Rectangle	102 lb	2108	2161	2213	2266
863084RET	•	•	30" W x 84" L	Rectangle	102 lb	2108	2161	2213	2266
863090RET		•	30" W x 90" L	Rectangle	112 lb	2140	2194	2247	2300
863096RET		•	30" W x 96" L	Rectangle	112 lb	2140	2194	2247	2300
863642RET	•		36" W x 42" L	Rectangle	79 lb	1472	1509	1546	1582
863648RET	•		36" W x 48" L	Rectangle	79 lb	1510	1548	1586	1623
863660RET	•	•	36" W x 60" L	Rectangle	91 lb	1658	1699	1741	1782
863666RET	•	•	36" W x 66" L	Rectangle	104 lb	1794	1839	1884	1929
863672RET	•	•	36" W x 72" L	Rectangle	104 lb	1852	1898	1945	1991
863678RET		•	36" W x 78" L	Rectangle	117 lb	2367	2426	2485	2545
863684RET		•	36" W x 84" L	Rectangle	117 lb	2367	2426	2485	2545
863690RET			36" W x 90" L	Rectangle	129 lb	2377	2436	2496	2555
863696RET			36" W x 96" L	Rectangle	129 lb	2377	2436	2496	2555
863654RTT	•		36" W x 54" L	Racetrack	91 lb	1744	1788	1831	1875
863660RTT	•		36" W x 60" L	Racetrack	91 lb	1744	1788	1831	1875
863666RTT	•		36" W x 66" L	Racetrack	104 lb	1987	2037	2086	2136
863672RTT	•		36" W x 72" L	Racetrack	104 lb	1987	2037	2086	2136
863678RTT			36" W x 78" L	Racetrack	117 lb	2393	2453	2513	2572
863684RTT			36" W x 84" L	Racetrack	117 lb	2393	2453	2513	2572
863690RTT			36" W x 90" L	Racetrack	129 lb	2398	2458	2518	2578
863696RTT			36" W x 96" L	Racetrack	129 lb	2398	2458	2518	2578
863054BT	•		30" W x 54" L	Bullet	81 lb	1592	1632	1672	1711
863060BT	•		30" W x 60" L	Bullet	81 lb	1672	1714	1756	1797
863654BT	•		36" W x 54" L	Bullet	91 lb	1779	1823	1868	1912
863660BT	•		36" W x 60" L	Bullet	91 lb	1779	1823	1868	1912
863672BT	•		36" W x 72" L	Bullet	104 lb	1985	2035	2084	2134
862448HT	•		24" W x 48" L	Half Moon	62 lb	1265	1297	1328	1360
863060HT	•		30" W x 60" L	Half Moon	81 lb	1502	1540	1577	1615
863672HT	•		36" W x 72" L	Half Moon	104 lb	1985	2035	2084	2134
863060TPT	•		30" W x 60" L	Trapezoid	81 lb	1592	1632	1672	1711
863672TPT	•		36" W x 72" L	Trapezoid	104 lb	1985	2035	2084	2134

Top View:



Rectangle



Racetrack



Bullet



Half Moon



Trapezoid

Specify:

- Product Number
- Finish
- Edge Style
- Grommet Position
- Laminate Vendor, Pattern and Finish
- Modesty Panel Finish
- Power Option and Color
- Flip-Top Option
- Folding Option

See pages 16 & 17 for material and finish options.

Two bases per table; overall height is 29". Flip-top option is not available on 30" tables longer than 84" or 36" tables longer than 72". Casters are available on all sizes. Table ships unassembled. Folding tables available with Flat PVC Edge only. A table can either be Flip-top or Folding, but not both when available.

Tubular Tables

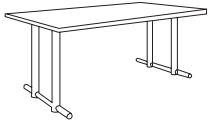

DOUBLE COLUMN, T-BASE

Product Number	Folding Option	Dimensions	Shape	Weight	Zone 1	Zone 2	Zone 3	Zone 4
863666RET2	•	36" W x 66" L	Rectangle	124 lb	2100	2152	2205	2258
863672RET2	•	36" W x 72" L	Rectangle	124 lb	2157	2211	2265	2319
863678RET2	•	36" W x 78" L	Rectangle	137 lb	2673	2740	2807	2873
863684RET2	•	36" W x 84" L	Rectangle	137 lb	2673	2740	2807	2873
863690RET2	•	36" W x 90" L	Rectangle	149 lb	2683	2750	2817	2884
863696RET2	•	36" W x 96" L	Rectangle	149 lb	2683	2750	2817	2884
864278RET2	•	42" W x 78" L	Rectangle	151 lb	3047	3123	3199	3276
864284RET2	•	42" W x 84" L	Rectangle	151 lb	3047	3123	3199	3276
863654RTT2		36" W x 54" L	Racetrack	111 lb	2052	2103	2155	2206
863660RTT2		36" W x 60" L	Racetrack	111 lb	2052	2103	2155	2206
863666RTT2		36" W x 66" L	Racetrack	124 lb	2294	2351	2409	2466
863672RTT2		36" W x 72" L	Racetrack	124 lb	2294	2351	2409	2466
863678RTT2		36" W x 78" L	Racetrack	132 lb	2701	2769	2836	2904
863684RTT2		36" W x 84" L	Racetrack	132 lb	2701	2769	2836	2904
863690RTT2		36" W x 90" L	Racetrack	149 lb	2705	2773	2840	2908
863696RTT2		36" W x 96" L	Racetrack	149 lb	2705	2773	2840	2908
864278RTT2		42" W x 78" L	Racetrack	166 lb	3069	3146	3222	3299
864284RTT2		42" W x 84" L	Racetrack	166 lb	3069	3146	3222	3299
864878RTT2		48" W x 78" L	Racetrack	166 lb	3073	3150	3227	3303
864884RTT2		48" W x 84" L	Racetrack	166 lb	3073	3150	3227	3303

Two bases per table; overall height is 29". Flip-top option not available. Casters are available on all sizes. See accessories section for accessory pricing. Table ships unassembled. Folding tables available with Flat PVC Edge only.

CONNECTOR TABLE

Product Number	Dimensions	Shape	Weight	Zone 1	Zone 2	Zone 3	Zone 4
8624RC90	24" W x 24" L	Radius	17 lb	595	610	625	640
8630RC90	30" W x 30" L	Radius	27 lb	760	779	798	817
863036CRC90T	30" W x 36" L	Crescent	46 lb	1216	1246	1277	1307
863642CRC90T	36" W x 42" L	Crescent	59 lb	1762	1806	1850	1894

Height is 29".

Specify:

- Product Number
- Finish
- Edge Style
- Grommet Position
- Laminate Vendor, Pattern and Finish
- Modesty Panel Finish
- Power Option and Color
- Folding Option

See pages 16 & 17 for material and finish options.

Edge Style Options



FLAT PVC EDGE

Available in 7 colors to match metal finishes.



SELF EDGE

Matches top laminate.



2MM BIO EDGE

Available in 7 colors to match metal finishes.



2MM PVC WOOD GRAIN EDGE

Available in 9 wood grain colors to match standard laminates.

Tubular Accessories

Accessories



HARD CASTERS (FOR SOFT SURFACES)

\$133 per table

All bases are standard with floor-leveling glides. Casters are available on select models. See notes below products chart for availability.



SOFT CASTERS (FOR HARD SURFACES)

\$289 per table

All bases are standard with floor-leveling glides. Casters are available on select models. See notes below products chart for availability.



FLIP-TOP OPTION

\$219 Tables with One Base
\$438 Tables with Two Bases

Available on select products. See product chart for availability.

FOLDING OPTION

\$904 Tables Smaller than 72" L
\$1128 Tables 72" L or Larger

Available on select sizes with Flat PVC Edge only.

WHEELCHAIR HEIGHT UPCHARGE

\$59

Recommended wheelchair height is 31". For Tubular tables with X and T base with or without casters or modesty panels.



CTRS ROUND GROMMET

DIA: 2" H: 1" WT: .2 lb

\$38

Available positioned at left, right, and/or center - specify location(s) when ordering.

CTRG OVAL GROMMET

W: 3" L: 5" H: 1" WT: .2 lb

\$62

Available positioned at left, right, and/or center - specify location(s) when ordering.



CSC SEAM CONNECTOR

W: 2" H: 5" WT: .5 lb

\$142

To join and level tops. Includes 2 connectors, 4 thumb screws, 4 counter sunk threaded metal inserts.



PMP-SR42 MODESTY PANEL

Fits 42" Top Size L: 39" H: 10" WT: 6 lb

PMP-SR48 MODESTY PANEL

Fits 48" Top Size L: 45" H: 10" WT: 6 lb

PMP-SR54 MODESTY PANEL

Fits 54" Top Size L: 51" H: 10" WT: 7 lb

PMP-SR60 MODESTY PANEL

Fits 60" Top Size L: 57" H: 10" WT: 8 lb

PMP-SR66 MODESTY PANEL

Fits 66" Top Size L: 63" H: 10" WT: 9 lb

PMP-SR72 MODESTY PANEL

Fits 72" Top Size L: 69" H: 10" WT: 10 lb

\$441 All Sizes

Available on rectangle top tables 42" - 72" in length. Perforated metal panel available in black or silver—specify color when ordering. Panel is hinged when used in conjunction with flip-top option.



COVC2P2U-B POWER, CLAMP MOUNTED

Black, 2 Power, 2 USB

COVC2P2U-S POWER, CLAMP MOUNTED

Silver Pearl, 2 Power, 2 USB

COVC2P2U-W POWER, CLAMP MOUNTED

Gloss White, 2 Power, 2 USB

\$629 All Colors

Cord is 108" long.



COVS2P2U-B POWER, SCREW MOUNTED

Black, 2 Power, 2 USB

COVS2P2U-S POWER, SCREW MOUNTED

Silver Pearl, 2 Power, 2 USB

COVS2P2U-W POWER, SCREW MOUNTED

Gloss White, 2 Power, 2 USB

\$629 All Colors

Cord is 108" long.



CWMT PVC SNAP TO LEG WIRE MANAGER

\$59



VELCROWIREMGR VELCRO WIRE MANAGER

\$19

Task Chairs

Delta with Casters



82DT35UP UPH SEAT AND BACK, CASTERS, 18"

W: 22" D: 21.5" H: 32" SW: 18.5" SD: 18" SH: 18" AH: - WT: 16 lb COM: .7 yd WT CAP: 500 lb

ZONE	B/COM	C	D	E	F	G	H	I	J	GENERAL INFORMATION
1	956	970	984	1000	1028	1056	1084	1111	1139	MATERIAL: Metal MOIS. BARR: - 1/2" SEAT FOAM: \$22
2	980	994	1008	1024	1052	1080	1108	1135	1163	
3	1003	1017	1031	1047	1075	1103	1131	1158	1186	
4	1027	1041	1055	1071	1099	1127	1155	1182	1210	

Price includes hard casters (for soft surfaces). Four chairs nest 44" deep, each additional chair adds 8".

83DT15UP UPH SEAT AND BACK, CASTERS, 22"

W: 24" D: 21.5" H: 32" SW: 22" SD: 18" SH: 18" AH: - WT: 20.5 lb COM: .7 yd WT CAP: 500 lb

ZONE	B/COM	C	D	E	F	G	H	I	J	GENERAL INFORMATION
1	1025	1039	1053	1069	1097	1125	1153	1180	1208	MATERIAL: Metal MOIS. BARR: - 1/2" SEAT FOAM: \$34
2	1050	1064	1078	1094	1122	1150	1178	1205	1233	
3	1076	1090	1104	1120	1148	1176	1204	1231	1259	
4	1101	1115	1129	1145	1173	1201	1229	1256	1284	

Price includes hard casters (for soft surfaces). Four chairs nest 44" deep, each additional chair adds 8".

82DT35US UPH SEAT AND PLASTIC BACK, CASTERS, 18"

W: 22" D: 21.5" H: 32" SW: 18.5" SD: 18" SH: 18" AH: - WT: 16 lb COM: .35 yd WT CAP: 500 lb

ZONE	B/COM	C	D	E	F	G	H	I	J	GENERAL INFORMATION
1	905	912	918	927	941	954	968	982	996	MATERIAL: Metal MOIS. BARR: - 1/2" SEAT FOAM: \$22
2	927	934	940	949	963	976	990	1004	1018	
3	950	957	963	972	986	999	1013	1027	1041	
4	972	979	985	994	1008	1021	1035	1049	1063	

Price includes hard casters (for soft surfaces). Four chairs nest 44" deep, each additional chair adds 8".

83DT15US UPH SEAT AND PLASTIC BACK, CASTERS, 22"

W: 24" D: 21.5" H: 32" SW: 22" SD: 18" SH: 18" AH: - WT: 20.5 lb COM: .35 yd WT CAP: 500 lb

ZONE	B/COM	C	D	E	F	G	H	I	J	GENERAL INFORMATION
1	971	978	984	993	1007	1020	1034	1048	1062	MATERIAL: Metal MOIS. BARR: - 1/2" SEAT FOAM: \$34
2	995	1002	1008	1017	1031	1044	1058	1072	1086	
3	1019	1026	1032	1041	1055	1068	1082	1096	1110	
4	1043	1050	1056	1065	1079	1092	1106	1120	1134	

Price includes hard casters (for soft surfaces). Four chairs nest 44" deep, each additional chair adds 8".

82DT35 PLASTIC SEAT AND BACK, CASTERS, 18"

W: 22" D: 21.5" H: 32" SW: 18.5" SD: 18" SH: 18" AH: - WT: 16 lb COM: - WT CAP: 500 lb

Zone	1	2	3	4	GENERAL INFORMATION
	751	770	789	807	MATERIAL: Metal MOIS. BARR: -

Price includes hard casters (for soft surfaces). Four chairs nest 44" deep, each additional chair adds 8".

83DT15 PLASTIC SEAT AND BACK, CASTERS, 22"

W: 24" D: 21.5" H: 32" SW: 22" SD: 18" SH: 18" AH: - WT: 20.5 lb COM: - WT CAP: 500 lb

Zone	1	2	3	4	GENERAL INFORMATION
	803	823	843	863	MATERIAL: Metal MOIS. BARR: -

Price includes hard casters (for soft surfaces). Four chairs nest 44" deep, each additional chair adds 8".

Specify:

- Product Number
- Seat Finish
- Back Finish
- Fabric Vendor, Pattern and Color
- Metal Finish

See pages 16 & 17 for material and finish options.

Accessories

SOFT CASTERS (FOR HARD SURFACES)

\$32

Delta with Glides



82DT34UP UPH SEAT AND BACK, GLIDES, 18"

W: 22"	D: 21.5"	H: 32"	SW: 18.5"	SD: 18"	SH: 18"	AH: -	WT: 16 lb	COM: .7 yd	WT CAP: 500 lb	
ZONE	B/COM	C	D	E	F	G	H	I	J	GENERAL INFORMATION
1	956	970	984	1000	1028	1056	1084	1111	1139	MATERIAL: Metal MOIS. BARR: - 1/2" SEAT FOAM: \$22
2	980	994	1008	1024	1052	1080	1108	1135	1163	
3	1003	1017	1031	1047	1075	1103	1131	1158	1186	
4	1027	1041	1055	1071	1099	1127	1155	1182	1210	

Four chairs nest 44" deep, each additional chair adds 8".

83DT14UP UPH SEAT AND BACK, GLIDES, 22"

W: 24"	D: 21.5"	H: 32"	SW: 22"	SD: 18"	SH: 18"	AH: -	WT: 20.5 lb	COM: .7 yd	WT CAP: 500 lb	
ZONE	B/COM	C	D	E	F	G	H	I	J	GENERAL INFORMATION
1	1025	1039	1053	1069	1097	1125	1153	1180	1208	MATERIAL: Metal MOIS. BARR: - 1/2" SEAT FOAM: \$34
2	1050	1064	1078	1094	1122	1150	1178	1205	1233	
3	1076	1090	1104	1120	1148	1176	1204	1231	1259	
4	1101	1115	1129	1145	1173	1201	1229	1256	1284	

Four chairs nest 44" deep, each additional chair adds 8".

82DT34US UPH SEAT AND PLASTIC BACK, GLIDES, 18"

W: 22"	D: 21.5"	H: 32"	SW: 18.5"	SD: 18"	SH: 18"	AH: -	WT: 16 lb	COM: .35 yd	WT CAP: 500 lb	
ZONE	B/COM	C	D	E	F	G	H	I	J	GENERAL INFORMATION
1	905	912	918	927	941	954	968	982	996	MATERIAL: Metal MOIS. BARR: - 1/2" SEAT FOAM: \$22
2	927	934	940	949	963	976	990	1004	1018	
3	950	957	963	972	986	999	1013	1027	1041	
4	972	979	985	994	1008	1021	1035	1049	1063	

Four chairs nest 44" deep, each additional chair adds 8".

83DT14US UPH SEAT AND PLASTIC BACK, GLIDES, 22"

W: 24"	D: 21.5"	H: 32"	SW: 22"	SD: 18"	SH: 18"	AH: -	WT: 20.5 lb	COM: .35 yd	WT CAP: 500 lb	
ZONE	B/COM	C	D	E	F	G	H	I	J	GENERAL INFORMATION
1	971	978	984	993	1007	1020	1034	1048	1062	MATERIAL: Metal MOIS. BARR: - 1/2" SEAT FOAM: \$34
2	995	1002	1008	1017	1031	1044	1058	1072	1086	
3	1019	1026	1032	1041	1055	1068	1082	1096	1110	
4	1043	1050	1056	1065	1079	1092	1106	1120	1134	

Four chairs nest 44" deep, each additional chair adds 8".

82DT34 PLASTIC SEAT AND BACK, GLIDES, 18"

W: 22"	D: 21.5"	H: 32"	SW: 18.5"	SD: 18"	SH: 18"	AH: -	WT: 16 lb	COM: -	WT CAP: 500 lb
Zone	1	2	3	4	GENERAL INFORMATION				
	751	770	789	807	MATERIAL: Metal MOIS. BARR: -				

Four chairs nest 44" deep, each additional chair adds 8".

83DT14 PLASTIC SEAT AND BACK, GLIDES, 22"

W: 24"	D: 21.5"	H: 32"	SW: 22"	SD: 18"	SH: 18"	AH: -	WT: 20.5 lb	COM: -	WT CAP: 500 lb
Zone	1	2	3	4	GENERAL INFORMATION				
	803	823	843	863	MATERIAL: Metal MOIS. BARR: -				

Four chairs nest 44" deep, each additional chair adds 8".

Specify:

- Product Number
- Seat Finish
- Back Finish
- Fabric Vendor, Pattern and Color
- Metal Finish

See pages 16 & 17 for material and finish options.

Delta with Arms and Casters



82DT25UP UPH SEAT AND BACK, ARMS, CASTERS, 18"

W: 23.5" D: 21.5" H: 32" SW: 18.5" SD: 18" SH: 18" AH: 25.5" WT: 19 lb COM: .7 yd WT CAP: 500 lb

ZONE	B/COM	C	D	E	F	G	H	I	J	GENERAL INFORMATION
1	1025	1039	1053	1069	1097	1125	1153	1180	1208	MATERIAL: Metal MOIS. BARR: - 1/2" SEAT FOAM: \$22
2	1050	1064	1078	1094	1122	1150	1178	1205	1233	
3	1076	1090	1104	1120	1148	1176	1204	1231	1259	
4	1101	1115	1129	1145	1173	1201	1229	1256	1284	

Price includes hard casters (for soft surfaces). Four chairs nest 44" deep, each additional chair adds 8".

83DT05UP UPH SEAT AND BACK, ARMS, CASTERS, 22"

W: 25.5" D: 21.5" H: 32" SW: 22" SD: 18" SH: 18" AH: 25.5" WT: 22 lb COM: .7 yd WT CAP: 500 lb

ZONE	B/COM	C	D	E	F	G	H	I	J	GENERAL INFORMATION
1	1101	1115	1129	1145	1173	1201	1229	1256	1284	MATERIAL: Metal MOIS. BARR: - 1/2" SEAT FOAM: \$34
2	1128	1142	1156	1172	1200	1228	1256	1283	1311	
3	1155	1169	1183	1199	1227	1255	1283	1310	1338	
4	1183	1197	1211	1227	1255	1283	1311	1338	1366	

Price includes hard casters (for soft surfaces). Four chairs nest 44" deep, each additional chair adds 8".

82DT25US UPH SEAT AND PLASTIC BACK, ARMS, CASTERS, 18"

W: 23.5" D: 21.5" H: 32" SW: 18.5" SD: 18" SH: 18" AH: 25.5" WT: 19 lb COM: .35 yd WT CAP: 500 lb

ZONE	B/COM	C	D	E	F	G	H	I	J	GENERAL INFORMATION
1	973	980	986	995	1009	1022	1036	1050	1064	MATERIAL: Metal MOIS. BARR: - 1/2" SEAT FOAM: \$22
2	997	1004	1010	1019	1033	1046	1060	1074	1088	
3	1021	1028	1034	1043	1057	1070	1084	1098	1112	
4	1046	1053	1059	1068	1082	1095	1109	1123	1137	

Price includes hard casters (for soft surfaces). Four chairs nest 44" deep, each additional chair adds 8".

83DT05US UPH SEAT AND PLASTIC BACK, ARMS, CASTERS, 22"

W: 25.5" D: 21.5" H: 32" SW: 22" SD: 18" SH: 18" AH: 25.5" WT: 22 lb COM: .35 yd WT CAP: 500 lb

ZONE	B/COM	C	D	E	F	G	H	I	J	GENERAL INFORMATION
1	1101	1115	1129	1145	1173	1201	1229	1256	1284	MATERIAL: Metal MOIS. BARR: - 1/2" SEAT FOAM: \$34
2	1128	1142	1156	1172	1200	1228	1256	1283	1311	
3	1155	1169	1183	1199	1227	1255	1283	1310	1338	
4	1183	1197	1211	1227	1255	1283	1311	1338	1366	

Price includes hard casters (for soft surfaces). Four chairs nest 44" deep, each additional chair adds 8".

82DT25 PLASTIC SEAT AND BACK, ARMS, CASTERS, 18"

W: 23.5" D: 21.5" H: 32" SW: 18.5" SD: 18" SH: 18" AH: 25.5" WT: 19 lb COM: - WT CAP: 500 lb

Zone	1	2	3	4	GENERAL INFORMATION
	820	840	861	882	MATERIAL: Metal MOIS. BARR: -

Price includes hard casters (for soft surfaces). Four chairs nest 44" deep, each additional chair adds 8".

83DT05 PLASTIC SEAT AND BACK, ARMS, CASTERS, 22"

W: 25.5" D: 21.5" H: 32" SW: 22" SD: 18" SH: 18" AH: 25.5" WT: 22 lb COM: - WT CAP: 500 lb

Zone	1	2	3	4	GENERAL INFORMATION
	876	898	920	942	MATERIAL: Metal MOIS. BARR: -

Price includes hard casters (for soft surfaces). Four chairs nest 44" deep, each additional chair adds 8".

- Specify:
- Product Number
 - Seat Finish
 - Back Finish
 - Fabric Vendor, Pattern and Color
 - Metal Finish

See pages 16 & 17 for material and finish options.

SOFT CASTERS (FOR HARD SURFACES)

\$32

Accessories

Delta with Arms and Glides



82DT24UP UPH SEAT AND BACK, ARMS, GLIDES, 18"

W: 23.5" D: 21.5" H: 32" SW: 18.5" SD: 18" SH: 18" AH: 25.5" WT: 19 lb COM: .7 yd WT CAP: 500 lb

ZONE	B/COM	C	D	E	F	G	H	I	J	GENERAL INFORMATION
1	1025	1039	1053	1069	1097	1125	1153	1180	1208	MATERIAL: Metal MOIS. BARR: - 1/2" SEAT FOAM: \$22
2	1050	1064	1078	1094	1122	1150	1178	1205	1233	
3	1076	1090	1104	1120	1148	1176	1204	1231	1259	
4	1101	1115	1129	1145	1173	1201	1229	1256	1284	

Four chairs nest 44" deep, each additional chair adds 8".

83DT04UP UPH SEAT AND BACK, ARMS, GLIDES, 22"

W: 25.5" D: 21.5" H: 32" SW: 22" SD: 18" SH: 18" AH: 25.5" WT: 22 lb COM: .7 yd WT CAP: 500 lb

ZONE	B/COM	C	D	E	F	G	H	I	J	GENERAL INFORMATION
1	1101	1115	1129	1145	1173	1201	1229	1256	1284	MATERIAL: Metal MOIS. BARR: - 1/2" SEAT FOAM: \$34
2	1128	1142	1156	1172	1200	1228	1256	1283	1311	
3	1155	1169	1183	1199	1227	1255	1283	1310	1338	
4	1183	1197	1211	1227	1255	1283	1311	1338	1366	

Four chairs nest 44" deep, each additional chair adds 8".

82DT24US UPH SEAT AND PLASTIC BACK, ARMS, GLIDES, 18"

W: 23.5" D: 21.5" H: 32" SW: 18.5" SD: 18" SH: 18" AH: 25.5" WT: 19 lb COM: .35 yd WT CAP: 500 lb

ZONE	B/COM	C	D	E	F	G	H	I	J	GENERAL INFORMATION
1	973	980	986	995	1009	1022	1036	1050	1064	MATERIAL: Metal MOIS. BARR: - 1/2" SEAT FOAM: \$22
2	997	1004	1010	1019	1033	1046	1060	1074	1088	
3	1021	1028	1034	1043	1057	1070	1084	1098	1112	
4	1046	1053	1059	1068	1082	1095	1109	1123	1137	

Four chairs nest 44" deep, each additional chair adds 8".

83DT04US UPH SEAT PLASTIC BACK, ARMS, GLIDES, 22"

W: 25.5" D: 21.5" H: 32" SW: 22" SD: 18" SH: 18" AH: 25.5" WT: 22 lb COM: .35 yd WT CAP: 500 lb

ZONE	B/COM	C	D	E	F	G	H	I	J	GENERAL INFORMATION
1	1044	1051	1057	1066	1080	1093	1107	1121	1135	MATERIAL: Metal MOIS. BARR: - 1/2" SEAT FOAM: \$34
2	1070	1077	1083	1092	1106	1119	1133	1147	1161	
3	1096	1103	1109	1118	1132	1145	1159	1173	1187	
4	1122	1129	1135	1144	1158	1171	1185	1199	1213	

Four chairs nest 44" deep, each additional chair adds 8".

82DT24 PLASTIC SEAT AND BACK, ARMS, GLIDES, 18"

W: 23.5" D: 21.5" H: 32" SW: 18.5" SD: 18" SH: 18" AH: 25.5" WT: 19 lb COM: - WT CAP: 500 lb

Zone	1	2	3	4	GENERAL INFORMATION
	820	840	861	882	MATERIAL: Metal MOIS. BARR: -

Four chairs nest 44" deep, each additional chair adds 8".

83DT04 PLASTIC SEAT AND BACK, ARMS, GLIDES, 22"

W: 25.5" D: 21.5" H: 32" SW: 22" SD: 18" SH: 18" AH: 25.5" WT: 22 lb COM: - WT CAP: 500 lb

Zone	1	2	3	4	GENERAL INFORMATION
	876	898	920	942	MATERIAL: Metal MOIS. BARR: -

Four chairs nest 44" deep, each additional chair adds 8".

Specify:

- Product Number
- Seat Finish
- Back Finish
- Fabric Vendor, Pattern and Color
- Metal Finish

See pages 16 & 17 for material and finish options.



7020651 SIDE CHAIR, GSA

W: 19.75" D: 23" H: 32.5-35.25" SW: 19.75" SD: 18.5" SH: 18-20.75" AH: - WT: 27.7 lb COM: 1.2 yd WT CAP: 300 lb

ZONE	B/COM	C	D	E	F	G	H	I	J	GENERAL INFORMATION
1	929	953	976	1005	1053	1100	1148	1194	1242	MATERIAL: Poly MOIS. BARR: \$6
2	952	976	999	1028	1076	1123	1171	1217	1265	
3	975	999	1022	1051	1099	1146	1194	1240	1288	
4	997	1021	1044	1073	1121	1168	1216	1262	1310	

Price includes casters. You must specify a carpet caster or hard-surface caster when ordering. Glides available upon request.



7320651 ARM CHAIR, GSA

W: 25.75" D: 23" H: 32.5-35.25" SW: 19.75" SD: 18.5" SH: 18-20.75" AH: 25-30.5" WT: 35.5 lb COM: 1.2 yd WT CAP: 300 lb

ZONE	B/COM	C	D	E	F	G	H	I	J	GENERAL INFORMATION
1	1075	1099	1122	1151	1199	1246	1294	1340	1388	MATERIAL: Poly MOIS. BARR: \$6
2	1101	1125	1148	1177	1225	1272	1320	1366	1414	
3	1128	1152	1175	1204	1252	1299	1347	1393	1441	
4	1154	1178	1201	1230	1278	1325	1373	1419	1467	

Price includes casters. You must specify a carpet caster or hard-surface caster when ordering. Glides available upon request.



7200650 FLOOR ROCKER, GSA

W: 19.75" D: 23" H: 25" SW: 19.75" SD: 18.5" SH: 8" AH: - WT: 14.9 lb COM: 1.2 yd WT CAP: 300 lb

ZONE	B/COM	C	D	E	F	G	H	I	J	GENERAL INFORMATION
1	554	578	601	630	678	725	773	819	867	MATERIAL: Poly MOIS. BARR: \$6
2	567	591	614	643	691	738	786	832	880	
3	581	605	628	657	705	752	800	846	894	
4	594	618	641	670	718	765	813	859	907	



7200651 FLOOR ROCKER WITH ARMS, GSA

W: 25.75" D: 23" H: 25" SW: 19.75" SD: 18.5" SH: 8" AH: 15-17.75" WT: 22.7 lb COM: 1.2 yd WT CAP: 300 lb

ZONE	B/COM	C	D	E	F	G	H	I	J	GENERAL INFORMATION
1	707	731	754	783	831	878	926	972	1020	MATERIAL: Poly MOIS. BARR: \$6
2	724	748	771	800	848	895	943	989	1037	
3	741	765	788	817	865	912	960	1006	1054	
4	759	783	806	835	883	930	978	1024	1072	



7110651 BASE/TABLE, GSA

W: 23" D: 23" H: 16.25-19" SW: - SD: - SH: - AH: - WT: 12.8 lb COM: - WT CAP: -

Zone	1	2	3	4	GENERAL INFORMATION
	457	468	480	491	MATERIAL: Poly MOIS. BARR: -

Price includes casters. You must specify a carpet caster or hard-surface caster when ordering. Glides available upon request.

Specify:
 Product Number
 Fabric Vendor, Pattern and Color
 Caster Option
See pages 16 & 17 for material and finish options.

Chapel Furniture



7202730 SIDE CHAIR, UPH SEAT, UPH BARREL BACK, WOOD BACKSIDE, STACKING

W: 20"	D: 22"	H: 32"	SW: 19.25"	SD: 17"	SH: 18"	AH: -	WT: 17 lb	COM: .7 yd	WT CAP: 300 lb	
ZONE	B/COM	C	D	E	F	G	H	I	J	GENERAL INFORMATION
1	604	618	632	648	676	704	732	759	787	MATERIAL: Beech MOIS. BARR: \$5 2" SEAT FOAM: \$25
2	619	633	647	663	691	719	747	774	802	
3	634	648	662	678	706	734	762	789	817	
4	648	662	676	692	720	748	776	803	831	

Lumbar area has fabric only, no foam.



7328730 ARM CHAIR, UPH SEAT, UPH BARREL BACK, WOOD BACKSIDE, STACKING

W: 22"	D: 22"	H: 32"	SW: 19.25"	SD: 17"	SH: 18"	AH: 25.75"	WT: 19 lb	COM: .7 yd	WT CAP: 300 lb	
ZONE	B/COM	C	D	E	F	G	H	I	J	GENERAL INFORMATION
1	741	755	769	785	813	841	869	896	924	MATERIAL: Beech MOIS. BARR: \$5 2" SEAT FOAM: \$25
2	759	773	787	803	831	859	887	914	942	
3	777	791	805	821	849	877	905	932	960	
4	796	810	824	840	868	896	924	951	979	

Lumbar area has fabric only, no foam.



7202731 SIDE CHAIR, UPH SEAT, PARTIALLY UPH BARREL BACK, WOOD BACKSIDE, STACKING

W: 20"	D: 22"	H: 32"	SW: 19.25"	SD: 17"	SH: 18"	AH: -	WT: 17 lb	COM: .6 yd	WT CAP: 300 lb	
ZONE	B/COM	C	D	E	F	G	H	I	J	GENERAL INFORMATION
1	618	630	641	655	679	703	727	750	774	MATERIAL: Beech MOIS. BARR: \$5 2" SEAT FOAM: \$25
2	633	645	656	670	694	718	742	765	789	
3	648	660	671	685	709	733	757	780	804	
4	664	676	687	701	725	749	773	796	820	



7328731 ARM CHAIR, UPH SEAT, PARTIALLY UPH BARREL BACK, WOOD BACKSIDE, STACKING

W: 22"	D: 22"	H: 32"	SW: 19.25"	SD: 17"	SH: 18"	AH: 25.75"	WT: 19 lb	COM: .6 yd	WT CAP: 300 lb	
ZONE	B/COM	C	D	E	F	G	H	I	J	GENERAL INFORMATION
1	754	766	777	791	815	839	863	886	910	MATERIAL: Beech MOIS. BARR: \$5 2" SEAT FOAM: \$25
2	773	785	796	810	834	858	882	905	929	
3	791	803	814	828	852	876	900	923	947	
4	810	822	833	847	871	895	919	942	966	



7202735 SIDE CHAIR, UPH SEAT, UPH BARREL BACK, UPH BACKSIDE, STACKING

W: 20"	D: 22"	H: 32"	SW: 19.25"	SD: 17"	SH: 18"	AH: -	WT: 17 lb	COM: 1.3 yd	WT CAP: 300 lb	
ZONE	B/COM	C	D	E	F	G	H	I	J	GENERAL INFORMATION
1	688	714	739	770	822	872	924	975	1027	MATERIAL: Beech MOIS. BARR: \$5 2" SEAT FOAM: \$25
2	705	731	756	787	839	889	941	992	1044	
3	721	747	772	803	855	905	957	1008	1060	
4	738	764	789	820	872	922	974	1025	1077	

Lumbar area has fabric only, no foam.



7328735 ARM CHAIR, UPH SEAT, UPH BARREL BACK, UPH BACKSIDE, STACKING

W: 22"	D: 22"	H: 32"	SW: 19.25"	SD: 17"	SH: 18"	AH: 25.75"	WT: 19 lb	COM: 1.3 yd	WT CAP: 300 lb	
ZONE	B/COM	C	D	E	F	G	H	I	J	GENERAL INFORMATION
1	827	853	878	909	961	1011	1063	1114	1166	MATERIAL: Beech MOIS. BARR: \$5 2" SEAT FOAM: \$25
2	847	873	898	929	981	1031	1083	1134	1186	
3	867	893	918	949	1001	1051	1103	1154	1206	
4	887	913	938	969	1021	1071	1123	1174	1226	

Lumbar area has fabric only, no foam.

Specify:

- Product Number
- Wood Finish
- Fabric Vendor, Pattern and Color

See pages 16 & 17 for material and finish options.



7028737 SE SIDE CHAIR, UPH SEAT, UPH BARREL BACK, WOOD BACKSIDE, STACKING

W: 20" D: 23" H: 32" SW: 19.5" SD: 18" SH: 18.5" AH: - WT: 17 lb COM: .8 yd WT CAP: 300 lb

ZONE	B/COM	C	D	E	F	G	H	I	J	GENERAL INFORMATION
1	666	682	697	716	748	779	811	843	875	MATERIAL: Beech MOIS. BARR: \$5
2	682	698	713	732	764	795	827	859	891	
3	699	715	730	749	781	812	844	876	908	
4	715	731	746	765	797	828	860	892	924	



7328737 SE ARM CHAIR, UPH SEAT, UPH BARREL BACK, WOOD BACKSIDE, STACKING

W: 22" D: 23" H: 32" SW: 19.5" SD: 18" SH: 18.5" AH: 24.75" WT: 19 lb COM: .8 yd WT CAP: 300 lb

ZONE	B/COM	C	D	E	F	G	H	I	J	GENERAL INFORMATION
1	787	803	818	837	869	900	932	964	996	MATERIAL: Beech MOIS. BARR: \$5
2	806	822	837	856	888	919	951	983	1015	
3	826	842	857	876	908	939	971	1003	1035	
4	845	861	876	895	927	958	990	1022	1054	



7028739 SE SIDE CHAIR, UPH SEAT, UPH BARREL BACK, WOOD BACKSIDE, 2" WIDER, STACKING

W: 22" D: 23" H: 32" SW: 21.5" SD: 18" SH: 18.5" AH: - WT: 20 lb COM: .8 yd WT CAP: 300 lb

ZONE	B/COM	C	D	E	F	G	H	I	J	GENERAL INFORMATION
1	683	699	714	733	765	796	828	860	892	MATERIAL: Beech MOIS. BARR: \$5
2	700	716	731	750	782	813	845	877	909	
3	717	733	748	767	799	830	862	894	926	
4	733	749	764	783	815	846	878	910	942	



7328739 SE ARM CHAIR, UPH SEAT, UPH BARREL BACK, WOOD BACKSIDE, 2" WIDER, STACKING

W: 24" D: 23" H: 32" SW: 21.5" SD: 18" SH: 18.5" AH: 24.75" WT: 22 lb COM: .8 yd WT CAP: 300 lb

ZONE	B/COM	C	D	E	F	G	H	I	J	GENERAL INFORMATION
1	812	828	843	862	894	925	957	989	1021	MATERIAL: Beech MOIS. BARR: \$5
2	832	848	863	882	914	945	977	1009	1041	
3	852	868	883	902	934	965	997	1029	1061	
4	872	888	903	922	954	985	1017	1049	1081	

Specify:

- Product Number
- Wood Finish
- Fabric Vendor, Pattern and Color

See pages 16 & 17 for material and finish options.

Vantage Accessories



7074340 VANTAGE CHAIR ARMS

Beech \$162 WT: 2 lb



7070014 BOOKRACK, BACK MOUNTED

W: 14.25" D: 2.25" H: 5" WT: 1 lb

Beech \$93

For barrel back models. Cannot be used with rear-mounted cup holder accessory. Cannot be used with back mounted cup holder accessory. Cannot be used on 8731 models.



7070015 BOOKRACK, BACK MOUNTED, WITH COMMUNION CUP HOLDER

W: 13.5" D: 2.25" H: 5" WT: 1 lb

Beech \$101

For barrel back models. Cannot be used with rear-mounted cup holder accessory. Cannot be used with back mounted cup holder accessory.

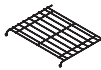

7074134 BOOKRACK, UNDERSEAT, WIRE

ID W: 17.25" ID D: 13" ID H: 3.5" WT: 2 lb

\$77

Cannot be used with kneeler 7094027. Use sliding kneeler or kneeler box. Not available on 2" wider SE models.

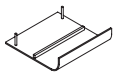

7074132 BOOKRACK, UNDERSEAT, REAR OPENING

ID W: 12" ID D: 8" ID H: 2.5" WT: 2 lb

Beech \$111

Cannot be used with kneeler 7094027. Use sliding kneeler or kneeler box. For use with standard width chair only.

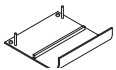

7074142 BOOKRACK, UNDERSEAT, REAR OPENING, WITH COMMUNION CUP HOLDER

ID W: 12" ID D: 8" ID H: 2.5" WT: 2 lb

Beech \$123

Cannot be used with kneeler 7094027. Use sliding kneeler or kneeler box. For use with standard width chair only.

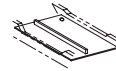

7074302 BOOKRACK, UNDERSEAT, FRONT AND REAR OPENING, WITH COMMUNION CUP HOLDER

ID W: 12.5" FD: 5.5" ID H: 2" RD: 7.5"
\$30 WT: 2 lb

Hardwood



7130340 CARD AND PENCIL HOLDER, BACK MOUNTED

ID W: 3.125" ID D: 0.375" ID H: 3.25" WT: 0.5 lb

Beech \$27

For barrel back models. Cannot be used with rear-mounted bookrack.



7130341 3-CUP HOLDER, BACK MOUNTED

Beech \$28 WT: 0.5 lb

For barrel back models. Cannot be used with rear-mounted bookrack.



7130346 CARD, 2-CUP, PENCIL HOLDER, BACK MOUNTED

ID W: 3.125" ID D: 0.375" ID H: 3.25" OD H: 4"

Beech \$79 WT: 0.5 lb

For barrel back models. Cannot be used with rear-mounted bookrack.



7094027 KNEELER, VANTAGE, UPH MOLDED FOAM PAD

W: 16.89" D: 10.5" H: 6.25" SW: - SD: - SH: - AH: - WT: 3 lb COM: .2 yd WT CAP: -

B/COM	C	D	E	F	G	H	I	J	GENERAL INFORMATION	
317	321	325	330	338	346	354	361	369	MATERIAL: Beech MOIS. BARR: -	

Not available on SE models. Use sliding kneeler or kneeler box.

Specify:

- Product Number
- Wood Finish
- Fabric Vendor, Pattern and Color

See pages 16 & 17 for material and finish options.



2022100 SIDE CHAIR, UPH FLAT SEAT, UPH BACK, STACKING

W: 20.25" D: 20.5" H: 31.75" SW: 16.5" SD: 18.5" SH: 18" AH: - WT: 16 lb COM: .6 yd WT CAP: 300 lb

ZONE	B/COM	C	D	E	F	G	H	I	J	GENERAL INFORMATION
1	492	504	515	529	553	577	601	624	648	MATERIAL: Red Oak MOIS. BARR: \$8
2	504	516	527	541	565	589	613	636	660	
3	516	528	539	553	577	601	625	648	672	WOOD SPECIE ADDER: CHERRY\$63 MAPLE\$70 BEECH\$53
4	528	540	551	565	589	613	637	660	684	



2322102 ARM CHAIR, UPH FLAT SEAT, UPH BACK, 31 3/4" HEIGHT, STACKING

W: 23.75" D: 20.5" H: 31.75" SW: 17.5" SD: 18.5" SH: 18" AH: 25.5" WT: 18 lb COM: .6 yd WT CAP: 300 lb

ZONE	B/COM	C	D	E	F	G	H	I	J	GENERAL INFORMATION
1	666	678	689	703	727	751	775	798	822	MATERIAL: Red Oak MOIS. BARR: \$8
2	682	694	705	719	743	767	791	814	838	
3	699	711	722	736	760	784	808	831	855	WOOD SPECIE ADDER: CHERRY\$63 MAPLE\$70 BEECH\$53
4	715	727	738	752	776	800	824	847	871	



4152101 SINGLE FRONTAL KNEELER, 20 INCHES WIDE (PRIE DIEU)

W: 20.25" D: 20.75" H: 32" SW: - SD: - SH: - AH: - WT: 40 lb COM: .3 yd WT CAP: -

ZONE	B/COM	C	D	E	F	G	H	I	J	GENERAL INFORMATION
1	899	905	911	918	930	941	953	965	977	MATERIAL: Red Oak MOIS. BARR: -
2	921	927	933	940	952	963	975	987	999	
3	944	950	956	963	975	986	998	1010	1022	WOOD SPECIE ADDER: CHERRY\$126 MAPLE\$141 BEECH\$130
4	966	972	978	985	997	1008	1020	1032	1044	

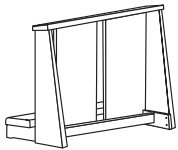

4152102 DOUBLE FRONTAL KNEELER, 40 INCHES WIDE (PRIE DIEU)

W: 40.25" D: 20.75" H: 31.75" SW: - SD: - SH: - AH: - WT: 66 lb COM: .4 yd WT CAP: -

ZONE	B/COM	C	D	E	F	G	H	I	J	GENERAL INFORMATION
1	1236	1244	1252	1262	1278	1293	1309	1325	1341	MATERIAL: Red Oak MOIS. BARR: -
2	1267	1275	1283	1293	1309	1324	1340	1356	1372	
3	1298	1306	1314	1324	1340	1355	1371	1387	1403	WOOD SPECIE ADDER: CHERRY\$173 MAPLE\$194 BEECH\$179
4	1328	1336	1344	1354	1370	1385	1401	1417	1433	

Specify:

- Product Number
- Wood Finish
- Fabric Vendor,
Pattern and Color

**See pages 16 & 17
for material and finish
options.**

Oaklok Accessories



2072100 BOOKRACK, INTERLOCKING, SINGLE

L: 11.5" D: 4.5" W: 2.25" WT: 1 lb

Red Oak \$69

WOOD SPECIE ADDER: MAPLE\$15
CHERRY\$14 BEECH\$11

Use with side chair only.



2072104 BOOKRACK, INTERLOCKING, SINGLE, EXTRA DEPTH SACK

L: 11.5" D: 9.7" W: 2.25" WT: 1 lb

Red Oak \$82

WOOD SPECIE ADDER: MAPLE\$13
CHERRY\$12 BEECH\$9

Use with side chair only.



2072108 BOOKRACK, INTERLOCKING, DOUBLE

L: 11.5" D: 4.5" W: 5" WT: 1 lb

Red Oak \$123

WOOD SPECIE ADDER: MAPLE\$28
CHERRY\$25 BEECH\$20



2072111 OAKLOK/PARAGON INTERLOCK, WOOD

Red Oak \$43 WT: 1 lb

WOOD SPECIE ADDER: MAPLE\$11
CHERRY\$10 BEECH\$8

Use with side chair only.



2072118 BOOKRACK, INTERLOCKING, SINGLE, ADJUSTABLE RADIUS

L: 10.5" D: 5" W: 2.25-3" WT: 1 lb

Red Oak \$141

WOOD SPECIE ADDER: MAPLE\$13
CHERRY\$12 BEECH\$9

Use with side chair only.



2072128 BOOKRACK, WOOD, UNDERSEAT, FRONT AND REAR OPENING, CUPHOLDER

RW: 13.38" RD: 9.25" RH: 2"
FW: 10.75" FD: 8.25" FH: 2" WT: 2 lb

Beech \$141



2072131 BOOKRACK, WOOD, UNDERSEAT, REAR OPENING, CUPHOLDER

W: 13.38" D: 9.25" H: 2" WT: 2 lb

Beech \$125



2132101 CARD AND PENCIL HOLDER, BACK MOUNTED

H: 4" W: 3.125" D: 0.4" WT: 0.5 lb

Red Oak \$28

WOOD SPECIE ADDER: MAPLE\$2
CHERRY\$2 BEECH\$1



2132102 CARD, 2-CUP, PENCIL HOLDER, BACK MOUNTED

H: 4" W: 3.125" D: 0.4" WT: 0.5 lb

Red Oak \$82

WOOD SPECIE ADDER: MAPLE\$3
CHERRY\$3 BEECH\$2



2132103 3-CUP HOLDER, BACK MOUNTED

Red Oak \$33 WT: 0.5 lb

WOOD SPECIE ADDER: MAPLE\$2
CHERRY\$2 BEECH\$1



2100 KNEELER HOLES (WITHOUT THE KNEELER) CANNOT BE ORDERED BY ITSELF

\$4

Specify:

- Product Number
- Wood Specie
- Wood Finish

See pages 16 & 17 for material and finish options.

Oaklok Accessories

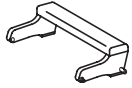

2090011 KNEELER, WOOD, WITH UPH MOLDED FOAM PAD

W: 17.89" D: 11" H: 6.25" SW: - SD: - SH: - AH: - WT: 5 lb COM: .2 yd WT CAP: -

B/COM	C	D	E	F	G	H	I	J	GENERAL INFORMATION
213	217	221	226	234	242	250	257	265	MATERIAL: Red Oak MOIS. BARR: - WOOD SPECIE ADDER: CHERRY\$24 BEECH\$19 MAPLE\$27

Use with side chairs and 2301 arm chairs.

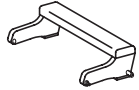

2090012 KNEELER, WOOD, WITH UPH MOLDED FOAM PAD

W: 18.89" D: 11" H: 6.25" SW: - SD: - SH: - AH: - WT: 5 lb COM: .2 yd WT CAP: -

B/COM	C	D	E	F	G	H	I	J	GENERAL INFORMATION
235	239	243	248	256	264	272	279	287	MATERIAL: Red Oak MOIS. BARR: - WOOD SPECIE ADDER: CHERRY\$25 BEECH\$20 MAPLE\$27

Use with arm chairs except 2301 styles.

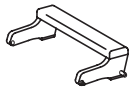

2090013 KNEELER, WOOD, WITH BOOKRACK, UPH MOLDED FOAM PAD

W: 17.89" D: 10" H: 6.25" SW: - SD: - SH: - AH: - WT: 4 lb COM: .2 yd WT CAP: -

B/COM	C	D	E	F	G	H	I	J	GENERAL INFORMATION
213	217	221	226	234	242	250	257	265	MATERIAL: Red Oak MOIS. BARR: - WOOD SPECIE ADDER: CHERRY\$24 BEECH\$19 MAPLE\$27

Use with side chairs and 2301 arm chairs with underseat bookrack.



2090014 KNEELER, WOOD, WITH BOOKRACK, UPH MOLDED FOAM PAD

W: 18.75" D: 10" H: 6.25" SW: - SD: - SH: - AH: - WT: 4 lb COM: .2 yd WT CAP: -

B/COM	C	D	E	F	G	H	I	J	GENERAL INFORMATION
235	239	243	248	256	264	272	279	287	MATERIAL: Red Oak MOIS. BARR: - WOOD SPECIE ADDER: CHERRY\$25 BEECH\$20 MAPLE\$27

Use with arm chairs with underseat bookrack except 2301 styles.

Specify:
 Product Number
 Wood Specie
 Wood Finish
 Fabric Vendor, Pattern and Color
See pages 16 & 17 for material and finish options.



3306120 SIDE CHAIR, UPH SEAT, WOOD BACK, NON-STACKING, 20"

W: 20"	D: 23"	H: 32"	SW: 20"	SD: 17.75"	SH: 18.25"	AH: -	WT: 24 lb	COM: .5 yd	WT CAP: 300 lb	
ZONE	B/COM	C	D	E	F	G	H	I	J	GENERAL INFORMATION
1	760	770	780	792	812	831	851	871	891	MATERIAL: Red Oak MOIS. BARR: -
2	779	789	799	811	831	850	870	890	910	
3	798	808	818	830	850	869	889	909	929	WOOD SPECIE ADDER: CHERRY\$149 BEECH\$140 MAPLE\$157
4	816	826	836	848	868	887	907	927	947	

Fabric application is selvage front.

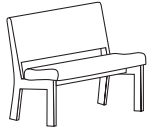

3306140 SIDE CHAIR, UPH SEAT, WOOD BACK, NON-STACKING, 40"

W: 40"	D: 23"	H: 32"	SW: 40"	SD: 17.75"	SH: 18.25"	AH: -	WT: 38 lb	COM: .9 yd	WT CAP: 450 lb	
ZONE	B/COM	C	D	E	F	G	H	I	J	GENERAL INFORMATION
1	1108	1126	1144	1165	1201	1236	1272	1307	1343	MATERIAL: Red Oak MOIS. BARR: -
2	1135	1153	1171	1192	1228	1263	1299	1334	1370	
3	1163	1181	1199	1220	1256	1291	1327	1362	1398	WOOD SPECIE ADDER: CHERRY\$203 BEECH\$195 MAPLE\$13
4	1190	1208	1226	1247	1283	1318	1354	1389	1425	

Fabric application is selvage front.

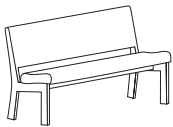

3306160 SIDE CHAIR, UPH SEAT, WOOD BACK, NON-STACKING, 60"

W: 60"	D: 23"	H: 32"	SW: 60"	SD: 17.75"	SH: 18.25"	AH: -	WT: 55 lb	COM: 1 yd	WT CAP: 675 lb	
ZONE	B/COM	C	D	E	F	G	H	I	J	GENERAL INFORMATION
1	1406	1426	1445	1469	1509	1548	1588	1627	1667	MATERIAL: Red Oak MOIS. BARR: -
2	1441	1461	1480	1504	1544	1583	1623	1662	1702	
3	1476	1496	1515	1539	1579	1618	1658	1697	1737	WOOD SPECIE ADDER: CHERRY\$252 BEECH\$245 MAPLE\$264
4	1510	1530	1549	1573	1613	1652	1692	1731	1771	

Fabric application is selvage front.

Specify:

- Product Number
- Wood Specie
- Wood Finish
- Fabric Vendor, Pattern and Color

See pages 16 & 17 for material and finish options.



3306420 SIDE CHAIR, UPH SEAT, BACK, AND BACKSIDE, NON-STACKING, 20"

W: 20" D: 23" H: 32" SW: 20" SD: 17" SH: 18.25" AH: - WT: 24 lb COM: 1 yd WT CAP: 300 lb

ZONE	B/COM	C	D	E	F	G	H	I	J	GENERAL INFORMATION
1	773	793	812	836	876	915	955	994	1034	MATERIAL: Red Oak MOIS. BARR: -
2	792	812	831	855	895	934	974	1013	1053	
3	811	831	850	874	914	953	993	1032	1072	WOOD SPECIE ADDER: CHERRY\$144 BEECH\$129
4	830	850	869	893	933	972	1012	1051	1091	MAPLE\$151

Fabric application is selvage front.

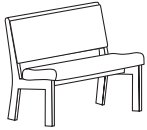

3306440 SIDE CHAIR, UPH SEAT, BACK, AND BACKSIDE, NON-STACKING, 40"

W: 40" D: 23" H: 32" SW: 40" SD: 17" SH: 18.25" AH: - WT: 39 lb COM: 1.8 yd WT CAP: 450 lb

ZONE	B/COM	C	D	E	F	G	H	I	J	GENERAL INFORMATION
1	1135	1171	1205	1248	1320	1390	1462	1533	1605	MATERIAL: Red Oak MOIS. BARR: -
2	1163	1199	1233	1276	1348	1418	1490	1561	1633	
3	1190	1226	1260	1303	1375	1445	1517	1588	1660	WOOD SPECIE ADDER: CHERRY\$192 BEECH\$175
4	1218	1254	1288	1331	1403	1473	1545	1616	1688	MAPLE\$200

Fabric application is selvage front.

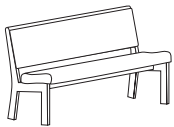

3306460 SIDE CHAIR, UPH SEAT, BACK, AND BACKSIDE, NON-STACKING, 60"

W: 60" D: 23" H: 32" SW: 60" SD: 17" SH: 18.25" AH: - WT: 55 lb COM: 2.2 yd WT CAP: 675 lb

ZONE	B/COM	C	D	E	F	G	H	I	J	GENERAL INFORMATION
1	1436	1480	1522	1575	1663	1749	1837	1922	2010	MATERIAL: Red Oak MOIS. BARR: -
2	1471	1515	1557	1610	1698	1784	1872	1957	2045	
3	1506	1550	1592	1645	1733	1819	1907	1992	2080	WOOD SPECIE ADDER: CHERRY\$235 BEECH\$215
4	1541	1585	1627	1680	1768	1854	1942	2027	2115	MAPLE\$245

Fabric application is selvage front.

Specify:

- Product Number
- Wood Specie
- Wood Finish
- Fabric Vendor, Pattern and Color

See pages 16 & 17 for material and finish options.



3306720 SIDE CHAIR, UPH SEAT AND BACK, WOOD BACKSIDE, NON-STACKING, 20"

W: 20"	D: 23"	H: 32"	SW: 20"	SD: 17"	SH: 18.25"	AH: -	WT: 25 lb	COM: .8 yd	WT CAP: 300 lb	
ZONE	B/COM	C	D	E	F	G	H	I	J	GENERAL INFORMATION
1	795	811	826	845	877	908	940	972	1004	MATERIAL: Red Oak
2	815	831	846	865	897	928	960	992	1024	MOIS. BARR: -
3	834	850	865	884	916	947	979	1011	1043	WOOD SPECIE ADDER:
4	854	870	885	904	936	967	999	1031	1063	CHERRY\$149 BEECH\$137 MAPLE\$156

Fabric application is selvage front.

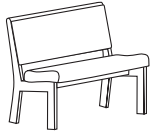

3306740 SIDE CHAIR, UPH SEAT AND BACK, WOOD BACKSIDE, NON-STACKING, 40"

W: 40"	D: 23"	H: 32"	SW: 40"	SD: 17"	SH: 18.25"	AH: -	WT: 41 lb	COM: 1.4 yd	WT CAP: 450 lb	
ZONE	B/COM	C	D	E	F	G	H	I	J	GENERAL INFORMATION
1	1153	1181	1208	1242	1298	1352	1408	1463	1519	MATERIAL: Red Oak
2	1181	1209	1236	1270	1326	1380	1436	1491	1547	MOIS. BARR: -
3	1210	1238	1265	1299	1355	1409	1465	1520	1576	WOOD SPECIE ADDER:
4	1238	1266	1293	1327	1383	1437	1493	1548	1604	CHERRY\$199 BEECH\$187 MAPLE\$208

Fabric application is selvage front.

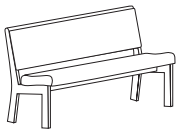

3306760 SIDE CHAIR, UPH SEAT AND BACK, WOOD BACKSIDE, NON-STACKING, 60"

W: 60"	D: 23"	H: 32"	SW: 60"	SD: 17"	SH: 18.25"	AH: -	WT: 58 lb	COM: 1.6 yd	WT CAP: 675 lb	
ZONE	B/COM	C	D	E	F	G	H	I	J	GENERAL INFORMATION
1	1453	1485	1515	1553	1617	1680	1744	1806	1870	MATERIAL: Red Oak
2	1489	1521	1551	1589	1653	1716	1780	1842	1906	MOIS. BARR: -
3	1524	1556	1586	1624	1688	1751	1815	1877	1941	WOOD SPECIE ADDER:
4	1560	1592	1622	1660	1724	1787	1851	1913	1977	CHERRY\$245 BEECH\$232 MAPLE\$256

Fabric application is selvage front.

Specify:

- Product Number
- Wood Specie
- Wood Finish
- Fabric Vendor, Pattern and Color

See pages 16 & 17 for material and finish options.

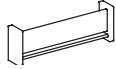

3080005 BOOKRACK, BACK MOUNT, 20

OD L: 16.88" OD D: 2.75" OD H: 5.88"
ID W: 15.25" ID D: 2.125" ID H: 4.88" WT: 1 lb
Red Oak \$56

WOOD SPECIE ADDER: MAPLE\$12
CHERRY\$11 BEECH\$8

For use on 20" Unity. If insert is ordered, it will be offset to one side, leaving a space of 9-1/8" to accommodate one book.

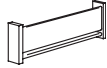

3080001 BOOKRACK, 3-BOOK, BACK MOUNT

OD L: 21.75" OD D: 2.75" OD H: 5.88"
ID W: 20.3" ID D: 2.125" ID H: 4.88" WT: 1.5 lb
Red Oak \$55

WOOD SPECIE ADDER: MAPLE\$14
CHERRY\$12 BEECH\$10

For use on 40" and 60" Unity. If insert is ordered, it will be placed in the middle. The remaining spaces will be 7" each. Price shown is when ordering with Unity. When ordering this accessory by itself, please refer to the pew pricing pages.



3080378 BOOKRACK, 4-BOOK, BACK MOUNT

OD L: 35.75" OD D: 2.75" OD H: 5.88"
ID W: 34" ID D: 2.187" ID H: 4.88" WT: 2 lb
Red Oak \$66

WOOD SPECIE ADDER: MAPLE\$22
CHERRY\$20 BEECH\$16

For use on 40" and 60" Unity. If insert is ordered, it will be placed in the middle. The remaining spaces will be 13-15/16" each. Price shown is when ordering with Unity. When ordering this accessory by itself, please refer to the pew pricing pages.



3080006 BOOKRACK, UNDERSEAT, REAR OPENING, 20

OD L: 14.75" OD D: 6.5" OD H: 3.125"
ID W: 13.125" ID D: 6.5" ID H: 2.125" WT: 1 lb
Red Oak \$56

WOOD SPECIE ADDER: MAPLE\$11
CHERRY\$10 BEECH\$8

For use on 20" Unity. Cannot be used with a kneeler.

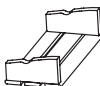

3080007 BOOKRACK, UNDERSEAT, FRONT OPENING, 20

OD L: 14.75" OD D: 6.5" OD H: 3.125"
ID W: 13.125" ID D: 6.5" ID H: 2.125" WT: 1 lb
Red Oak \$56

WOOD SPECIE ADDER: MAPLE\$11
CHERRY\$10 BEECH\$8

For use on 20" Unity.

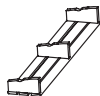

3080008 BOOKRACK, UNDERSEAT, REAR OPENING, 40/60

OD L: 34.75" OD D: 6.5" OD H: 3.5"
ID W: 33.125" ID D: 6.5" ID H: 2.125" WT: 2 lb
Red Oak \$69

WOOD SPECIE ADDER: MAPLE\$21
CHERRY\$19 BEECH\$15

For use on 40" and 60" Unity. Cannot be used with a kneeler.



3080009 BOOKRACK, UNDERSEAT, FRONT OPENING, 40/60

OD L: 34.75" OD D: 6.5" OD H: 31.25"
ID W: 33.125" ID D: 6.5" ID H: 2.125" WT: 2 lb
Red Oak \$69

WOOD SPECIE ADDER: MAPLE\$21
CHERRY\$19 BEECH\$15

For use on 40" and 60" Unity. Cannot be used with a kneeler.



3130006 INSERT, CARD, 4-CUP, PENCIL HOLDER

OD L: 6.125" OD D: 2.187" OD H: 4.125"
ID W: 4.125" ID D: 0.375" ID H: 4.125" WT: 0.5 lb
Red Oak \$24

WOOD SPECIE ADDER: MAPLE\$2
CHERRY\$2 BEECH\$1

Price shown is when ordering with Unity. When ordering this accessory by itself, please refer to the pew pricing pages.



3130007 INSERT, CARD & PENCIL HOLDER

OD L: 6.125" OD D: 2.187" OD H: 4.125"
ID W: 4.125" ID D: 0.375" ID H: 4.125" WT: 0.5 lb
Red Oak \$23

WOOD SPECIE ADDER: MAPLE\$3
CHERRY\$3 BEECH\$2

Price shown is when ordering with Unity. When ordering this accessory by itself, please refer to the pew pricing pages.



3130330 CARD, PENCIL HOLDER

OD L: 5.125" OD D: 0.75" OD H: 4.125"
ID W: 3.125" ID D: 0.375" ID H: 3.25" WT: 0.5 lb
Red Oak \$23

WOOD SPECIE ADDER: MAPLE\$3
CHERRY\$3 BEECH\$2

Cannot be used with a back-mounted bookrack on a 20" seat unit or with a 3080378 bookrack on a 40" unit. Price shown is when ordering with Unity. When ordering this accessory by itself, please refer to the pew pricing pages.



3130336 CARD, 3-CUP, PENCIL HOLDER

OD L: 5.125" OD D: 2.125" OD H: 4.125"
ID W: 3.125" ID D: 0.375" ID H: 3.25" WT: 0.5 lb
Red Oak \$33

WOOD SPECIE ADDER: MAPLE\$4
CHERRY\$4 BEECH\$3

Cannot be used with a back-mounted bookrack on a 20" seat unit or with a 3080378 bookrack on a 40" unit.



3170001 INTERLOCK

\$6 WT: 0.5 lb

Cannot be used with Unity arm models.



3170002 ANCHOR SET (SET OF FOUR)

\$11 WT: 0.5 lb

Cannot be used with stacking units. Includes 4" anchors.



2100 KNEELER HOLES (WITHOUT THE KNEELER) CANNOT BE ORDERED BY ITSELF

\$4

Specify:
 Product Number
 Wood Specie
 Wood Finish
See pages 16 & 17 for material and finish options.

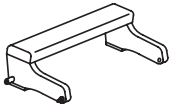

3090015 KNEELER, WOOD, UPH MOLDED FOAM PAD, 20"

W: 17.25" D: 11.25" H: 6.25" SW: - SD: - SH: - AH: - WT: 5 lb COM: .2 yd WT CAP: -

B/COM	C	D	E	F	G	H	I	J	GENERAL INFORMATION
183	187	191	196	204	212	220	227	235	MATERIAL: Red Oak MOIS. BARR: - WOOD SPECIE ADDER: CHERRY\$23 BEECH\$19 MAPLE\$26

Cannot be used with underseat rear-mounted bookracks.

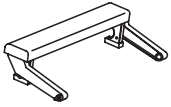

3090016 KNEELER, METAL, UPH MOLDED FOAM PAD, 20"

W: 17.25" D: 10.5" H: 6.75" SW: - SD: - SH: - AH: - WT: 5 lb COM: .2 yd WT CAP: -

B/COM	C	D	E	F	G	H	I	J	GENERAL INFORMATION
174	178	182	187	195	203	211	218	226	MATERIAL: Metal MOIS. BARR: -

Cannot be used with underseat rear mounted bookracks or stacking models. For non-stacking 20" seat.

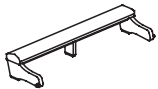

3090017 KNEELER, WOOD, UPH MOLDED FOAM PAD, 40"

W: 37.25" D: 11.25" H: 6.25" SW: - SD: - SH: - AH: - WT: 10 lb COM: .4 yd WT CAP: -

B/COM	C	D	E	F	G	H	I	J	GENERAL INFORMATION
291	299	307	317	333	348	364	380	396	MATERIAL: Red Oak MOIS. BARR: - WOOD SPECIE ADDER: CHERRY\$34 BEECH\$127 MAPLE\$38

Cannot be used with underseat rear-mounted bookracks.



3090018 KNEELER, METAL, UPH MOLDED FOAM PAD, 40"

W: 37.25" D: 10.5" H: 6.75" SW: - SD: - SH: - AH: - WT: 10 lb COM: .4 yd WT CAP: -

B/COM	C	D	E	F	G	H	I	J	GENERAL INFORMATION
265	273	281	291	307	322	338	354	370	MATERIAL: Metal MOIS. BARR: -

Cannot be used with underseat rear mounted bookracks or stacking models.

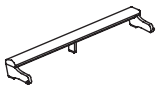

3090019 KNEELER, WOOD, UPH MOLDED FOAM PAD, 60"

W: 57.25" D: 11.25" H: 6.25" SW: - SD: - SH: - AH: - WT: 15 lb COM: .5 yd WT CAP: -

B/COM	C	D	E	F	G	H	I	J	GENERAL INFORMATION
364	374	384	396	416	435	455	475	495	MATERIAL: Red Oak MOIS. BARR: - WOOD SPECIE ADDER: CHERRY\$36 BEECH\$18 MAPLE\$35

Cannot be used with underseat rear-mounted bookracks.



3090020 KNEELER, METAL, UPH MOLDED FOAM PAD, 60"

W: 57.25" D: 10.5" H: 6.75" SW: - SD: - SH: - AH: - WT: 15 lb COM: .5 yd WT CAP: -

B/COM	C	D	E	F	G	H	I	J	GENERAL INFORMATION
331	341	351	363	383	402	422	442	462	MATERIAL: Metal MOIS. BARR: -

Cannot be used with underseat rear-mounted bookracks. Cannot be used with stacking units.

Specify:

- Product Number
- Wood Specie
- Wood Finish
- Fabric Vendor, Pattern and Color

See pages 16 & 17 for material and finish options.

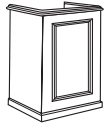

4111305 COLONIAL LECTERN, WITH ROUT, STAINED, 23"W X 30"L X 45"H

W: 23" D: 30" H: 45" WT: 115 lb

Zone	1	2	3	4
	5383	5518	5652	5787

GENERAL INFORMATION

MATERIAL: Red Oak
MOIS BARR: -

WOOD SPECIE ADDER:
CHERRY\$753 BEECH\$753
MAPLE\$862

Please note Chancel items require an extended lead time. Call for details. Additional wood species are available, including: Rift Red Oak, White Oak, White Oak Rift, Beech, Cherry, Maple, Mahogany, and Walnut. Call for details. Also available in a painted finish, use product number 4111705.

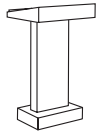

4112083 LECTERN, ADJUSTABLE HEIGHT, 19"W X 24"L X 44"47"H

W: 19" D: 24" H: 44-47" WT: 50 lb

Zone	1	2	3	4
	2919	2992	3065	3138

GENERAL INFORMATION

MATERIAL: Red Oak
MOIS BARR: -

WOOD SPECIE ADDER:
CHERRY\$407 BEECH\$407
MAPLE\$466

Please note Chancel items require an extended lead time. Call for details. Additional wood species are available, including: Rift Red Oak, White Oak, White Oak Rift, Beech, Cherry, Maple, Mahogany, and Walnut. Call for details. Non-locking casters are available.

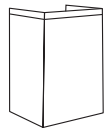

4113100 TRADITIONAL LECTERN, 23"W X 30"L X 45"H

W: 23" D: 30" H: 45" WT: 120 lb

Zone	1	2	3	4
	2692	2759	2827	2894

GENERAL INFORMATION

MATERIAL: Red Oak
MOIS BARR: -

WOOD SPECIE ADDER:
CHERRY\$378 BEECH\$378
MAPLE\$430

Please note Chancel items require an extended lead time. Call for details. Additional wood species are available, including: Rift Red Oak, White Oak, White Oak Rift, Beech, Cherry, Maple, Mahogany, and Walnut. Call for details.

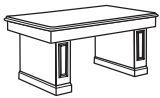

4041305 COLONIAL COMMUNION TABLE, WITH ROUT, STAINED, 30"W X 60"L X 30"H

W: 30" D: 60" H: 30" WT: 115 lb

Zone	1	2	3	4
	5828	5974	6119	6265

GENERAL INFORMATION

MATERIAL: Red Oak
MOIS BARR: -

WOOD SPECIE ADDER:
CHERRY\$817 BEECH\$817
MAPLE\$933

Please note Chancel items require an extended lead time. Call for details. Also available in a painted finish, use product number 4041705. Additional wood species are available, including: Rift Red Oak, White Oak, White Oak Rift, Beech, Cherry, Maple, Mahogany, and Walnut. Call for details.

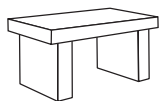

4043100 TRADITIONAL COMMUNION TABLE, 30"W X 60"L X 30"H

W: 30" D: 60" H: 30" WT: 115 lb

Zone	1	2	3	4
	3715	3808	3901	3994

GENERAL INFORMATION

MATERIAL: Red Oak
MOIS BARR: -

WOOD SPECIE ADDER:
CHERRY\$195 BEECH\$195
MAPLE\$222

Please note Chancel items require an extended lead time. Call for details. Additional wood species are available, including: Rift Red Oak, White Oak, White Oak Rift, Beech, Cherry, Maple, Mahogany, and Walnut. Call for details.



4081305 COLONIAL FLOWER STAND, WITH ROUT, STAINED, 11 1/2"W X 11 1/2"L X 24"H

W: 11.5" D: 11.5" H: 24" WT: 30 lb

Zone	1	2	3	4
	2293	2350	2408	2465

GENERAL INFORMATION

MATERIAL: Red Oak
MOIS BARR: -

WOOD SPECIE ADDER:
CHERRY\$321 BEECH\$321
MAPLE\$366

Please note Chancel items require an extended lead time. Call for details. Also available in a painted finish, use product number 4081705. Additional wood species are available, including: Rift Red Oak, White Oak, White Oak Rift, Beech, Cherry, Maple, Mahogany, and Walnut. Call for details.

Specify:

- Product Number
- Wood Specie
- Wood Finish

See pages 16 & 17 for material and finish options.



4083100 TRADITIONAL FLOWER STAND, 11 1/2"W X 11 1/2"L X 24"H

W: 11.5" D: 11.5" H: 24" WT: 35 lb

Zone	1	2	3	4
	1398	1433	1468	1503

GENERAL INFORMATION

MATERIAL: Red Oak
MOIS BARR: -

WOOD SPECIE ADDER:
CHERRY\$195 BEECH\$195
MAPLE\$222

Please note Chancel items require an extended lead time. Call for details. Additional wood species are available, including: Rift Red Oak, White Oak, White Oak Rift, Beech, Cherry, Maple, Mahogany, and Walnut. Call for details.



4083600 TRADITIONAL FLOWER STAND, 11 1/2"W X 11 1/2"L X 24"H

W: 11.5" D: 11.5" H: 24" WT: 25 lb

Zone	1	2	3	4
	1909	1957	2004	2052

GENERAL INFORMATION

MATERIAL: Red Oak
MOIS BARR: -

WOOD SPECIE ADDER:
CHERRY\$266 BEECH\$266
MAPLE\$303

Please note Chancel items require an extended lead time. Call for details. Additional wood species are available, including: Rift Red Oak, White Oak, White Oak Rift, Beech, Cherry, Maple, Mahogany, and Walnut. Call for details.

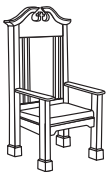

4321305 COLONIAL CLERGY ARM CHAIR, 25 1/8"W X 19 1/4"L X 42"H

W: 25.13" D: 19.25" H: 42" SW: - SD: - SH: - AH: - WT: 45 lb COM: 1.25 yd WT CAP: -

ZONE	B/COM	C	D	E	F	G	H	I	J
1	5486	5511	5535	5565	5615	5664	5714	5762	5812
2	5623	5648	5672	5702	5752	5801	5851	5899	5949
3	5759	5784	5808	5838	5888	5937	5987	6035	6085
4	5896	5921	5945	5975	6025	6074	6124	6172	6222

GENERAL INFORMATION

MATERIAL: Red Oak
MOIS. BARR: -

WOOD SPECIE ADDER:
CHERRY\$766 BEECH\$766
MAPLE\$874

Please note Chancel items require an extended lead time. Call for details. Also available in a painted finish, use product number 4321705. Additional wood species are available, including: Rift Red Oak, White Oak, White Oak Rift, Beech, Cherry, Maple, Mahogany, and Walnut. Call for details.

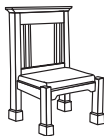

4021305 COLONIAL CLERGY SIDE CHAIR, STAINED, 25 1/8"W X 19 1/4"L X 39"H

W: 25.13" D: 19.25" H: 39" SW: - SD: - SH: - AH: - WT: 37 lb COM: 1.25 yd WT CAP: -

ZONE	B/COM	C	D	E	F	G	H	I	J
1	4522	4547	4571	4601	4651	4700	4750	4798	4848
2	4635	4660	4684	4714	4764	4813	4863	4911	4961
3	4747	4772	4796	4826	4876	4925	4975	5023	5073
4	4860	4885	4909	4939	4989	5038	5088	5136	5186

GENERAL INFORMATION

MATERIAL: Red Oak
MOIS. BARR: -

WOOD SPECIE ADDER:
CHERRY\$630 BEECH\$630
MAPLE\$721

Please note Chancel items require an extended lead time. Call for details. Also available in a painted finish, use product number 4021705. Additional wood species are available, including: Rift Red Oak, White Oak, White Oak Rift, Beech, Cherry, Maple, Mahogany, and Walnut. Call for details.

Specify:

- Product Number
- Wood Specie
- Wood Finish
- Fabric Vendor, Pattern and Color

See pages 16 & 17 for material and finish options.



4323100 TRADITIONAL CLERGY ARM CHAIR, 25 1/8"W X 19 1/4"L X 42"H

W: 25.13" D: 19.25" H: 42" SW: - SD: - SH: - AH: - WT: 30 lb COM: 1.25 yd WT CAP: -

ZONE	B/COM	C	D	E	F	G	H	I	J	GENERAL INFORMATION
1	4414	4439	4463	4493	4543	4592	4642	4690	4740	MATERIAL: Red Oak MOIS. BARR: -
2	4524	4549	4573	4603	4653	4702	4752	4800	4850	
3	4634	4659	4683	4713	4763	4812	4862	4910	4960	WOOD SPECIE ADDER: CHERRY\$444 BEECH\$444
4	4744	4769	4793	4823	4873	4922	4972	5020	5070	MAPLE\$506

Please note Chancel items require an extended lead time. Call for details. Additional wood species are available, including: Rift Red Oak, White Oak, White Oak Rift, Beech, Cherry, Maple, Mahogany, and Walnut. Call for details.



4023100 TRADITIONAL CLERGY SIDE CHAIR, 25 1/8"W X 19 1/4"L X 39"H

W: 25.13" D: 19.25" H: 39" SW: - SD: - SH: - AH: - WT: 30 lb COM: 1.25 yd WT CAP: -

ZONE	B/COM	C	D	E	F	G	H	I	J	GENERAL INFORMATION
1	2942	2967	2991	3021	3071	3120	3170	3218	3268	MATERIAL: Red Oak MOIS. BARR: -
2	3015	3040	3064	3094	3144	3193	3243	3291	3341	
3	3088	3113	3137	3167	3217	3266	3316	3364	3414	WOOD SPECIE ADDER: CHERRY\$410 BEECH\$410
4	3161	3186	3210	3240	3290	3339	3389	3437	3487	MAPLE\$467

Please note Chancel items require an extended lead time. Call for details. Additional wood species are available, including: Rift Red Oak, White Oak, White Oak Rift, Beech, Cherry, Maple, Mahogany, and Walnut. Call for details.



4011305 COLONIAL ALTAR, CLOSED, WITH ROUT, STAINED, 30"W X 72"L X 39"H

W: 30" D: 72" H: 39" WT: 220 lb

Zone	1	2	3	4
	7331	7514	7698	7881

GENERAL INFORMATION

MATERIAL: Red Oak
MOIS BARR: -

WOOD SPECIE ADDER:
CHERRY\$1027 BEECH\$1027
MAPLE\$1173

Please note Chancel items require an extended lead time. Call for details. Also available in a painted finish, use product number 4011705. Additional wood species are available, including: Rift Red Oak, White Oak, White Oak Rift, Beech, Cherry, Maple, Mahogany, and Walnut. Call for details.

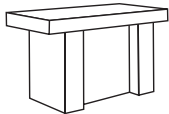

4013100 TRADITIONAL ALTAR, CLOSED, 30"W X 72"L X 39"H

W: 30" D: 72" H: 39" WT: 195 lb

Zone	1	2	3	4
	5841	5987	6133	6279

GENERAL INFORMATION

MATERIAL: Red Oak
MOIS BARR: -

WOOD SPECIE ADDER:
CHERRY\$818 BEECH\$818
MAPLE\$936

Please note Chancel items require an extended lead time. Call for details. Additional wood species are available, including: Rift Red Oak, White Oak, White Oak Rift, Beech, Cherry, Maple, Mahogany, and Walnut. Call for details.

Specify:

- Product Number
- Wood Specie
- Wood Finish
- Fabric Vendor, Pattern and Color

See pages 16 & 17 for material and finish options.

Additional Chapel Product Accessories



7094031 KNEELER, SLIDING, UPH MOLDED FOAM PAD

W: 14.4" D: 20.6" H: 6.25" SW: - SD: - SH: - AH: - WT: 4 lb COM: .2 yd WT CAP: -

B/COM	C	D	E	F	G	H	I	J	GENERAL INFORMATION
281	285	289	294	302	310	318	325	333	MATERIAL: Beech MOIS. BARR: -

Fits Horizon, Laurelwood, Plylok, Wedgewood and Vantage SE.

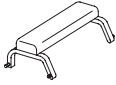

7094038 KNEELER, PLYLOK, UPH MOLDED FOAM PAD

W: 16.25" D: 11.25" H: 6.25" SW: - SD: - SH: - AH: - WT: 3 lb COM: .2 yd WT CAP: -

B/COM	C	D	E	F	G	H	I	J	GENERAL INFORMATION
317	321	325	330	338	346	354	361	369	MATERIAL: Beech MOIS. BARR: -

Specify:

- Product Number
- Wood Specie
- Wood Finish
- Fabric Vendor, Pattern and Color

See pages 16 & 17 for material and finish options.

Additional Chapel Product Accessories



7074105 BOOKRACK, BACK MOUNTED

ID W: 12.75" ID D: 2.5" ID H: 5" WT: 2 lb
\$129

For use with standard width chair only. Cannot be used with rear-mounted cup holder accessory. Cannot be used with back mounted cup holder accessory.



7074132 BOOKRACK, UNDERSEAT, REAR OPENING

ID W: 12" ID D: 8" ID H: 2.5" WT: 2 lb
\$111

Cannot be used with kneeler 7094027. Use sliding kneeler or kneeler box. For use with standard width chair only.



7074152 BOOKRACK, UNDERSEAT, FRONT OPENING

ID W: 12" ID D: 8" ID H: 2.38" WT: 2 lb
\$106

Cannot be used with a kneeler. For use with standard width chair only.



7074162 BOOKRACK, UNDERSEAT, FRONT AND REAR OPENING

RW: 12" RD: 8" RH: 2.5"
FW: 10.75" FD: 5.75" FH: 2.25" WT: 2 lb
\$134

Cannot be used with kneeler 7094027. Use sliding kneeler or kneeler box. For use with standard width chair only.



7074303 BOOKRACK, UNDERSEAT, REAR OPENING, WITH COMMUNION CUP

ID W: 12" ID D: 7.5" ID H: 2.25" WT: 2 lb
\$30

For use with standard width chair only. Hardwood.



7144014 T MOLD RUNNER (SET OF TWO)

\$39 WT: 0.5 lb

Available for 2- and 3-position and sledbase chairs.



7130356 CARD, 2-CUP, PENCIL HOLDER, BACK MOUNTED

ID W: 3.125" ID D: 0.375" ID H: 3.25" WT: 0.5 lb
\$88

Cannot be used with a back mounted bookrack or on ladder backs.

7032000 UNIVERSAL 2-WHEEL CART

W: -	D: -	H: -	WT: 37 lb
Zone 1	Zone 2	Zone 3	Zone 4
\$1028	\$1054	\$1079	\$1105

Cart holds 8 side chairs and 7 arm chairs.



7074129 INTERLOCK, METAL, STRAIGHT

\$8 WT: 0.5 lb

Female interlock is mounted on right leg. Male interlock is mounted on left leg. See chair reference chart below for more information on usage.



7074130 INTERLOCK, METAL, RADIUS

\$43 WT: 0.5 lb

Female interlock is mounted on right leg. Male interlock is mounted on left leg. See chair reference chart below for more information on usage.

Interlock Reference Chart

Chair	7074129 Straight			7074130 Radius		
	S to S	S to A	A to A	S to S	S to A	A to A
Oaklok	Yes*	No	No	Yes	Yes	No
PlyFold	Yes	-	-	No	-	-
PlyLok	Yes	No	No	Yes	Yes	Yes
Unity non-stacking**	Yes	No	No	Yes	No	No
Unity stacking	Yes	No	No	No	No	No
Vantage***	Yes	Yes	Yes	Yes	Yes	No
Vantage SE***	Yes	Yes	Yes	Yes	Yes	No

GLIDES:

Available for Oaklok, PlyFold, PlyLok, Unity®, Vantage, Vantage SE

STRAIGHT INTERLOCKS:

Available for Oaklok, PlyFold, 4-leg PlyLok, Unity®, Vantage

RADIUS INTERLOCKS:

Available for Oaklok, 4-leg PlyLok, PlyLok "L" arm chairs, Unity®, Vantage

Please Note: Different product lines are not intended to be interlocked with each other.

S to S = Can be used to attach a side chair to a side chair.
S to A = Can be used to attach a side chair to an arm chair.
A to A = Can be used to attach an arm chair to an arm chair.

*Oaklok requires two sets per chair.

**On non-stacking Unity the min. radius is 3 feet.

***Vantage Arm chairs with interlocks cannot stack more than 2 chairs high.

Specify:

Product Number

Wood Finish

See pages 16 & 17 for material and finish options.



WIELAND
healthcare

10785 Rose Ave.
New Haven, IN 46774

888.WIELAND f: 260.627.6496
wielandhealthcare.com

©2024 Sauder Manufacturing Co.

HC04061012