

**CLASSIC (FULL FRONT)**

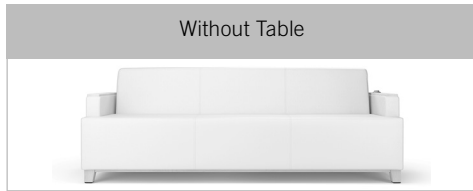

621 Series



621T Series

**CUSTOM (SEAT CUSHION WITH BASE OPTIONS)**



622 Series



622T Series

**ARM CAP OPTIONS**



Upholstered  
(no upcharge)

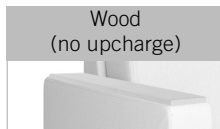

Wood  
(no upcharge)

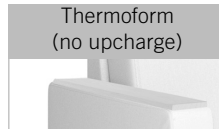

Thermoform  
(no upcharge)



Urethane  
(no upcharge)

Specify black, sable or dove.



Solid Surface  
\$340

Specify solid surface color.

**LEG STYLES**

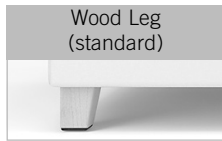

Wood Leg  
(standard)

There is no wood trim rail on custom models.



Metal Leg  
\$514

Specify silver, black, bronze or gunmetal.



Casters  
\$555

Available with or without a table. For table models, specify wood or metal center feet. Casters are intended to aid housekeeping staff with moving when cleaning.



■ = table base  
● = casters ■ = foot

**BASE OPTIONS - FOR CUSTOM STYLES ONLY**



Ottoman  
\$1102

Specify left or right and select wood or urethane handle (as facing).



Drawer - Fabric, Wood or Thermoform  
\$442

Specify left, middle or right.

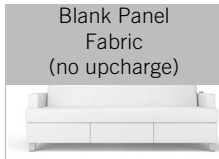

Blank Panel  
Fabric  
(no upcharge)

Specify left, middle or right.



Blank Panel  
Wood or Thermoform  
\$116

Specify left, middle or right.

**POWER OPTIONS - FOR CLASSIC STYLE WITH TABLE AND CUSTOM STYLE WITH TABLE ONLY**



120V/ USB A+C  
Outlet \$829

Available in black or silver. Usable cord length is 9'. Please get facility approval on power options before ordering. Specify right, left, or both. Power units are UL Listed Tamper Resistant outlets.

**SLEEP SURFACE OPTIONS**

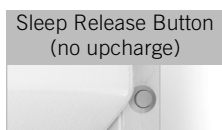

Sleep Release Button  
(no upcharge)

Specify dark bronze, light grey or black. Specify right or left (right is default unless otherwise specified).

**TABLE OPTIONS**

Thermoform Table Top  
(no upcharge)



*Specify thermoform color.*

Solid Surface Table Top



*Specify solid surface color.*

63" .....	\$708
66" .....	\$947
69" .....	\$1196
72" .....	\$1345
75" .....	\$1709
78" .....	\$1823

Wood Column Skirt  
Cap (no upcharge)

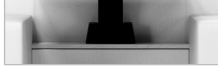

*Specify wood finish.*

Thermoform Column  
Skirt Cap (no upcharge)



*Specify thermoform color.*

Solid Surface Skirt Cap

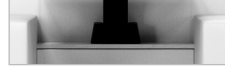

*Specify solid surface color.*

63" .....	\$266
66" .....	\$349
69" .....	\$352
72" .....	\$352
75" .....	\$435
78" .....	\$435

Table Release Lever  
(no upcharge)



*Specify silver, black, bronze or gunmetal.*

OPTIONS LEGEND

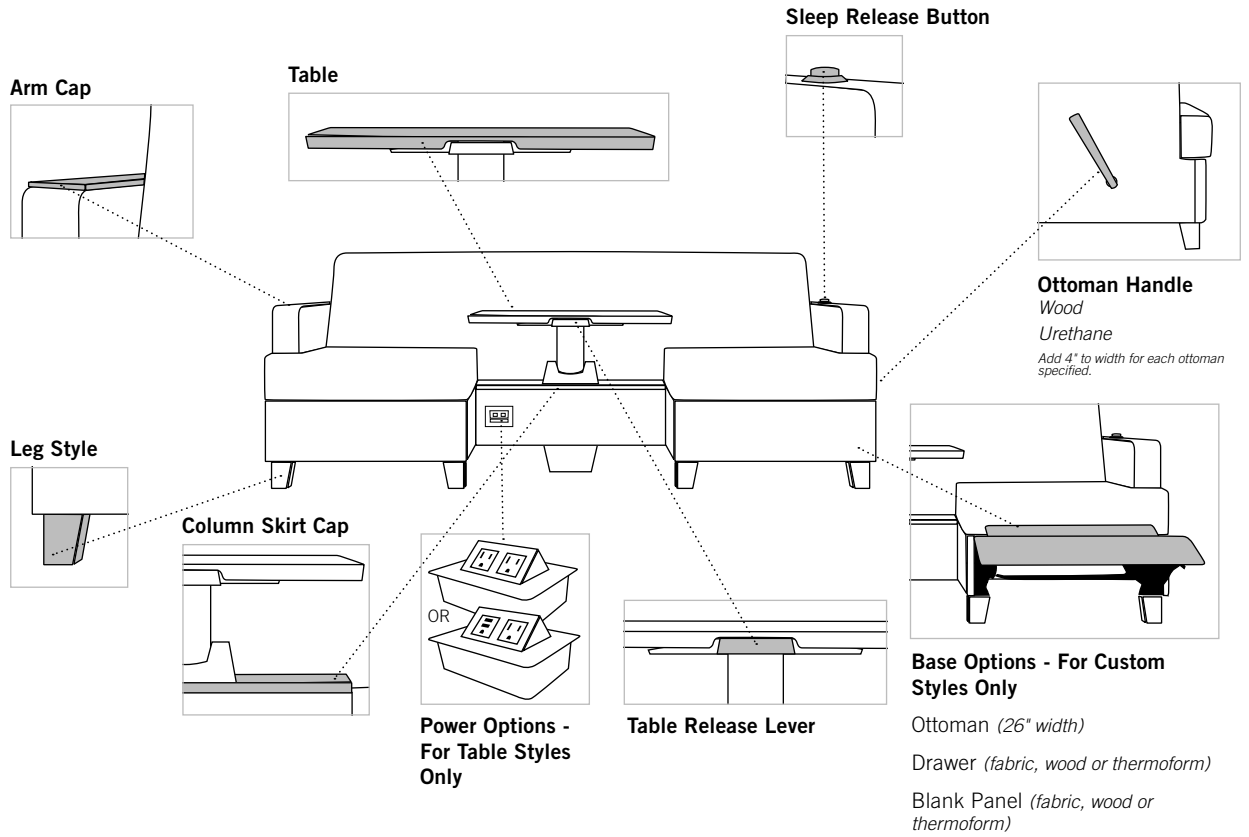

# sleepToo® Classic

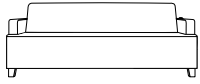

## 62166 SLEEP SOFA, CLASSIC FRONT, 66" SLEEP SURFACE

W: 74" D: 34" H: 33" SW: 66" SD: 21.5" SH: 18.5" AH: 24.5" WT: 172 lb COM: 8.25 yd WT CAP: 750 lb

ZONE	B/COM	C	D	E	F	G	H	I	J	GENERAL INFORMATION
1	9535	9700	9857	10055	10385	10707	11037	11358	11688	MATERIAL: Maple MOIS. BARR: Included
2	9770	9935	10092	10290	10620	10942	11272	11593	11923	
3	10005	10170	10327	10525	10855	11177	11507	11828	12158	
4	10240	10405	10562	10760	11090	11412	11742	12063	12393	

## 62169 SLEEP SOFA, CLASSIC FRONT, 69" SLEEP SURFACE

W: 77" D: 34" H: 33" SW: 69" SD: 21.5" SH: 18.5" AH: 24.5" WT: 178 lb COM: 8.25 yd WT CAP: 750 lb

ZONE	B/COM	C	D	E	F	G	H	I	J	GENERAL INFORMATION
1	9660	9825	9982	10180	10510	10832	11162	11483	11813	MATERIAL: Maple MOIS. BARR: Included
2	9898	10063	10220	10418	10748	11070	11400	11721	12051	
3	10136	10301	10458	10656	10986	11308	11638	11959	12289	
4	10375	10540	10697	10895	11225	11547	11877	12198	12528	

## 62172 SLEEP SOFA, CLASSIC FRONT, 72" SLEEP SURFACE

W: 80" D: 34" H: 33" SW: 72" SD: 21.5" SH: 18.5" AH: 24.5" WT: 184 lb COM: 8.25 yd WT CAP: 750 lb

ZONE	B/COM	C	D	E	F	G	H	I	J	GENERAL INFORMATION
1	9797	9962	10119	10317	10647	10969	11299	11620	11950	MATERIAL: Maple MOIS. BARR: Included
2	10039	10204	10361	10559	10889	11211	11541	11862	12192	
3	10280	10445	10602	10800	11130	11452	11782	12103	12433	
4	10522	10687	10844	11042	11372	11694	12024	12345	12675	

## 62175 SLEEP SOFA, CLASSIC FRONT, 75" SLEEP SURFACE

W: 83" D: 34" H: 33" SW: 75" SD: 21.5" SH: 18.5" AH: 24.5" WT: 190 lb COM: 8.25 yd WT CAP: 750 lb

ZONE	B/COM	C	D	E	F	G	H	I	J	GENERAL INFORMATION
1	9922	10087	10244	10442	10772	11094	11424	11745	12075	MATERIAL: Maple MOIS. BARR: Included
2	10167	10332	10489	10687	11017	11339	11669	11990	12320	
3	10412	10577	10734	10932	11262	11584	11914	12235	12565	
4	10656	10821	10978	11176	11506	11828	12158	12479	12809	

## 62178 SLEEP SOFA, CLASSIC FRONT, 78" SLEEP SURFACE

W: 86" D: 34" H: 33" SW: 78" SD: 21.5" SH: 18.5" AH: 24.5" WT: 196 lb COM: 8.25 yd WT CAP: 750 lb

ZONE	B/COM	C	D	E	F	G	H	I	J	GENERAL INFORMATION
1	10054	10219	10376	10574	10904	11226	11556	11877	12207	MATERIAL: Maple MOIS. BARR: Included
2	10302	10467	10624	10822	11152	11474	11804	12125	12455	
3	10550	10715	10872	11070	11400	11722	12052	12373	12703	
4	10798	10963	11120	11318	11648	11970	12300	12621	12951	

**Specify:**

- Product Number
- Wood Finish
- Urethane Color
- Fabric Vendor, Pattern and Color
- Thermoform Finish
- Metal Finish
- Arm Cap Style
- Leg Style
- Sleep Release Button (Left or Right, Color and Location)
- USB/Power Option

See pages 16 & 17 for material and finish options.

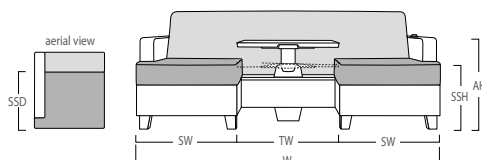

SSH- Sleep surface height 25"  
 SSD- Sleep surface depth 30"  
 SH- Seat height  
 SW- Seat width  
 W- Overall width  
 Add 4" to overall width for each ottoman specified.

# sleepToo® Classic with Table

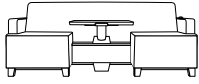

## 62163T SLEEP SOFA, CLASSIC FRONT, WITH TABLE, 63" SLEEP SURFACE

W: 71" D: 34" H: 33" SW: 22.5" SD: 21.5" SH: 18.5" AH: 24.5" WT: 211 lb COM: 7.75 yd WT CAP: 750 lb

ZONE	B/COM	C	D	E	F	G	H	I	J	GENERAL INFORMATION
1	12554	12709	12856	13042	13352	13655	13965	14267	14577	MATERIAL: Maple MOIS. BARR: Included
2	12865	13020	13167	13353	13663	13966	14276	14578	14888	
3	13176	13331	13478	13664	13974	14277	14587	14889	15199	
4	13486	13641	13788	13974	14284	14587	14897	15199	15509	

Power is not available on 63" model.

## 62166T SLEEP SOFA, CLASSIC FRONT, WITH TABLE, 66" SLEEP SURFACE

W: 74" D: 34" H: 33" SW: 22.5" SD: 21.5" SH: 18.5" AH: 24.5" WT: 216 lb COM: 7.75 yd WT CAP: 750 lb

ZONE	B/COM	C	D	E	F	G	H	I	J	GENERAL INFORMATION
1	12963	13118	13265	13451	13761	14064	14374	14676	14986	MATERIAL: Maple MOIS. BARR: Included
2	13284	13439	13586	13772	14082	14385	14695	14997	15307	
3	13605	13760	13907	14093	14403	14706	15016	15318	15628	
4	13926	14081	14228	14414	14724	15027	15337	15639	15949	

## 62169T SLEEP SOFA, CLASSIC FRONT, WITH TABLE, 69" SLEEP SURFACE

W: 77" D: 34" H: 33" SW: 22.5" SD: 21.5" SH: 18.5" AH: 24.5" WT: 221 lb COM: 7.75 yd WT CAP: 750 lb

ZONE	B/COM	C	D	E	F	G	H	I	J	GENERAL INFORMATION
1	13092	13247	13394	13580	13890	14193	14503	14805	15115	MATERIAL: Maple MOIS. BARR: Included
2	13416	13571	13718	13904	14214	14517	14827	15129	15439	
3	13740	13895	14042	14228	14538	14841	15151	15453	15763	
4	14065	14220	14367	14553	14863	15166	15476	15778	16088	

## 62172T SLEEP SOFA, CLASSIC FRONT, WITH TABLE, 72" SLEEP SURFACE

W: 80" D: 34" H: 33" SW: 22.5" SD: 21.5" SH: 18.5" AH: 24.5" WT: 226 lb COM: 7.75 yd WT CAP: 750 lb

ZONE	B/COM	C	D	E	F	G	H	I	J	GENERAL INFORMATION
1	13229	13384	13531	13717	14027	14330	14640	14942	15252	MATERIAL: Maple MOIS. BARR: Included
2	13557	13712	13859	14045	14355	14658	14968	15270	15580	
3	13884	14039	14186	14372	14682	14985	15295	15597	15907	
4	14212	14367	14514	14700	15010	15313	15623	15925	16235	

## 62175T SLEEP SOFA, CLASSIC FRONT, WITH TABLE, 75" SLEEP SURFACE

W: 83" D: 34" H: 33" SW: 22.5" SD: 21.5" SH: 18.5" AH: 24.5" WT: 231 lb COM: 7.75 yd WT CAP: 750 lb

ZONE	B/COM	C	D	E	F	G	H	I	J	GENERAL INFORMATION
1	13361	13516	13663	13849	14159	14462	14772	15074	15384	MATERIAL: Maple MOIS. BARR: Included
2	13692	13847	13994	14180	14490	14793	15103	15405	15715	
3	14023	14178	14325	14511	14821	15124	15434	15736	16046	
4	14354	14509	14656	14842	15152	15455	15765	16067	16377	

## 62178T SLEEP SOFA, CLASSIC FRONT, WITH TABLE, 78" SLEEP SURFACE

W: 86" D: 34" H: 33" SW: 22.5" SD: 21.5" SH: 18.5" AH: 24.5" WT: 236 lb COM: 7.75 yd WT CAP: 750 lb

ZONE	B/COM	C	D	E	F	G	H	I	J	GENERAL INFORMATION
1	13500	13655	13802	13988	14298	14601	14911	15213	15523	MATERIAL: Maple MOIS. BARR: Included
2	13834	13989	14136	14322	14632	14935	15245	15547	15857	
3	14169	14324	14471	14657	14967	15270	15580	15882	16192	
4	14503	14658	14805	14991	15301	15604	15914	16216	16526	

**Specify:**

- Product Number
- Wood Finish
- Urethane Color
- Fabric Vendor, Pattern and Color
- Thermoform Finish
- Metal Finish
- Arm Cap Style
- Leg Style
- Sleep Release Button (Left or Right, Color and Location)
- USB/Power Option

See pages 16 & 17 for material and finish options.

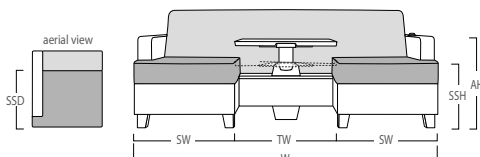

SSH- Sleep surface height 25"  
 SSD- Sleep surface depth 30"  
 SH- Seat height  
 SW- Seat width  
 W- Overall width  
 Add 4" to overall width for each ottoman specified.

# sleepToo® Custom

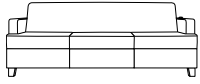

## 62266 SLEEP SOFA, CUSTOM FRONT, 66" SLEEP SURFACE

W: 74" D: 34" H: 33" SW: 66" SD: 21.5" SH: 18.5" AH: 24.5" WT: 174 lb COM: 9 yd WT CAP: 750 lb

ZONE	B/COM	C	D	E	F	G	H	I	J	GENERAL INFORMATION
1	9559	9739	9910	10126	10486	10837	11197	11548	11908	MATERIAL: Maple MOIS. BARR: Included
2	9794	9974	10145	10361	10721	11072	11432	11783	12143	
3	10030	10210	10381	10597	10957	11308	11668	12019	12379	
4	10265	10445	10616	10832	11192	11543	11903	12254	12614	

## 62269 SLEEP SOFA, CUSTOM FRONT, 69" SLEEP SURFACE

W: 77" D: 34" H: 33" SW: 69" SD: 21.5" SH: 18.5" AH: 24.5" WT: 180 lb COM: 9 yd WT CAP: 750 lb

ZONE	B/COM	C	D	E	F	G	H	I	J	GENERAL INFORMATION
1	9693	9873	10044	10260	10620	10971	11331	11682	12042	MATERIAL: Maple MOIS. BARR: Included
2	9932	10112	10283	10499	10859	11210	11570	11921	12281	
3	10170	10350	10521	10737	11097	11448	11808	12159	12519	
4	10409	10589	10760	10976	11336	11687	12047	12398	12758	

## 62272 SLEEP SOFA, CUSTOM FRONT, 72" SLEEP SURFACE

W: 80" D: 34" H: 33" SW: 72" SD: 21.5" SH: 18.5" AH: 24.5" WT: 186 lb COM: 9 yd WT CAP: 750 lb

ZONE	B/COM	C	D	E	F	G	H	I	J	GENERAL INFORMATION
1	9820	10000	10171	10387	10747	11098	11458	11809	12169	MATERIAL: Maple MOIS. BARR: Included
2	10062	10242	10413	10629	10989	11340	11700	12051	12411	
3	10304	10484	10655	10871	11231	11582	11942	12293	12653	
4	10546	10726	10897	11113	11473	11824	12184	12535	12895	

## 62275 SLEEP SOFA, CUSTOM FRONT, 75" SLEEP SURFACE

W: 83" D: 34" H: 33" SW: 75" SD: 21.5" SH: 18.5" AH: 24.5" WT: 192 lb COM: 9 yd WT CAP: 750 lb

ZONE	B/COM	C	D	E	F	G	H	I	J	GENERAL INFORMATION
1	9950	10130	10301	10517	10877	11228	11588	11939	12299	MATERIAL: Maple MOIS. BARR: Included
2	10195	10375	10546	10762	11122	11473	11833	12184	12544	
3	10440	10620	10791	11007	11367	11718	12078	12429	12789	
4	10685	10865	11036	11252	11612	11963	12323	12674	13034	

## 62278 SLEEP SOFA, CUSTOM FRONT, 78" SLEEP SURFACE

W: 86" D: 34" H: 33" SW: 78" SD: 21.5" SH: 18.5" AH: 24.5" WT: 198 lb COM: 9 yd WT CAP: 750 lb

ZONE	B/COM	C	D	E	F	G	H	I	J	GENERAL INFORMATION
1	10080	10260	10431	10647	11007	11358	11718	12069	12429	MATERIAL: Maple MOIS. BARR: Included
2	10328	10508	10679	10895	11255	11606	11966	12317	12677	
3	10577	10757	10928	11144	11504	11855	12215	12566	12926	
4	10825	11005	11176	11392	11752	12103	12463	12814	13174	

**Specify:**

- Product Number
- Wood Finish
- Urethane Color
- Fabric Vendor, Pattern and Color
- Thermoform Finish
- Metal Finish
- Arm Cap Style
- Leg Style
- Sleep Release Button (Left or Right, Color and Location)
- USB/Power Option

See pages 16 & 17 for material and finish options.

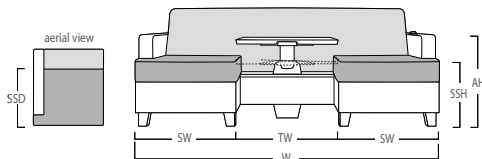

SSH- Sleep surface height 25"  
 SSD- Sleep surface depth 30"  
 SH- Seat height  
 SW- Seat width  
 W- Overall width  
 Add 4" to overall width for each ottoman specified.

# sleepToo® Custom with Table

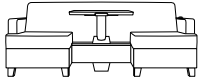

## 62263T SLEEP SOFA, CUSTOM FRONT, WITH TABLE, 63" SLEEP SURFACE

W: 71" D: 34" H: 33" SW: 22.5" SD: 21.5" SH: 18.5" AH: 24.5" WT: 215 lb COM: 8.5 yd WT CAP: 750 lb

ZONE	B/COM	C	D	E	F	G	H	I	J	GENERAL INFORMATION
1	12566	12736	12898	13102	13442	13773	14113	14445	14785	MATERIAL: Maple MOIS. BARR: Included
2	12877	13047	13209	13413	13753	14084	14424	14756	15096	
3	13188	13358	13520	13724	14064	14395	14735	15067	15407	
4	13498	13668	13830	14034	14374	14705	15045	15377	15717	

Power is not available on 63" model.

## 62266T SLEEP SOFA, CUSTOM FRONT, WITH TABLE, 66" SLEEP SURFACE

W: 74" D: 34" H: 33" SW: 22.5" SD: 21.5" SH: 18.5" AH: 24.5" WT: 220 lb COM: 8.5 yd WT CAP: 750 lb

ZONE	B/COM	C	D	E	F	G	H	I	J	GENERAL INFORMATION
1	12979	13149	13311	13515	13855	14186	14526	14858	15198	MATERIAL: Maple MOIS. BARR: Included
2	13300	13470	13632	13836	14176	14507	14847	15179	15519	
3	13621	13791	13953	14157	14497	14828	15168	15500	15840	
4	13942	14112	14274	14478	14818	15149	15489	15821	16161	

## 62269T SLEEP SOFA, CUSTOM FRONT, WITH TABLE, 69" SLEEP SURFACE

W: 77" D: 34" H: 33" SW: 22.5" SD: 21.5" SH: 18.5" AH: 24.5" WT: 225 lb COM: 8.5 yd WT CAP: 750 lb

ZONE	B/COM	C	D	E	F	G	H	I	J	GENERAL INFORMATION
1	13118	13288	13450	13654	13994	14325	14665	14997	15337	MATERIAL: Maple MOIS. BARR: Included
2	13443	13613	13775	13979	14319	14650	14990	15322	15662	
3	13767	13937	14099	14303	14643	14974	15314	15646	15986	
4	14092	14262	14424	14628	14968	15299	15639	15971	16311	

## 62272T SLEEP SOFA, CUSTOM FRONT, WITH TABLE, 72" SLEEP SURFACE

W: 80" D: 34" H: 33" SW: 22.5" SD: 21.5" SH: 18.5" AH: 24.5" WT: 230 lb COM: 8.5 yd WT CAP: 750 lb

ZONE	B/COM	C	D	E	F	G	H	I	J	GENERAL INFORMATION
1	13247	13417	13579	13783	14123	14454	14794	15126	15466	MATERIAL: Maple MOIS. BARR: Included
2	13575	13745	13907	14111	14451	14782	15122	15454	15794	
3	13903	14073	14235	14439	14779	15110	15450	15782	16122	
4	14230	14400	14562	14766	15106	15437	15777	16109	16449	

## 62275T SLEEP SOFA, CUSTOM FRONT, WITH TABLE, 75" SLEEP SURFACE

W: 83" D: 34" H: 33" SW: 22.5" SD: 21.5" SH: 18.5" AH: 24.5" WT: 235 lb COM: 8.5 yd WT CAP: 750 lb

ZONE	B/COM	C	D	E	F	G	H	I	J	GENERAL INFORMATION
1	13383	13553	13715	13919	14259	14590	14930	15262	15602	MATERIAL: Maple MOIS. BARR: Included
2	13714	13884	14046	14250	14590	14921	15261	15593	15933	
3	14045	14215	14377	14581	14921	15252	15592	15924	16264	
4	14377	14547	14709	14913	15253	15584	15924	16256	16596	

## 62278T SLEEP SOFA, CUSTOM FRONT, WITH TABLE, 78" SLEEP SURFACE

W: 86" D: 34" H: 33" SW: 22.5" SD: 21.5" SH: 18.5" AH: 24.5" WT: 240 lb COM: 8.5 yd WT CAP: 750 lb

ZONE	B/COM	C	D	E	F	G	H	I	J	GENERAL INFORMATION
1	13519	13689	13851	14055	14395	14726	15066	15398	15738	MATERIAL: Maple MOIS. BARR: Included
2	13854	14024	14186	14390	14730	15061	15401	15733	16073	
3	14188	14358	14520	14724	15064	15395	15735	16067	16407	
4	14523	14693	14855	15059	15399	15730	16070	16402	16742	

Specify:

- Product Number
- Wood Finish
- Urethane Color
- Fabric Vendor, Pattern and Color
- Thermoform Finish
- Metal Finish
- Arm Cap Style
- Leg Style
- Sleep Release Button (Left or Right, Color and Location)
- USB/Power Option

See pages 16 & 17 for material and finish options.

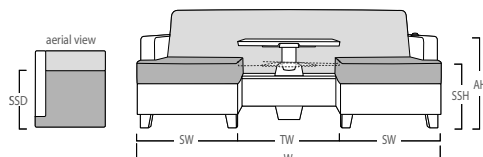

SSH- Sleep surface height 25"  
 SSD- Sleep surface depth 30"  
 SH- Seat height  
 SW- Seat width  
 W- Overall width  
 Add 4" to overall width for each ottoman specified.